

REBSTOCK®

Precision made in Germany

Mikro - Neuro - Wirbelsäule
Micro - Neuro - Spine

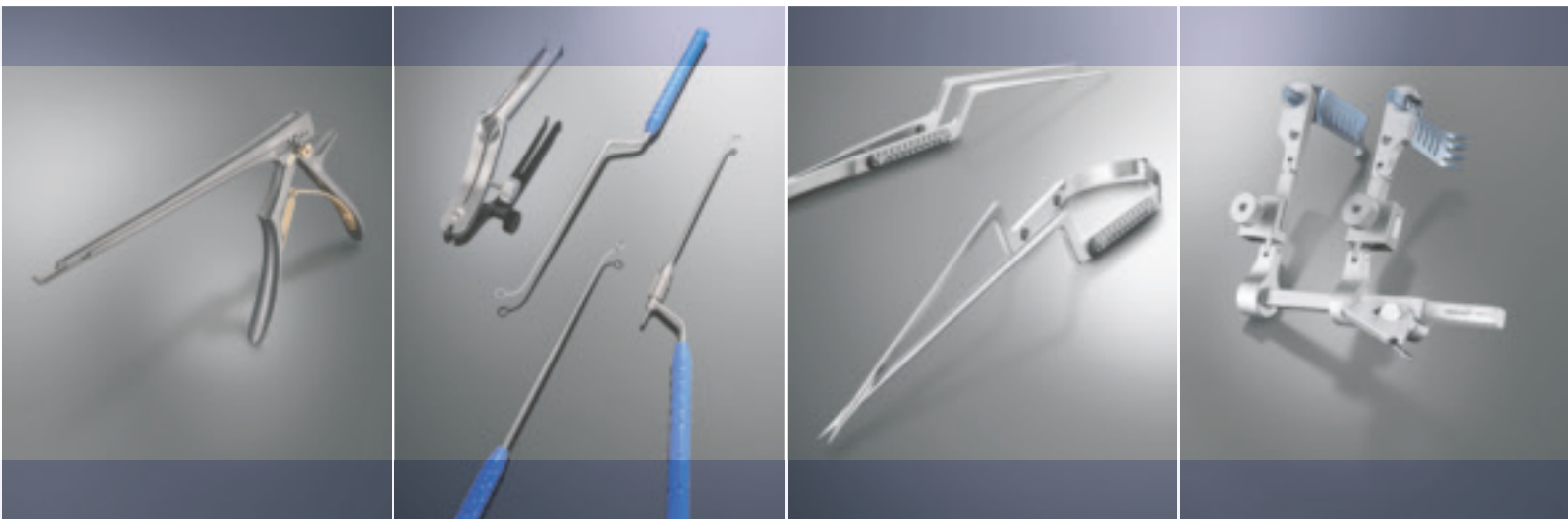

/// WILLKOMMEN BEI REBSTOCK
WELCOME TO REBSTOCK



NEUBAU 2017
NEW BUILDING 2017



Qualität Made in Germany. Hochpräzise Instrumente für mehr Sicherheit von Patienten und Operateure.

Quality Made in Germany. Highly precise instruments for more safety of patients and surgeons.

PRECISION + INNOVATION



/// **DIE KUNDEN STEHEN AN OBERSTER STELLE**
THE CUSTOMERS ARE OUR TOP PRIORITY

SERVICE + SUPPORT



Zuverlässiger Lieferservice, garantierter After Sales Service sowie kompetente und fachkundige Beratung. Ihre Zufriedenheit ist unser oberstes Ziel.

Reliable delivery service, guaranteed After Sales Service and competent expert advice. Your satisfaction is our utmost goal.



/// QUALITÄT IN DER PRODUKTION *PRODUCTION QUALITY*

Beste Rohmaterialien, modernste Technologie und qualifiziertes Fachpersonal sind unsere Gewähr für langlebige Instrumente und Implantate mit höchster Funktionalität.

Best raw materials, modern technology and qualified staff are our guarantee for durable instruments and implants with high functionality.





RESEARCH +
DEVELOPMENT

/// **DIE ZUKUNFT WIRD REALITÄT**
THE FUTURE BECOMES REALITY

Ständige Neu- und Weiterentwicklung angepasst an den medizinischen Fortschritt tragen zu einer permanenten Programmweiterung bei.

Permanent new developments and enhancements due to the medical progress are crucial for a continuously growing product portfolio.





/// **HOCHWERTIGE MEDIZINTECHNIK**
TOP-QUALITY MEDICAL TECHNOLOGY

Präzision bis ins Detail garantiert Langlebigkeit,
Sicherheit, Zuverlässigkeit und Funktionalität.

*Precision down to the last detail guarantees
durability, safety, reliability and functionality.*

COMPETENCE IN PERFECTION



/// MEHR SICHERHEIT UND TRANSPARENZ BEI DER STERILGUTVERSORGUNG

Identifikation von Instrumenten mit DATA Matrix Kennzeichnung

Auf Wunsch können alle REBSTOCK Instrumente mit DATA Matrix gekennzeichnet werden.

Diese Kennzeichnung ist für jedes Instrument individuell und beinhaltet alle notwendigen Angaben wie Hersteller- nummer, Artikelnummer und Seriennummer.

VORTEILE

- Ermöglicht die Rückverfolgung und Dokumentation bei Aufbereitungs- und Sterilisationsprozessen
- Bessere Patientensicherheit
- Überwachung des Produktlebenszyklus
- Zeitersparnis durch Maschinenlesbarkeit

/// MORE SECURITY AND TRANSPARENCY FOR YOUR ENTIRE STERILIZATION PROCESS

Identification of instruments – DATA-Matrix

On request all REBSTOCK instruments can be marked with a DATA Matrix code.

This coding is individual for every instrument and includes all necessary information like manufacturer number, article number and lot number.

ADVANTAGES

- *Assures the traceability and documentation during cleaning and sterilization processes*
- *Enhanced patient safety*
- *Control of the product life cycle*
- *Machine readability saves time*



DATA MATRIX

02

HF-Instrumente und Zubehör
HF Instruments and Accessoires

03

Kopf-Schädelinstrumente und Haltesysteme
Head-Cranio Instruments and Holding Systems

04

Aneurysmen-Clip System
Aneurysm Clip System

05

Schädel-Verplattung
Cranial Plate System

06

Hypophysektomie-Instrumente
Pituitary Instruments

07

Instrumente für die Wirbelsäule, Wundspreizer
Spine Instruments, Self-retaining Retractors

08

Laminektomie-Stanzen, Rongeurs, Hohlmeißelzangen
Laminectomy Punches, Rongeurs

09

Gefäß- und Bulldogklemmen, Gefäß-Clips
Vessel- and Bulldog-Clamps, Vessel Clips

10

Allgemeinchirurgische Instrumente
General Surgical Instruments

11

Alphabetischer Index, Numerischer Index
Alphabetical Index, Numerical Index

// 01



SURGICAL
INSTRUMENTS
MICRO-NEURO-SPINE

REBSTOCK®
Precision made in Germany

Mikro-Neurochirurgische Instrumente
Micro-Neurosurgical Instruments

 1/1
06-13-120
 190 mm
 7½"

	Artikel-Nr. Cat. No.	Gesamtlänge Total length
	1/1 06-13-120	190 mm / 7½"
	06-13-122	210 mm / 8¼"
	06-13-124	240 mm / 9½"
	06-13-159	255 mm / 10"
	gerade straight	
	1/1 06-13-130	190 mm / 7½"
	06-13-132	210 mm / 8¼"
	06-13-134	240 mm / 9½"
	06-63-136	255 mm / 10"
	gerade straight	
	1/1 06-13-140	190 mm / 7½"
	06-13-142	210 mm / 8¼"
	06-13-144	240 mm / 9½"
	06-13-160	255 mm / 10"
	gerade straight	
	1/1 06-13-121	190 mm / 7½"
	06-13-123	210 mm / 8¼"
	06-13-125	240 mm / 9½"
	06-13-161	255 mm / 10"
	aufwärts gebogen curved up	
	1/1 06-13-131	190 mm / 7½"
	06-13-133	210 mm / 8¼"
	06-13-135	240 mm / 9½"
	06-63-137	255 mm / 10"
	aufwärts gebogen curved up	
	1/1 06-13-141	190 mm / 7½"
	06-13-143	210 mm / 8¼"
	06-13-145	240 mm / 9½"
	06-13-162	255 mm / 10"
	aufwärts gebogen curved up	

Standard Line

 Oberfläche matt gebürstet
 Surface polished





 Beispiel-Artikel-Nr.
 Example Cat. No.

06-13-120
Black Line

 Oberfläche schwarz, titanbeschichtet
 Surface black, titanium-coated

 Beispiel-Artikel-Nr.
 Example Cat. No.

06-13-120B

Artikel-Nr. Cat. No.	Gesamtlänge Total length	
06-13-163 abwärts gebogen <i>curved up curved down</i>	210 mm / 8¼"	1/1 
06-13-164 abwärts gebogen <i>curved down</i>	210 mm / 8¼"	1/1 
06-13-167 mit Knopf, seitwärts gewinkelt <i>with probe, angled to the side</i>	210 mm / 8¼"	1/1 45° 
06-13-168 seitwärts gewinkelt <i>angled to the side</i>	210 mm / 8¼"	1/1 45° 
06-13-169 seitwärts gewinkelt <i>angled to the side</i>	210 mm / 8¼"	1/1 125° 



Standard Line	Black Line
Oberfläche matt gebürstet <i>Surface polished</i>	Oberfläche schwarz, titanbeschichtet <i>Surface black, titanium-coated</i>
Beispiel-Artikel-Nr. Example Cat. No. 06-13-168	Beispiel-Artikel-Nr. Example Cat. No. 06-13-168B

1/1
06-13-168
 210 mm
 8¼"

 1/1
YASARGIL
06-04-035
 200 mm
 8"

		TITAN		
		Artikel-Nr. Cat. No.	Artikel-Nr. Cat. No.	Gesamtlänge Total length
1/1	YASARGIL	06-04-118	06-04-118T	145 mm / 5¾"
		06-04-030	06-04-030T	165 mm / 6½"
		06-04-034	06-04-034T	200 mm / 8"
				gerade <i>straight</i>
1/1	YASARGIL	06-04-031	06-04-031T	165 mm / 6½"
		06-04-035	06-04-035T	200 mm / 8"
				aufwärts gebogen <i>curved up</i>
1/1	YASARGIL	06-04-119	06-04-119T	145 mm / 5¾"
		06-04-036	06-04-036T	200 mm / 8"
				abwärts gebogen <i>curved down</i>
1/1	YASARGIL	06-04-073	06-04-073T	165 mm / 6½"
		06-04-075	06-04-075T	185 mm / 7½"
		06-04-032	06-04-032T	200 mm / 8"
				Präparierschere, gerade <i>dissecting scissors, straight</i>
1/1	YASARGIL	06-04-033	06-04-033T	200 mm / 8"
				Präparierschere, aufwärts gebogen <i>dissecting scissors, curved up</i>

Standard Line















 Oberfläche matt gebürstet
Surface polished

 Beispiel-Artikel-Nr.
Example Cat. No.
06-04-035
Black Line

 Oberfläche schwarz, titanbeschichtet
Surface black, titanium-coated

 Beispiel-Artikel-Nr.
Example Cat. No.
06-04-035B

TITAN

Artikel-Nr. Cat. No.	Artikel-Nr. Cat. No.	Gesamtlänge Total length		
06-04-038	06-04-038T	225 mm / 9"	YASARGIL	1/1
06-04-060	06-04-060T	225 mm / 9" Schneiden gezahnt, gerade <i>serrated blades, straight</i>		
06-54-062		245 mm / 9¾"		
06-04-039	06-04-039T	225 mm / 9"	YASARGIL	1/1
06-04-061		245 mm / 9¾" aufwärts gebogen <i>curved up</i>		
				
06-04-047	06-04-047T	225 mm / 9" abwärts gebogen <i>curved down</i>	YASARGIL	1/1
				
				
06-04-037	06-04-037T	225 mm / 9" gerade <i>straight</i>	VANNAS	1/1
				
				
06-04-040	06-04-040T	225 mm / 9" aufwärts gebogen <i>curved up</i>	VANNAS	1/1
				
				
06-04-044	06-04-044T	225 mm / 9" Präparierschere, gerade <i>dissecting scissors, straight</i>	YASARGIL	1/1
				
				
06-04-043	06-04-043T	225 mm / 9" Präparierschere, aufwärts gebogen <i>dissecting scissors, curved up</i>	YASARGIL	1/1
				
				



Standard Line	Black Line
Oberfläche matt gebürstet <i>Surface polished</i> Beispiel-Artikel-Nr. <i>Example Cat. No.</i> 06-04-039	Oberfläche schwarz, titanbeschichtet <i>Surface black, titanium-coated</i> Beispiel-Artikel-Nr. <i>Example Cat. No.</i> 06-04-039B

1/1
YASARGIL
06-04-039
 225 mm
 9"

 1/1
NAGEL
06-04-056
 200 mm
 8"

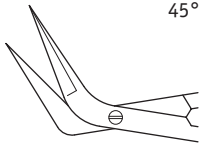
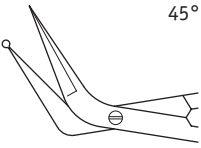
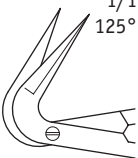
		Artikel-Nr. Cat. No.	Gesamtlänge Total length
 1/1 45°	NAGEL	06-04-056	200 mm / 8" seitwärts gewinkelt <i>angled to the side</i>
 1/1 45°		06-04-057	200 mm / 8" mit Knopf, seitwärts gewinkelt <i>with probe, angled to the side</i>
 1/1 125°		06-04-059	190 mm / 7½" seitwärts gewinkelt <i>angled to the side</i>





Standard Line

 Oberfläche matt gebürstet
Surface polished

 Beispiel-Artikel-Nr.
Example Cat. No.
06-04-056
Black Line

 Oberfläche schwarz, titanbeschichtet
Surface black, titanium-coated

 Beispiel-Artikel-Nr.
Example Cat. No.
06-04-056B

Artikel-Nr. Cat. No.	Gesamtlänge Total length		
06-04-105	190 mm / 7½"		1/1 
06-04-106	190 mm / 7½"		1/1 
06-04-107	190 mm / 7½"	VANNAS	1/1 
06-04-108	190 mm / 7½"	VANNAS	1/1 
06-04-120	195 mm / 7¾"		1/1 



Standard Line	Black Line
Oberfläche matt gebürstet <i>Surface polished</i>	Oberfläche schwarz, titanbeschichtet <i>Surface black, titanium-coated</i>
Beispiel-Artikel-Nr. Example Cat. No. 06-04-108	Beispiel-Artikel-Nr. Example Cat. No. 06-04-108B

1/1
06-04-108
 190 mm
 7½"

 1/1
06-13-010
 120 mm
 4¾"

		Artikel-Nr. Cat. No.	Gesamtlänge Total length
1/1		06-13-010 06-63-010	120 mm / 4¾" 145 mm / 5¾" gerade straight
1/1		06-13-011 06-63-011	120 mm / 4¾" 145 mm / 5¾" gebogen curved
1/1		06-13-012 06-63-012	120 mm / 4¾" 145 mm / 5¾" gebogen curved
1/1		06-13-013 06-63-013	120 mm / 4¾" 145 mm / 5¾" gebogen curved
1/1		06-13-014 06-63-014	120 mm / 4¾" 145 mm / 5¾" mit Knopf, gebogen with probe, curved



Standard Line

 Oberfläche matt gebürstet
 Surface polished

 Beispiel-Artikel-Nr.
 Example Cat. No. **06-13-010**
Black Line

 Oberfläche schwarz, titanbeschichtet
 Surface black, titanium-coated

 Beispiel-Artikel-Nr.
 Example Cat. No. **06-13-010B**

Artikel-Nr. Cat. No.		Gesamtlänge Total length	
06-13-040	gerade straight	170 mm / 6¾"	1/1 
06-13-041	gebogen curved	170 mm / 6¾"	1/1 



1/1
 06-13-040
 170 mm
 6¾"

Standard Line	Black Line
Oberfläche matt gebürstet Surface polished Beispiel-Artikel-Nr. Example Cat. No. 06-13-040	Oberfläche schwarz, titanbeschichtet Surface black, titanium-coated Beispiel-Artikel-Nr. Example Cat. No. 06-13-040B

 1/1
06-04-019
 160 mm
 6¼"

		Artikel-Nr. Cat. No.	Gesamtlänge Total length
1/1		06-04-012	120 mm / 4¾"
		06-04-016	160 mm / 6¼"
		06-04-020	160 mm / 6¼" Schneiden gezahnt <i>serrated blades</i>
		06-04-022	185 mm / 7¼"
	gerade <i>straight</i>		
1/1		06-04-013	120 mm / 4¾"
		06-04-017	160 mm / 6¼"
		06-04-021	160 mm / 6¼" Schneiden gezahnt <i>serrated blades</i>
		06-04-023	185 mm / 7¼"
	gebogen <i>curved</i>		
1/1		06-04-014	120 mm / 4¾"
		06-04-018	160 mm / 6¼"
	gerade <i>straight</i>		
1/1		06-04-015	120 mm / 4¾"
		06-04-019	160 mm / 6¼"
	gebogen <i>curved</i>		
1/1		06-04-025	185 mm / 7¼" Präparierschere, gerade <i>dissecting scissors, straight</i>
1/1		06-04-028	130 mm / 5⅞" Venenschere <i>vein scissors</i>
1/1		06-04-011	120 mm / 4¾" gewinkelt <i>angled</i>
1/1 45°		06-04-024	185 mm / 7¼" seitwärts gebogen <i>curved to the side</i>











Standard Line

 Oberfläche matt gebürstet
Surface polished

 Beispiel-Artikel-Nr.
Example Cat. No.
06-04-019
Black Line

 Oberfläche schwarz, titanbeschichtet
Surface black, titanium-coated

 Beispiel-Artikel-Nr.
Example Cat. No.
06-04-019B

Artikel-Nr. Cat. No.	Gesamtlänge Total length		
06-54-012	120 mm / 4¾"		1/1
06-54-016	160 mm / 6¼"		
06-54-020	160 mm / 6¼" Schneiden gezahnt <i>serrated blades</i>	MILLESI	
06-54-022	185 mm / 7¼"	YASARGIL	
	gerade <i>straight</i>		
06-54-013	120 mm / 4¾"		1/1
06-54-017	160 mm / 6¼"		
06-54-021	160 mm / 6¼" Schneiden gezahnt <i>serrated blades</i>	MILLESI	
06-54-023	185 mm / 7¼"	JACOBSON	
	gebogen <i>curved</i>		
06-54-014	120 mm / 4¾"	VANNAS	1/1
06-54-018	160 mm / 6¼"		
	gerade <i>straight</i>		
06-54-015	120 mm / 4¾"	VANNAS	1/1
06-54-019	160 mm / 6¼"		
	gebogen <i>curved</i>		
06-54-025	185 mm / 7¼"		1/1
	Präparierschere, gerade <i>dissecting scissors, straight</i>		
06-54-028	130 mm / 5½"	BIEMER	1/1
	Venenschere <i>vein scissors</i>		
06-54-011	120 mm / 4¾"	VANNAS	1/1
	gewinkelt <i>angled</i>		
06-54-024	185 mm / 7¼"	POTTS-YASARGIL	1/1 45°
	seitwärts gebogen <i>curved to the side</i>		



1/1
06-54-016
160 mm
6¼"

Standard Line	Black Line
Oberfläche matt gebürstet <i>Surface polished</i> Beispiel-Artikel-Nr. <i>Example Cat. No.</i> 06-54-016	Oberfläche schwarz, titanbeschichtet <i>Surface black, titanium-coated</i> Beispiel-Artikel-Nr. <i>Example Cat. No.</i> 06-54-016B

 1/1
06-13-433
 170 mm
 6¾"

kurzes Blatt short blade	Artikel-Nr. Cat. No.	Gesamtlänge Total length
1/1 25° 	06-13-431	170 mm / 6¾" seitwärts gewinkelt angled to the side
1/1 45° 	06-13-432	170 mm / 6¾" seitwärts gewinkelt angled to the side
1/1 60° 	06-13-433	170 mm / 6¾" seitwärts gewinkelt angled to the side
1/1 90° 	06-13-434	165 mm / 6½" seitwärts gewinkelt angled to the side
1/1 125° 	06-13-435	165 mm / 6½" seitwärts gewinkelt angled to the side
1/1 	06-13-444	165 mm / 6½" gerade straight
1/1 	06-13-430	165 mm / 6½" gebogen curved

Standard Line

 Oberfläche matt gebürstet
 Surface polished

 Beispiel-Artikel-Nr.
 Example Cat. No. **06-13-433**
Black Line

 Oberfläche schwarz, titanbeschichtet
 Surface black, titanium-coated

 Beispiel-Artikel-Nr.
 Example Cat. No. **06-13-433B**

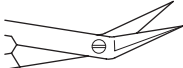
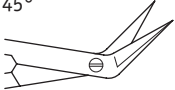
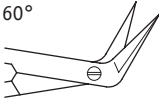
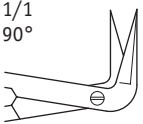
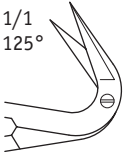
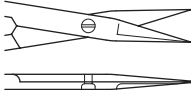
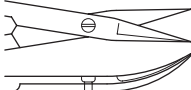

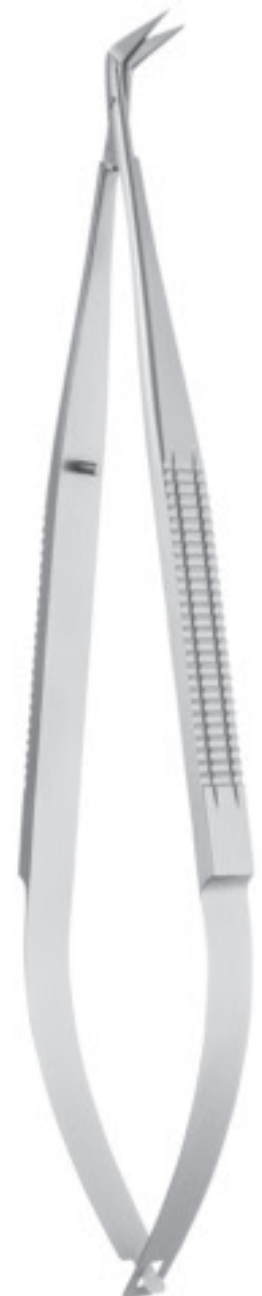

Artikel-Nr. Cat. No.	Gesamtlänge Total length	mittellanges Blatt medium blade
06-13-437 seitwärts gewinkelt <i>angled to the side</i>	170 mm / 6¾"	1/1 25° 
06-13-438 seitwärts gewinkelt <i>angled to the side</i>	170 mm / 6¾"	1/1 45° 
06-13-439 seitwärts gewinkelt <i>angled to the side</i>	170 mm / 6¾"	1/1 60° 
06-13-440 seitwärts gewinkelt <i>angled to the side</i>	165 mm / 6½"	1/1 90° 
06-13-441 seitwärts gewinkelt <i>angled to the side</i>	165 mm / 6½"	1/1 125° 
06-13-442 gerade <i>straight</i>	165 mm / 6½"	1/1 
06-13-436 gebogen <i>curved</i>	165 mm / 6½"	1/1 

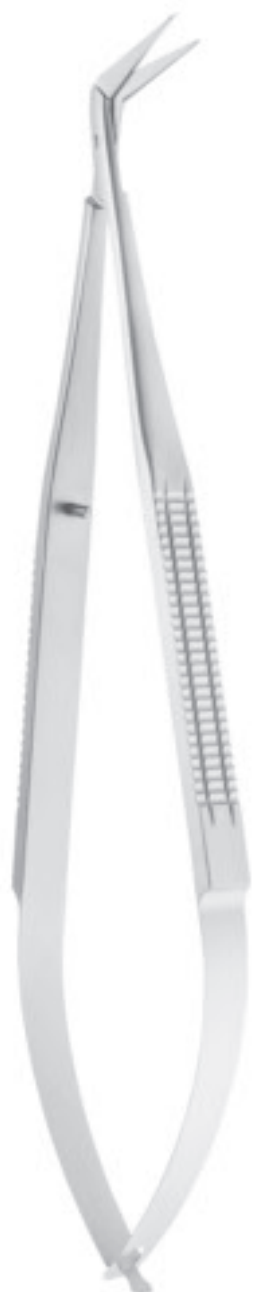

1/1
06-13-439
170 mm
6¾"

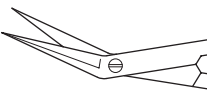
Standard Line	Black Line
Oberfläche matt gebürstet <i>Surface polished</i>	Oberfläche schwarz, titanbeschichtet <i>Surface black, titanium-coated</i>
Beispiel-Artikel-Nr. Example Cat. No. 06-13-439	Beispiel-Artikel-Nr. Example Cat. No. 06-13-439B

 1/1
06-13-472
 170 mm
 6¾"

langes Blatt long blade	Artikel-Nr. Cat. No.	Gesamtlänge Total length
1/1 25° 	06-13-470	170 mm / 6¾" seitwärts gewinkelt angled to the side
1/1 45° 	06-13-471	170 mm / 6¾" seitwärts gewinkelt angled to the side
1/1 60° 	06-13-472	170 mm / 6¾" seitwärts gewinkelt angled to the side
1/1 90° 	06-13-473	165 mm / 6½" seitwärts gewinkelt angled to the side
1/1 125° 	06-13-474	165 mm / 6½" seitwärts gewinkelt angled to the side





Standard Line

 Oberfläche matt gebürstet
 Surface polished

 Beispiel-Artikel-Nr.
 Example Cat. No. **06-13-472**
Black Line

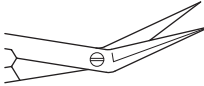
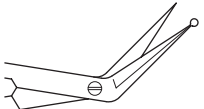
 Oberfläche schwarz, titanbeschichtet
 Surface black, titanium-coated

 Beispiel-Artikel-Nr.
 Example Cat. No. **06-13-472B**





Artikel-Nr. Cat. No.	Gesamtlänge Total length	langes Blatt long blade
06-13-451 mit Knopf, seitwärts gewinkelt with probe, angled to the side	170 mm / 6¾"	1/1 25° 
06-13-452 mit Knopf, seitwärts gewinkelt with probe, angled to the side	170 mm / 6¾"	1/1 45° 
06-13-453 mit Knopf, seitwärts gewinkelt with probe, angled to the side	170 mm / 6¾"	1/1 60° 
06-13-454 mit Knopf, seitwärts gewinkelt with probe, angled to the side	165 mm / 6½"	1/1 90° 
06-13-455 mit Knopf, seitwärts gewinkelt with probe, angled to the side	165 mm / 6½"	1/1 125° 

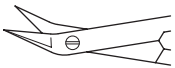

1/1
06-13-451
170 mm
6¾"

Standard Line	Black Line
Oberfläche matt gebürstet <i>Surface polished</i>	Oberfläche schwarz, titanbeschichtet <i>Surface black, titanium-coated</i>
Beispiel-Artikel-Nr. Example Cat. No. 06-13-451	Beispiel-Artikel-Nr. Example Cat. No. 06-13-451B

 1/1
06-13-506
 170 mm
 6¾"

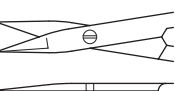
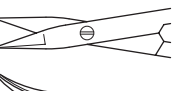
kurzes Blatt short blade	Artikel-Nr. Cat. No.	Gesamtlänge Total length
1/1 25° 	06-13-504	170 mm / 6¾" seitwärts gewinkelt angled to the side
1/1 45° 	06-13-505	170 mm / 6¾" seitwärts gewinkelt angled to the side
1/1 60° 	06-13-506	170 mm / 6¾" seitwärts gewinkelt angled to the side
1/1 90° 	06-13-507	170 mm / 6¾" seitwärts gewinkelt angled to the side
1/1 125° 	06-13-508	170 mm / 6¾" seitwärts gewinkelt angled to the side
1/1 	06-63-502	175 mm / 7" gerade straight
1/1 	06-13-503	175 mm / 7" gebogen curved

Standard Line

 Oberfläche matt gebürstet
 Surface polished



 Beispiel-Artikel-Nr.
 Example Cat. No.

06-13-506
Black Line

 Oberfläche schwarz, titanbeschichtet
 Surface black, titanium-coated

 Beispiel-Artikel-Nr.
 Example Cat. No.

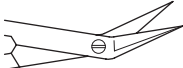
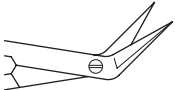
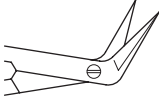
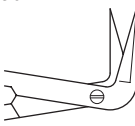
06-13-506B

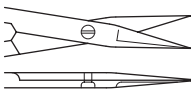
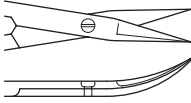



Artikel-Nr. Cat. No.	Gesamtlänge Total length	mittellanges Blatt medium blade
06-13-482	170 mm / 6¾"	1/1 25° 
06-13-483	170 mm / 6¾"	1/1 45° 
06-13-484	170 mm / 6¾"	1/1 60° 
06-13-485	170 mm / 6¾"	1/1 90° 
06-13-486	170 mm / 6¾"	1/1 125° 
06-13-488	175 mm / 7"	1/1 
06-13-481	175 mm / 7"	1/1 

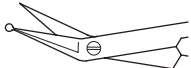

1/1
06-13-484
170 mm
6¾"

Standard Line	Black Line
Oberfläche matt gebürstet <i>Surface polished</i>	Oberfläche schwarz, titanbeschichtet <i>Surface black, titanium-coated</i>
Beispiel-Artikel-Nr. Example Cat. No. 06-13-484	Beispiel-Artikel-Nr. Example Cat. No. 06-13-484B

 1/1
06-13-491
 170 mm
 6¾"

mittellanges Blatt <i>medium blade</i>	Artikel-Nr. <i>Cat. No.</i>	Gesamtlänge <i>Total length</i>
1/1 25° 	06-13-489	170 mm / 6¾" mit Knopf, seitwärts gewinkelt <i>with probe, angled to the side</i>
1/1 45° 	06-13-490	170 mm / 6¾" mit Knopf, seitwärts gewinkelt <i>with probe, angled to the side</i>
1/1 60° 	06-13-491	170 mm / 6¾" mit Knopf, seitwärts gewinkelt <i>with probe, angled to the side</i>
1/1 90° 	06-13-492	165 mm / 6½" mit Knopf, seitwärts gewinkelt <i>with probe, angled to the side</i>
1/1 125° 	06-13-493	165 mm / 6½" mit Knopf, seitwärts gewinkelt <i>with probe, angled to the side</i>



Standard Line

 Oberfläche matt gebürstet
Surface polished

 Beispiel-Artikel-Nr.
Example Cat. No. **06-13-491**
Black Line

 Oberfläche schwarz, titanbeschichtet
Surface black, titanium-coated

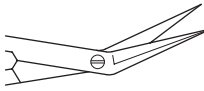
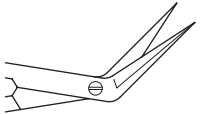
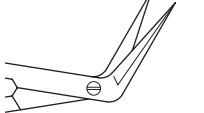
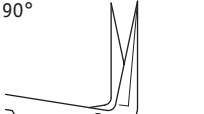
 Beispiel-Artikel-Nr.
Example Cat. No. **06-13-491B**



Artikel-Nr. Cat. No.	Gesamtlänge Total length	langes Blatt long blade
06-13-476	170 mm / 6¾"	1/1 25° 
06-13-477	170 mm / 6¾"	1/1 45° 
06-13-478	170 mm / 6¾"	1/1 60° 
06-13-479	170 mm / 6¾"	1/1 90° 
06-13-480	170 mm / 6¾"	1/1 125° 



1/1
06-13-478
170 mm
6¾"

Standard Line	Black Line
Oberfläche matt gebürstet <i>Surface polished</i>	Oberfläche schwarz, titanbeschichtet <i>Surface black, titanium-coated</i>
Beispiel-Artikel-Nr. Example Cat. No. 06-13-478	Beispiel-Artikel-Nr. Example Cat. No. 06-13-478B

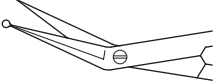
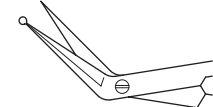
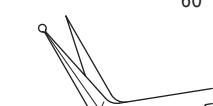
 1/1
06-54-127
 175 mm
 7"

langes Blatt long blade	Artikel-Nr. Cat. No.	Gesamtlänge Total length
1/1 25° 	06-54-125	180 mm / 7" mit Knopf, seitwärts gewinkelt with probe, angled to the side
1/1 45° 	06-54-126	180 mm / 7" mit Knopf, seitwärts gewinkelt with probe, angled to the side
1/1 60° 	06-54-127	175 mm / 7" mit Knopf, seitwärts gewinkelt with probe, angled to the side
1/1 90° 	06-54-128	165 mm / 6½" mit Knopf, seitwärts gewinkelt with probe, angled to the side
1/1 125° 	06-54-129	165 mm / 6½" mit Knopf, seitwärts gewinkelt with probe, angled to the side

Standard Line

 Oberfläche matt gebürstet
 Surface polished

 Beispiel-Artikel-Nr.
 Example Cat. No. **06-54-127**
Black Line

 Oberfläche schwarz, titanbeschichtet
 Surface black, titanium-coated

 Beispiel-Artikel-Nr.
 Example Cat. No. **06-54-127B**

TITAN

Artikel-Nr. Cat. No.	Artikel-Nr. Cat. No.	Gesamtlänge Total length		
06-04-100	06-04-100T	145 mm / 5¾"		1/1
06-04-600	06-04-600T	180 mm / 7"	gerade straight	
06-04-101	06-04-101T	145 mm / 5¾"		1/1
06-04-601	06-04-601T	180 mm / 7"	gebogen curved	
06-54-115	06-54-115T	145 mm / 5¾"	VANNAS	1/1
06-54-116	06-54-116T	180 mm / 7"		
06-04-117	06-04-117T	230 mm / 9"		gerade straight
06-04-103	06-04-103T	145 mm / 5¾"		1/1
06-04-603	06-04-603T	180 mm / 7"	Präparierschere, gebogen dissecting scissors, curved	



1/1
06-04-100
145 mm
5¾"

Standard Line	Black Line
Oberfläche matt gebürstet <i>Surface polished</i>	Oberfläche schwarz, titanbeschichtet <i>Surface black, titanium-coated</i>
Beispiel-Artikel-Nr. Example Cat. No. 06-04-100	Beispiel-Artikel-Nr. Example Cat. No. 06-04-100B



	Artikel-Nr. Cat. No.	Gesamtlänge Total length
1/1	06-13-170	200 mm / 7¾"
	06-13-173	220 mm / 8½"
	06-13-175	240 mm / 9¾"
		aufwärts gebogen curved up

Standard Line

 Oberfläche matt gebürstet
Surface polished

 Beispiel-Artikel-Nr.
 Example Cat. No.

06-13-170
Black Line

 Oberfläche schwarz, titanbeschichtet
Surface black, titanium-coated

 Beispiel-Artikel-Nr.
 Example Cat. No.

06-13-170B
 **Diamond Line**

 Maul diamantbeschichtet
Jaw diamond dust coated

 Beispiel-Artikel-Nr.
 Example Cat. No.

06-13-170D

 1/1
06-13-170
 200 mm
 7¾"

TITAN

Artikel-Nr. Cat. No.	Artikel-Nr. Cat. No.	Gesamtlänge Total length		
06-54-089	06-54-089T	165 mm / 6½"	YASARGIL	1/1
06-04-092	06-04-092T	200 mm / 8"		
06-04-096	06-04-096T	225 mm / 9"		
06-54-099		245 mm / 9¾"		
		gerade straight		
06-04-089	06-04-089T	165 mm / 6½"	YASARGIL	1/1
06-04-093	06-04-093T	200 mm / 8"		
06-04-097	06-04-097T	225 mm / 9"		
06-04-099		245 mm / 9¾"		
		aufwärts gebogen curved up		



Standard Line	Black Line	Diamond Line
Oberfläche matt gebürstet Surface polished Beispiel-Artikel-Nr. Example Cat. No. 06-04-092	Oberfläche schwarz, titanbeschichtet Surface black, titanium-coated Beispiel-Artikel-Nr. Example Cat. No. 06-04-092B	Maul diamantbeschichtet Jaw diamond dust coated Beispiel-Artikel-Nr. Example Cat. No. 06-04-092D



1/1
YASARGIL
06-04-092
 200 mm
 8"



		Artikel-Nr. Cat. No.	Gesamtlänge Total length
1/1		06-63-021	145 mm / 5¾" ohne Sperre, gebogen <i>without ratchet, curved</i>
1/1		06-13-021	145 mm / 5¾" mit Sperre, gebogen <i>with ratchet, curved</i>

1/1
06-13-021
145 mm
5¾"

Standard Line	Black Line	Diamond Line
Oberfläche matt gebürstet <i>Surface polished</i> Beispiel-Artikel-Nr. <i>Example Cat. No.</i> 06-13-021	Oberfläche schwarz, titanbeschichtet <i>Surface black, titanium-coated</i> Beispiel-Artikel-Nr. <i>Example Cat. No.</i> 06-13-021B	Maul diamantbeschichtet <i>Jaw diamond dust coated</i> Beispiel-Artikel-Nr. <i>Example Cat. No.</i> 06-13-021D



Artikel-Nr. Cat. No.	Gesamtlänge Total length		
06-63-061	180 mm / 7" ohne Sperre, gebogen without ratchet, curved		1/1 
06-13-061	180 mm / 7" mit Sperre, gebogen with ratchet, curved		1/1 



1/1
06-13-061
 180 mm
 7"



Standard Line	Black Line	 Diamond Line
Oberfläche matt gebürstet Surface polished	Oberfläche schwarz, titanbeschichtet Surface black, titanium-coated	Maul diamantbeschichtet Jaw diamond dust coated
Beispiel-Artikel-Nr. Example Cat. No. 06-13-061	Beispiel-Artikel-Nr. Example Cat. No. 06-13-061B	Beispiel-Artikel-Nr. Example Cat. No. 06-13-061D



	Artikel-Nr. Cat. No.	Gesamtlänge Total length
1/1	06-04-076	160 mm / 6¼"
	06-04-080	185 mm / 7¼"
		ohne Sperre, gerade without ratchet, straight
1/1	06-04-079	160 mm / 6¼"
	06-04-081	185 mm / 7¼"
		ohne Sperre, gebogen without ratchet, curved

1/1
06-04-076
 160 mm
 6¼"

Standard Line	Black Line	 Diamond Line
Oberfläche matt gebürstet Surface polished Beispiel-Artikel-Nr. <i>Example Cat. No.</i> 06-04-076	Oberfläche schwarz, titanbeschichtet Surface black, titanium-coated Beispiel-Artikel-Nr. <i>Example Cat. No.</i> 06-04-076B	Maul diamantbeschichtet Jaw diamond dust coated Beispiel-Artikel-Nr. <i>Example Cat. No.</i> 06-04-076D





Artikel-Nr. Cat. No.	Gesamtlänge Total length	
06-54-076	160 mm / 6¼"	1/1
06-54-080	185 mm / 7¼"	
	ohne Sperre, gerade without ratchet, straight	
06-54-079	160 mm / 6¼"	1/1
06-54-081	185 mm / 7¼"	
	ohne Sperre, gebogen without ratchet, curved	







1/1
06-54-079
160 mm
6¼"

Standard Line	Black Line	 Diamond Line
Oberfläche matt gebürstet <i>Surface polished</i>	Oberfläche schwarz, titanbeschichtet <i>Surface black, titanium-coated</i>	Maul diamantbeschichtet <i>Jaw diamond dust coated</i>
Beispiel-Artikel-Nr. Example Cat. No. 06-54-079	Beispiel-Artikel-Nr. Example Cat. No. 06-54-079B	Beispiel-Artikel-Nr. Example Cat. No. 06-54-079D

 1/1
JACOBSON
06-54-117
 180 mm
 7"



		TC		
		Artikel-Nr. Cat. No.	Artikel-Nr. Cat. No.	Gesamtlänge Total length
1/1	CASTROVIEJO JACOBSON 	06-54-200	06-54-210	145 mm / 5¾"
		06-04-045	06-54-212	180 mm / 7"
		06-54-202	06-54-214	210 mm / 8¼"
		06-54-204	06-54-216	230 mm / 9"
		mit glatten TC-Einlagen with smooth TC inserts		ohne Sperre, gerade without ratchet, straight
1/1	CASTROVIEJO JACOBSON 	06-54-201	06-54-211	145 mm / 5¾"
		06-54-045	06-54-213	180 mm / 7"
		06-54-203	06-54-215	210 mm / 8¼"
		06-54-205	06-54-217	230 mm / 9"
		mit glatten TC-Einlagen with smooth TC inserts		ohne Sperre, gebogen without ratchet, curved
1/1	CASTROVIEJO JACOBSON 		06-54-218	145 mm / 5¾"
			06-54-117	180 mm / 7"
			06-54-220	210 mm / 8¼"
			06-54-222	230 mm / 9"
		mit gerieften TC-Einlagen with serrated TC inserts		ohne Sperre, gerade without ratchet, straight
1/1	CASTROVIEJO JACOBSON 		06-54-219	145 mm / 5¾"
			06-54-118	180 mm / 7"
			06-54-221	210 mm / 8¼"
			06-54-223	230 mm / 9"
		mit gerieften TC-Einlagen with serrated TC inserts		ohne Sperre, gebogen without ratchet, curved

		TC			
Artikel-Nr. Cat. No.	Artikel-Nr. Cat. No.	Gesamtlänge Total length			
02-13-563	02-13-001	145 mm / 5¾"	CASTROVIEJO	1/1	
06-04-046	06-54-224	180 mm / 7"	JACOBSON		
06-54-206	06-54-226	210 mm / 8¼"			
06-54-208	06-54-228	230 mm / 9"			
	mit glatten TC-Einlagen with smooth TC inserts	mit Sperre, gerade with ratchet, straight			
02-13-564	02-63-001	145 mm / 5¾"	CASTROVIEJO	1/1	
06-54-046	06-54-225	180 mm / 7"	JACOBSON		
06-54-207	06-54-227	210 mm / 8¼"			
06-54-209	06-54-229	230 mm / 9"			
	mit glatten TC-Einlagen with smooth TC inserts	mit Sperre, gebogen with ratchet, curved			
	02-13-002	145 mm / 5¾"	CASTROVIEJO	1/1	
	02-13-004	180 mm / 7"	JACOBSON		
	02-13-005	210 mm / 8¼"			
	02-63-230	230 mm / 9"			
	mit gerieften TC-Einlagen with serrated TC inserts	mit Sperre, gerade with ratchet, straight			
	02-63-002	145 mm / 5¾"	CASTROVIEJO	1/1	
	02-63-004	180 mm / 7"	JACOBSON		
	02-63-005	210 mm / 8¼"			
	02-63-231	230 mm / 9"			
	mit gerieften TC-Einlagen with serrated TC inserts	mit Sperre, gebogen with ratchet, curved			



1/1
JACOBSON
02-13-004
180 mm
7"

TITAN

		Artikel-Nr. Cat. No.	Artikel-Nr. Cat. No.	Gesamtlänge Total length
1/1	BARRAQUER 	06-04-230		120 mm / 4¾"
		06-04-240	06-04-240T	150 mm / 6"
		06-04-244	06-04-244T	180 mm / 7"
		06-54-248	06-54-248T	210 mm / 8¼"
		06-54-252		230 mm / 9"
				ohne Sperre, gerade without ratchet, straight
1/1	BARRAQUER 	06-04-231		120 mm / 4¾"
				ohne Sperre, gebogen without ratchet, curved
1/1	REILL 	06-04-241	06-04-241T	150 mm / 6"
		06-04-245	06-04-245T	180 mm / 7"
		06-54-251	06-54-251T	210 mm / 8¼"
		06-54-255		230 mm / 9"
				ohne Sperre, gebogen without ratchet, curved

1/1
REILL
06-04-241
 150 mm
 6"

Standard Line

Oberfläche matt gebürstet
 Surface polished

Beispiel-Artikel-Nr.
 Example Cat. No.

06-04-241

Black Line

Oberfläche schwarz, titanbeschichtet
 Surface black, titanium-coated

Beispiel-Artikel-Nr.
 Example Cat. No.

06-04-241B



 **Diamond Line**

Maul diamantbeschichtet
 Jaw diamond dust coated

Beispiel-Artikel-Nr.
 Example Cat. No.

06-04-241D

TITAN



Artikel-Nr. Cat. No.	Artikel-Nr. Cat. No.	Gesamtlänge Total length		
06-04-232		120 mm / 4¾"	BARRAQUER	1/1
06-04-242	06-04-242T	150 mm / 6"		
06-04-246	06-04-246T	180 mm / 7"		
06-54-250	06-54-250T	210 mm / 8¼"		
06-54-254		230 mm / 9"		
		mit Sperre, gerade with ratchet, straight		
06-04-233		120 mm / 4¾"	BARRAQUER	1/1
		mit Sperre, gebogen with ratchet, curved		
06-04-243	06-04-243T	150 mm / 6"		
06-04-247	06-04-247T	180 mm / 7"		
06-54-253	06-54-253T	210 mm / 8¼"		
06-04-249		230 mm / 9"		
		mit Sperre, gebogen with ratchet, curved		



1/1
06-04-243
150 mm
6"

Standard Line	Black Line	Diamond Line
<p>Oberfläche matt gebürstet <i>Surface polished</i></p> <p>Beispiel-Artikel-Nr. Example Cat. No. 06-04-243</p>	<p>Oberfläche schwarz, titanbeschichtet <i>Surface black, titanium-coated</i></p> <p>Beispiel-Artikel-Nr. Example Cat. No. 06-04-243B</p>	<p>Maul diamantbeschichtet <i>Jaw diamond dust coated</i></p> <p>Beispiel-Artikel-Nr. Example Cat. No. 06-04-243D</p>

 1/1
06-13-524
 120 mm
 4¾"

		Artikel-Nr. Cat. No.	Gesamtlänge Total length
für Nahtmaterial 7/0-10/0 <i>for suture size</i> 7/0-10/0	1/1	06-13-524	120 mm / 4¾"
		06-13-525	160 mm / 6¼"
		06-13-526	185 mm / 7¼"
		06-13-527	210 mm / 8¼"
		06-13-532	230 mm / 9"
ohne Sperre, gerade <i>without ratchet, straight</i>			
diamantbeschichtet <i>diamond dust coated</i>			
für Nahtmaterial 5/0-8/0 <i>for suture size</i> 5/0-8/0	1/1	06-13-528	145 mm / 5¾"
		06-13-529	160 mm / 6¼"
		06-13-530	185 mm / 7¼"
		06-13-531	210 mm / 8¼"
		06-13-533	230 mm / 9"
ohne Sperre, gerade <i>without ratchet, straight</i>			
diamantbeschichtet <i>diamond dust coated</i>			





Artikel-Nr. Cat. No.	Gesamtlänge Total length	
06-13-520	120 mm / 4¾"	1/1
06-13-521	160 mm / 6¼"	
06-13-563	185 mm / 7¼"	
06-13-565	210 mm / 8¼"	
06-13-567	230 mm / 9"	
	mit Sperre, gerade <i>with ratchet, straight</i>	für Nahtmaterial 7/0 - 10/0
	diamantbeschichtet <i>diamond dust coated</i>	for suture size 7/0 - 10/0
06-13-522	145 mm / 5¾"	1/1
06-13-523	160 mm / 6¼"	
06-13-564	185 mm / 7¼"	
06-13-566	210 mm / 8¼"	
06-13-568	230 mm / 9"	
	mit Sperre, gerade <i>with ratchet, straight</i>	für Nahtmaterial 5/0 - 8/0
	diamantbeschichtet <i>diamond dust coated</i>	for suture size 5/0 - 8/0
06-13-218	185 mm / 7¼"	1/1
06-13-228	210 mm / 8¼"	
06-13-230	230 mm / 9"	
	mit Sperre, gerade <i>with ratchet, straight</i>	für Nahtmaterial 4/0 - 6/0
	diamantbeschichtet <i>diamond dust coated</i>	for suture size 4/0 - 6/0
06-13-221	210 mm / 8¼"	1/1
06-13-223	230 mm / 9"	
	mit Sperre, gebogen <i>with ratchet, curved</i>	für Nahtmaterial 4/0 - 6/0
	diamantbeschichtet <i>diamond dust coated</i>	for suture size 4/0 - 6/0





1/1
06-13-520
120 mm
4¾"



1/1
06-54-262
 180 mm
 7"

		TC		
		Artikel-Nr. Cat. No.	Gesamtlänge Total length	
1/1		06-54-260	150 mm / 6"	
		06-54-262	180 mm / 7"	
		06-54-264	210 mm / 8¼"	
		06-54-266	230 mm / 9"	
		mit gerieften TC-Einlagen with serrated TC inserts	ohne Sperre, gerade without ratchet, straight	
1/1		06-54-261	150 mm / 6"	
		06-54-263	180 mm / 7"	
		06-54-265	210 mm / 8¼"	
		06-54-267	230 mm / 9"	
		mit gerieften TC-Einlagen with serrated TC inserts	ohne Sperre, gebogen without ratchet, curved	

TC



Artikel-Nr. Cat. No.	Gesamtlänge Total length	
06-54-270	150 mm / 6"	1/1
06-54-272	180 mm / 7"	
06-54-274	210 mm / 8¼"	
06-54-276	230 mm / 9"	
mit gerieften TC-Einlagen with serrated TC inserts	mit Sperre, gerade with ratchet, straight	
06-54-271	150 mm / 6"	1/1
06-54-273	180 mm / 7"	
06-54-275	210 mm / 8¼"	
06-54-277	230 mm / 9"	
mit gerieften TC-Einlagen with serrated TC inserts	mit Sperre, gebogen with ratchet, curved	



1/1
06-54-272
180 mm
7"



TC

	Artikel-Nr. Cat. No.	Artikel-Nr. Cat. No.	Gesamtlänge Total length
1/1 		06-13-388 mit gerieften TC-Einlagen with serrated TC inserts	180 mm / 7" mit Sperre, gerade with ratchet, straight
1/1 		06-13-390 mit gerieften TC-Einlagen with serrated TC inserts	200 mm / 8" mit Sperre, gerade with ratchet, straight
1/1 	06-13-392		230 mm / 9" mit Sperre, gerade with ratchet, straight

	Artikel-Nr. Cat. No.	Artikel-Nr. Cat. No.	Gesamtlänge Total length
1/1 	06-13-398		200 mm / 8" ohne Sperre, gerade without ratchet, straight

1/1
06-13-392
 230 mm
 9"



Artikel-Nr. Cat. No.	Gesamtlänge Total length		
06-13-560	125 mm / 5"		1/1
06-13-561	180 mm / 7"		
	mit Sperre, gerade with ratchet, straight		A
	diamantbeschichtet diamond dust coated		



1/1
06-13-560
125 mm
5"



		Artikel-Nr. Cat. No.	Gesamtlänge Total length
1/1		06-13-150	190 mm / 7¾"
		06-13-153	210 mm / 8¼"
		06-13-156	240 mm / 9½"
Spitzen 0,5 mm, gerade tips 0.5 mm, straight			
1/1		06-13-151	190 mm / 7¾"
		06-13-154	210 mm / 8¼"
		06-13-157	240 mm / 9½"
Spitzen 0,9 mm, gerade tips 0.9 mm, straight			
1/1		06-13-174	210 mm / 8¼"
1 x 2 Zähne, gerade 1 x 2 teeth, straight			

1/1
06-13-150
 190 mm
 7¾"

Standard Line

Oberfläche matt gebürstet
Surface polished

Beispiel-Artikel-Nr.
 Example Cat. No.

06-13-150

Black Line

Oberfläche schwarz, titanbeschichtet
Surface black, titanium-coated

Beispiel-Artikel-Nr.
 Example Cat. No.

06-13-150B

Diamond Line

Maul diamantbeschichtet
Jaw diamond dust coated

Beispiel-Artikel-Nr.
 Example Cat. No.

06-13-150D

TITAN				
Artikel-Nr. Cat. No.	Artikel-Nr. Cat. No.	Gesamtlänge Total length		
02-04-830	02-04-830T	160 mm / 6¼"	YASARGIL	1/1
02-04-835	02-04-835T	180 mm / 7"		
02-04-840	02-04-840T	200 mm / 8"		
02-04-845	02-04-845T	220 mm / 8¾"		
02-04-850		240 mm / 9½"		
		Spitzen 0,6 mm, gerade tips 0.6 mm, straight		
02-04-831	02-04-831T	160 mm / 6¼"	YASARGIL	1/1
02-04-836	02-04-836T	180 mm / 7"		
02-04-841	02-04-841T	200 mm / 8"		
02-04-846	02-04-846T	220 mm / 8¾"		
02-04-851		240 mm / 9½"		
		Spitzen 0,9 mm, gerade tips 0.9 mm, straight		
02-04-837		180 mm / 7"	YASARGIL	1/1
02-54-838		200 mm / 8"		
02-54-839		220 mm / 8¾"		
02-54-840		240 mm / 9½"		
		1x2 Zähne, gerade 1x2 teeth, straight		



Standard Line	Black Line	Diamond Line
Oberfläche matt gebürstet <i>Surface polished</i> Beispiel-Artikel-Nr. <i>Example Cat. No.</i> 02-04-840	Oberfläche schwarz, titanbeschichtet <i>Surface black, titanium-coated</i> Beispiel-Artikel-Nr. <i>Example Cat. No.</i> 02-04-840B	Maul diamantbeschichtet <i>Jaw diamond dust coated</i> Beispiel-Artikel-Nr. <i>Example Cat. No.</i> 02-04-840D

1/1
YASARGIL
02-04-840
 200 mm
 8"

 1/2
06-04-110
 185 mm
 7¼"

	Artikel-Nr. Cat. No.	Gesamtlänge Total length
	1/1 06-04-110	185 mm / 7¼" Spitzen 0,3 mm, gerade tips 0.3 mm, straight
	1/1 06-04-111	185 mm / 7¼" Spitzen 0,6 mm, gerade tips 0.6 mm, straight
	1/1 06-04-112	185 mm / 7¼" Spitzen 0,6 mm, aufwärts gebogen tips 0.6 mm, angled up

 1/2
02-04-887
 160 mm
 6¼"

	Artikel-Nr. Cat. No.	Gesamtlänge Total length
	1/1 02-04-887	160 mm / 6¼" spitz, gerade pointed, straight
	1/1 02-04-888	160 mm / 6¼" 1 x 2 Zähne, gerade 1 x 2 teeth, straight

Standard Line

 Oberfläche matt gebürstet
 Surface polished

 Beispiel-Artikel-Nr.
 Example Cat. No. **06-04-110**
Black Line

 Oberfläche schwarz, titanbeschichtet
 Surface black, titanium-coated

 Beispiel-Artikel-Nr.
 Example Cat. No. **06-04-110B**
Diamond Line

 Maul diamantbeschichtet
 Jaw diamond dust coated

 Beispiel-Artikel-Nr.
 Example Cat. No. **06-04-110D**

Artikel-Nr. Cat. No.	Gesamtlänge Total length		
02-04-878	140 mm / 5½"	gerade straight	LUCAE 1/1
02-04-880	160 mm / 6¼"	gerade straight	JANSEN 1/1
02-04-870	175 mm / 7"	gerade straight	ADSON 1/1

1/2
JANSEN
02-04-880
160 mm
6¼"



TC	Artikel-Nr. Cat. No.	Gesamtlänge Total length		
	02-04-168	185 mm / 7¼"	gerade straight	GRUEN- WALD 1/1
	02-04-883	200 mm / 8"	gerade straight	GRUEN- WALD 1/1

1/2
GRUENWALD
02-04-168
185 mm
7¼"



Artikel-Nr. Cat. No.	Gesamtlänge Total length		
02-04-885	185 mm / 7¼"	spitz, gerade pointed, straight	1/1
02-04-879	140 mm / 5½"	1 x 2 Zähne, gerade 1 x 2 teeth, straight	LUCAE 1/1
02-04-886	200 mm / 8"	1 x 2 Zähne, gerade 1 x 2 teeth, straight	1/1

1/2
02-04-885
185 mm
7¼"





1/1
06-13-176
 210 mm
 8¼"

		Artikel-Nr. Cat. No.	Gesamtlänge Total length
2,5 mm		06-13-176	210 mm / 8¼"
		06-13-178	245 mm / 9¾"
			Maul flach gezahnt, gerade jaw flat toothed, straight
3,5 mm		06-13-177	210 mm / 8¼"
		06-13-179	245 mm / 9¾"
			Maul flach gezahnt, gerade jaw flat toothed, straight

Standard Line

Oberfläche matt gebürstet
 Surface polished

Beispiel-Artikel-Nr.
 Example Cat. No.

06-13-176
Black Line

Oberfläche schwarz, titanbeschichtet
 Surface black, titanium-coated

Beispiel-Artikel-Nr.
 Example Cat. No.

06-13-176B

Artikel-Nr. Cat. No.	Gesamtlänge Total length		
06-04-210	220 mm / 8¾"	YASARGIL	1/1 ø 3 mm
06-04-200	240 mm / 9½"	YASARGIL-SAMII	
Maul löffelförmig, gerade <i>jaw spoon-shaped, straight</i>			
06-04-212	220 mm / 8¾"	YASARGIL	1/1 ø 5 mm
06-04-202	240 mm / 9½"	YASARGIL-SAMII	
Maul löffelförmig, gerade <i>jaw spoon-shaped, straight</i>			
06-04-204	240 mm / 9½"	YASARGIL-SAMII	1/1 ø 7 mm
Maul löffelförmig, gerade <i>jaw spoon-shaped, straight</i>			
06-04-221	165 mm / 6½"	YASARGIL	1/1 ø 3 mm
06-04-223	200 mm / 8"		
06-04-214	220 mm / 8¾"		
Maul flach gezahnt, gerade <i>jaw flat toothed, straight</i>			
06-04-225	165 mm / 6½"	YASARGIL	1/1 ø 5 mm
06-04-229	200 mm / 8"		
06-04-216	220 mm / 8¾"		
Maul flach gezahnt, gerade <i>jaw flat toothed, straight</i>			
06-04-215	220 mm / 8¾"	HEIFETZ	1/1 ø 3 mm
Maul kürettenförmig gezahnt, gerade <i>urette jaw toothed, straight</i>			
06-04-217	220 mm / 8¾"	HEIFETZ	1/1 ø 5 mm
Maul kürettenförmig gezahnt, gerade <i>urette jaw toothed, straight</i>			











Standard Line	Black Line
Oberfläche matt gebürstet <i>Surface polished</i>	Oberfläche schwarz, titanbeschichtet <i>Surface black, titanium-coated</i>
Beispiel-Artikel-Nr. Example Cat. No. 06-04-216	Beispiel-Artikel-Nr. Example Cat. No. 06-04-216B

1/1
YASARGIL
06-04-216
 220 mm
 8¾"



1/1
SAMII
06-04-190
 230 mm
 9"

		Artikel-Nr. Cat. No.	Gesamtlänge Total length
	1/1 ø 3 mm SAMII	06-04-190	230 mm / 9" Maul löffelförmig, aufwärts gebogen <i>jaw spoon-shaped, angled up</i>
	1/1 ø 4 mm SAMII	06-04-191	230 mm / 9" Maul löffelförmig, aufwärts gebogen <i>jaw spoon-shaped, angled up</i>
	1/1 ø 5 mm SAMII	06-04-192	230 mm / 9" Maul löffelförmig, aufwärts gebogen <i>jaw spoon-shaped, angled up</i>
	1/1 ø 3 mm SAMII	06-04-195	230 mm / 9" Maul löffelförmig, abwärts gebogen <i>jaw spoon-shaped, angled down</i>
	1/1 ø 4 mm SAMII	06-04-196	230 mm / 9" Maul löffelförmig, abwärts gebogen <i>jaw spoon-shaped, angled down</i>
	1/1 ø 5 mm SAMII	06-04-197	230 mm / 9" Maul löffelförmig, abwärts gebogen <i>jaw spoon-shaped, angled down</i>
	1/1 ø 3 mm SAMII	06-04-218	220 mm / 8¾" Maul flach gezahnt, aufwärts gebogen <i>jaw flat serrated, angled up</i>
	1/1 ø 3 mm SAMII	06-04-219	220 mm / 8¾" Maul flach gezahnt, aufwärts gebogen <i>jaw flat serrated, angled up</i>

Standard Line

Oberfläche matt gebürstet
Surface polished

Beispiel-Artikel-Nr.
Example Cat. No.

06-04-190
Black Line

Oberfläche schwarz, titanbeschichtet
Surface black, titanium-coated

Beispiel-Artikel-Nr.
Example Cat. No.

06-04-190B





Artikel-Nr. Cat. No.	Gesamtlänge Total length		
06-04-234	220 mm / 8¾"	YASARGIL	1/1
	Maulbreite 3 mm jaw width 3 mm		
06-04-236	220 mm / 8¾"	YASARGIL	1/1
	Maulbreite 5 mm jaw width 5 mm		

Standard Line	Black Line
Oberfläche matt gebürstet <i>Surface polished</i>	Oberfläche schwarz, titanbeschichtet <i>Surface black, titanium-coated</i>
Beispiel-Artikel-Nr. Example Cat. No. 06-04-234	Beispiel-Artikel-Nr. Example Cat. No. 06-04-234B

1/1
YASARGIL
06-04-234
 220 mm
 8¾"



1/1
HUNT
02-04-766
 200 mm
 8"

		Artikel-Nr. Cat. No.	Gesamtlänge Total length
 1/1 ø 3 mm	YASARGIL	02-04-768	200 mm / 8" Maul flach gezahnt, gerade <i>jaw flat toothed, straight</i>
 1/1 ø 5 mm	HUNT	02-04-766	200 mm / 8" Maul flach gezahnt, gerade <i>jaw flat toothed, straight</i>

Standard Line

Oberfläche matt gebürstet
Surface polished

Beispiel-Artikel-Nr.
Example Cat. No. **02-04-766**

Black Line

Oberfläche schwarz, titanbeschichtet
Surface black, titanium-coated

Beispiel-Artikel-Nr.
Example Cat. No. **02-04-766B**

Artikel-Nr. Cat. No.	Gesamtlänge Total length	HUNT	1/1 ø 5 mm
02-04-765	200 mm / 8" Maul flach gezahnt, gewinkelt <i>jaw flat toothed, angled</i>		



Standard Line	Black Line
Oberfläche matt gebürstet <i>Surface polished</i> Beispiel-Artikel-Nr. <i>Example Cat. No.</i> 02-04-765	Oberfläche schwarz, titanbeschichtet <i>Surface black, titanium-coated</i> Beispiel-Artikel-Nr. <i>Example Cat. No.</i> 02-04-765B

1/1
HUNT
02-04-765
200 mm
8"



1/1
06-13-001
 110 mm
 4³/₈"

	Artikel-Nr. Cat. No.	Gesamtlänge Total length
	1/1 06-13-001	110 mm / 4 ³ / ₈ " Spitzen 0,15 mm, gerade <i>tips 0.15 mm, straight</i>
	1/1 06-13-002	110 mm / 4 ³ / ₈ " Spitzen 0,2 mm, gerade <i>tips 0.2 mm, straight</i>
	1/1 06-13-003	110 mm / 4 ³ / ₈ " Spitzen 0,3 mm, gerade <i>tips 0.3 mm, straight</i>
	1/1 06-13-004	110 mm / 4 ³ / ₈ " Spitzen 0,5 mm, gerade <i>tips 0.5 mm, straight</i> 1 x 2 Zähne <i>1 x 2 teeth</i>
	1/1 06-13-005	110 mm / 4 ³ / ₈ " Ring ø 1,2 mm, gerade <i>ø of ring 1.2 mm, straight</i>
	1/1 06-13-006	110 mm / 4 ³ / ₈ " Dreikant 1,2 mm breit, gerade <i>triangular 1.2 mm wide, straight</i>

Standard Line





Oberfläche matt gebürstet
Surface polished

Beispiel-Artikel-Nr. **06-13-001**
Example Cat. No.

Black Line

Oberfläche schwarz, titanbeschichtet
Surface black, titanium-coated

Beispiel-Artikel-Nr. **06-13-001B**
Example Cat. No.

Artikel-Nr. Cat. No.	Gesamtlänge Total length		
06-13-033	160 mm / 6¼"	Spitzen 0,3 mm, gerade tips 0.3 mm, straight	1/1 
06-13-036	160 mm / 6¼"	Spitzen 0,4 mm, gerade tips, 0.4 mm, straight	1/1 
06-13-034	160 mm / 6¼"	Spitzen 0,5 mm, gerade tips 0.5 mm, straight 1 x 2 Zähne 1 x 2 teeth	1/1 
06-13-035	160 mm / 6¼"	Ring ø 1,2 mm, gerade ø of ring 1.2 mm, straight	1/1 



1/1
06-13-033
160 mm
6¼"

Standard Line	Black Line
Oberfläche matt gebürstet Surface polished	Oberfläche schwarz, titanbeschichtet Surface black, titanium-coated
Beispiel-Artikel-Nr. Example Cat. No. 06-13-033	Beispiel-Artikel-Nr. Example Cat. No. 06-13-033B



	Artikel-Nr. Cat. No.	Gesamtlänge Total length
	1/1 06-54-950	150 mm / 6"
	06-54-951	180 mm / 7"
	06-54-952	210 mm / 8¼"
Spitzen 0,6 mm, gerade tips 0.6 mm, straight		
	1/1 06-54-953	150 mm / 6"
	06-54-954	180 mm / 7"
	06-54-955	210 mm / 8¼"
Spitzen 0,6 mm, gebogen tips 0.6 mm, curved		
	1/1 06-54-960	150 mm / 6"
	06-54-961	180 mm / 7"
	06-54-962	210 mm / 8¼"
Spitzen 0,6 mm, gerade tips 0.6 mm, straight		
1 x 2 Zähne 1 x 2 teeth		
	1/1 06-54-963	150 mm / 6"
	06-54-964	180 mm / 7"
	06-54-965	210 mm / 8¼"
Spitzen 0,6 mm, gebogen tips 0.6 mm, curved		
1 x 2 Zähne 1 x 2 teeth		

1/1
06-54-953
 150 mm
 6"

Standard Line

Oberfläche matt gebürstet
 Surface polished

Beispiel-Artikel-Nr. **06-54-953**
 Example Cat. No.

Black Line

Oberfläche schwarz, titanbeschichtet
 Surface black, titanium-coated

Beispiel-Artikel-Nr. **06-54-953B**
 Example Cat. No.

Diamond Line

Maul diamantbeschichtet
 Jaw diamond dust coated

Beispiel-Artikel-Nr. **06-54-953D**
 Example Cat. No.



Artikel-Nr. Cat. No.	Artikel-Nr. Cat. No.	Gesamtlänge Total length		
06-54-980		150 mm / 6"	DE BAKEY	1/1
06-54-981		180 mm / 7"		
06-54-982		210 mm / 8¼"		
		Spitzen 1,2 mm, atraumatisch, gerade <i>tips 1.2 mm, atraumatic, straight</i>		
06-54-983		150 mm / 6"	DE BAKEY	1/1
06-54-984		180 mm / 7"		
06-54-985		210 mm / 8¼"		
		Spitzen 1,2 mm, atraumatisch, gewinkelt <i>tips 1.2 mm, atraumatic, angled</i>		
06-54-970		150 mm / 6"		1/1 ø 1 mm
06-54-971		180 mm / 7"		
06-54-972		210 mm / 8¼"		
		Ringe gerieft, gerade <i>rings serrated, straight</i>		
	06-13-570	150 mm / 6"		1/1 ø 1 mm
	06-13-572	180 mm / 7"		
	06-13-574	210 mm / 8¼"		
		Ringe diamantbeschichtet, gerade <i>rings diamond dust coated, straight</i>		
06-54-973		150 mm / 6"		1/1 ø 2 mm
06-54-974		180 mm / 7"		
06-54-975		210 mm / 8¼"		
		Ringe gerieft, gerade <i>rings serrated, straight</i>		
	06-54-976	150 mm / 6"		1/1 ø 2 mm
	06-13-579	180 mm / 7"		
	06-54-977	210 mm / 8¼"		
		Ringe diamantbeschichtet, gerade <i>rings diamond dust coated, straight</i>		



1/1
 06-54-970
 150 mm
 6"

Standard Line	Black Line
Oberfläche matt gebürstet <i>Surface polished</i>	Oberfläche schwarz, titanbeschichtet <i>Surface black, titanium-coated</i>
Beispiel-Artikel-Nr. Example Cat. No. 06-54-970	Beispiel-Artikel-Nr. Example Cat. No. 06-54-970B

 1/1
 DE BAKEY
 06-54-926
 180 mm
 7"

		TITAN		
		Artikel-Nr. Cat. No.	Artikel-Nr. Cat. No.	Gesamtlänge Total length
1/1	DE BAKEY	06-54-925	06-54-925T	150 mm / 6"
		06-54-926	06-54-926T	180 mm / 7"
		06-54-927	06-54-927T	210 mm / 8¼"
				Spitzen 1,2 mm, gerade tips 1.2 mm, straight
1/1	DE BAKEY	06-54-928	06-54-928T	150 mm / 6"
		06-54-929	06-54-929T	180 mm / 7"
		06-54-930	06-54-930T	210 mm / 8¼"
				Spitzen 1,2 mm, gewinkelt tips 1.2 mm, angled
1/1	DE BAKEY	06-54-931	06-54-931T	150 mm / 6"
		06-54-932	06-54-932T	180 mm / 7"
		06-54-933	06-54-933T	210 mm / 8¼"
				Spitzen 1,8 mm, gerade tips 1.8 mm, straight
1/1	DE BAKEY	06-54-934	06-54-934T	150 mm / 6"
		06-54-935	06-54-935T	180 mm / 7"
		06-54-936	06-54-936T	210 mm / 8¼"
				Spitzen 1,8 mm, gewinkelt tips 1.8 mm, angled

Standard Line





 Oberfläche matt gebürstet
 Surface polished

 Beispiel-Artikel-Nr.
 Example Cat. No. **06-54-926**
Black Line

 Oberfläche schwarz, titanbeschichtet
 Surface black, titanium-coated

 Beispiel-Artikel-Nr.
 Example Cat. No. **06-54-926B**

TITAN

Artikel-Nr. Cat. No.	Artikel-Nr. Cat. No.	Gesamtlänge Total length	
06-54-937	06-54-937T	150 mm / 6"	1/1 ø 1 mm
06-54-938	06-54-938T	180 mm / 7"	
06-54-939	06-54-939T	210 mm / 8¼"	
		Ringe gerieft, gerade rings serrated, straight	
06-54-940	06-54-940T	150 mm / 6"	1/1 ø 1 mm
06-54-941	06-54-941T	180 mm / 7"	
06-54-942	06-54-942T	210 mm / 8¼"	
		Ringe diamantbeschichtet, gerade rings diamond dust coated, straight	
06-54-943	06-54-943T	150 mm / 6"	1/1 ø 2 mm
06-54-944	06-54-944T	180 mm / 7"	
06-54-945	06-54-945T	210 mm / 8¼"	
		Ringe gerieft, gerade rings serrated, straight	
06-54-946	06-54-946T	150 mm / 6"	1/1 ø 2 mm
06-54-947	06-54-947T	180 mm / 7"	
06-54-948	06-54-948T	210 mm / 8¼"	
		Ringe diamantbeschichtet, gerade rings diamond dust coated, straight	



1/1
06-54-938
180 mm
7"

Standard Line	Black Line
<p>Oberfläche matt gebürstet Surface polished</p> <p>Beispiel-Artikel-Nr. Example Cat. No. 06-54-938</p>	<p>Oberfläche schwarz, titanbeschichtet Surface black, titanium-coated</p> <p>Beispiel-Artikel-Nr. Example Cat. No. 06-54-938B</p>

TITAN

	Artikel-Nr. Cat. No.	Artikel-Nr. Cat. No.	Gesamtlänge Total length
1/1	06-04-280		120 mm / 4¾"
	06-04-284	06-04-284T	150 mm / 6"
	06-54-286	06-54-286T	180 mm / 7"
	06-54-288	06-54-288T	210 mm / 8¼"
			Spitzen 0,3 mm, gerade tips 0.3 mm, straight
1/1	06-54-280		120 mm / 4¾"
	06-54-284	06-54-284T	150 mm / 6"
	06-04-286	06-04-286T	180 mm / 7"
	06-54-290	06-54-290T	210 mm / 8¼"
	06-04-288		230 mm / 9"
			Spitzen 0,6 mm, gerade tips 0.6 mm, straight
1/1	06-04-281		120 mm / 4¾"
	06-04-285	06-04-285T	150 mm / 6"
	06-54-287	06-54-287T	180 mm / 7"
	06-54-289	06-54-289T	210 mm / 8¼"
			Spitzen 0,3 mm, gebogen tips 0.3 mm, curved
1/1	06-54-281		120 mm / 4¾"
	06-54-285	06-54-285T	150 mm / 6"
	06-04-287	06-04-287T	180 mm / 7"
	06-54-291	06-54-291T	210 mm / 8¼"
	06-54-293		230 mm / 9"
			Spitzen 0,6 mm, gebogen tips 0.6 mm, curved

1/1
06-04-284
 150 mm
 6"

Standard Line

Oberfläche matt gebürstet
 Surface polished

Beispiel-Artikel-Nr.
 Example Cat. No. **06-04-284**

Black Line



Oberfläche schwarz, titanbeschichtet
 Surface black, titanium-coated

Beispiel-Artikel-Nr.
 Example Cat. No. **06-04-284B**

Diamond Line

Maul diamantbeschichtet
 Jaw diamond dust coated

Beispiel-Artikel-Nr.
 Example Cat. No. **06-04-284D**

Artikel-Nr. Cat. No.	Gesamtlänge Total length		
02-04-260	155 mm / 6" Spitzen 0,5 mm, gerade tips 0.5 mm, straight	LAZAR	1/1 
02-04-261	155 mm / 6" Spitzen 0,8 mm, gerade tips 0.8 mm, straight	LAZAR	1/1 
02-04-264	185 mm / 7¼" Spitzen 0,5 mm, gerade tips 0.5 mm, straight		1/1 







1/1
LAZAR
02-04-261
155 mm
6"

 **Diamond Line**

Maul diamantbeschichtet
Jaw diamond dust coated





Beispiel-Artikel-Nr. **02-04-261D**
Example Cat. No.

 1/1
WISE
02-04-336
 135 mm
 5¼"

		Artikel-Nr. Cat. No.	Gesamtlänge Total length
1/1		02-04-338	120 mm / 4¾" Spitzen 0,3 mm, gerade tips 0.3 mm, straight
1/1	WISE 	02-04-336	135 mm / 5¼" Spitzen 0,3 mm, gerade tips 0.3 mm, straight
1/1	WISE 	02-04-337	135 mm / 5¼" Spitzen 0,3 mm, gebogen tips 0.3 mm, curved
1/1	WISE 	02-04-345	135 mm / 5¼" 1 x 2 Zähne, gerade 1 x 2 teeth, straight

 **Diamond Line**
Maul diamantbeschichtet
Jaw diamond dust coated

 Beispiel-Artikel-Nr. **02-04-336D**
 Example Cat. No.

Artikel-Nr. Cat. No.	Gesamtlänge Total length	
02-04-331	110 mm / 4 ³ / ₈ " Spitzen 0,15 mm, gerade <i>tips 0.15 mm, straight</i>	1/1 
02-04-330	110 mm / 4 ³ / ₈ " Spitzen 0,2 mm, gerade <i>tips 0.2 mm, straight</i>	1/1 
02-04-329	110 mm / 4 ³ / ₈ " Spitzen 0,3 mm, gewinkelt <i>tips 0.3 mm, angled</i>	1/1 
02-04-333	115 mm / 4 ¹ / ₂ " Spitzen 0,2 mm, gebogen <i>tips 0.2 mm, curved</i>	1/1 



1/1
02-04-331
 110 mm
 4³/₈"

Diamond Line
 Maul diamantbeschichtet
Jaw diamond dust coated
 Beispiel-Artikel-Nr. **02-04-331D**
 Example Cat. No.



2/3
06-54-315
 135 mm
 5¼"

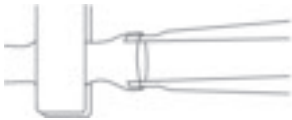

1/1

Artikel-Nr.
Cat. No.
06-54-313
Gesamtlänge
Total length

110 mm / 4¾"

 Spitzen 0,2 mm, 10° gewinkelt
 tips 0.2 mm, 10° angled

1/1

06-54-314

110 mm / 4¾"

 Spitzen 0,3 mm, 10° gewinkelt
 tips 0.3 mm, 10° angled

1/1

06-54-315

135 mm / 5¼"

 Spitzen 0,2 mm, gerade
 tips 0.2 mm, straight

1/1

06-54-316

135 mm / 5¼"

 Spitzen 0,3 mm, gerade
 tips 0.3 mm, straight

2/3
06-54-317
 135 mm
 5¼"







1/1

Artikel-Nr.
Cat. No.
06-54-317
Gesamtlänge
Total length

135 mm / 5¼"

 Spitzen 0,3 mm, gewinkelt
 tips 0.3 mm, angled

Artikel-Nr. Cat. No.	Gesamtlänge Total length		
02-02-046	135 mm / 5¼"		1/1 
02-02-048	155 mm / 6"		1/1 
02-02-052	180 mm / 7"	CASPAR	1/1 
02-02-054	200 mm / 8"		1/1 



1/1
02-02-054
200 mm
8"



	Artikel-Nr. Cat. No.	Gesamtlänge Total length
	LANDOLT	02-02-053
		210 mm / 8¼"
		für mikrochirurgische Klagen for microsurgery blades

1/1
LANDOLT
02-02-053
210 mm
8¼"

Artikel-Nr. Cat. No.	Gesamtlänge Total length	LANDOLT	1/2
02-02-057	250 mm / 10"	für mikrochirurgische Klengen for microsurgery blades	



2/3
LANDOLT
02-02-057
250 mm
10"

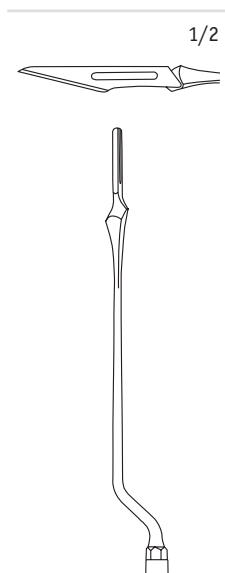

Artikel-Nr.
Cat. No.

Gesamtlänge
Total length

02-02-071

210 mm / 8¼"

02-52-070

240 mm / 9½"

horizontal
horizontal

02-52-071

210 mm / 8¼"

02-52-072

240 mm / 9½"

vertikal
vertical

1/1
LANDOLT
02-02-071
210 mm
8"

Artikel-Nr. Cat. No.	Gesamtlänge Total length		
06-04-361	105 mm / 4 1/8"		
	Metallgriff für auswechselbare Mikroschäfte, 360° drehbar <i>metal handle for micro-shaft instruments, 360° turnable</i>		



2/3
06-04-361
 105 mm
 4 1/8"

Artikel-Nr. Cat. No.	Gesamtlänge Total length		
06-54-361	155 mm / 6 1/4"		
	Kunststoffgriff für auswechselbare Mikroschäfte, 360° drehbar, mit Gegengewicht <i>plastic handle for micro-shaft instruments, 360° turnable, with counter balance</i>		



2/3
06-54-361
 155 mm
 6 1/4"



2/3
13-56-100
 160 mm
 6¼"

Artikel-Nr.
Cat. No.

13-56-100

Gesamtlänge
Total length

160 mm / 6¼"

Metallgriff für auswechselbare Mikroschäfte, bajonettförmig, in der Länge variabel einstellbar, 360° drehbar

metal handle, bayonet-shaped, for micro-shaft instruments, shaft length adjustable, 360° turnable

Artikel-Nr.
Cat. No.

13-56-000





Gesamtlänge
Total length

170 mm / 6¾"

Kunststoffgriff für auswechselbare Mikroschäfte, bajonettförmig, in der Länge variabel einstellbar, 360° drehbar, mit Gegengewicht

plastic handle, bayonet-shaped, for micro-shaft instruments, shaft length adjustable, 360° turnable, with counter balance

2/3
13-56-000
 170 mm
 6¾"

Artikel-Nr. Cat. No.	Schaftlänge Length of shaft		
13-56-001	150 mm / 6" 90° klein 90° small	CASPAR modif.	1/1 
13-56-002	150 mm / 6" 90° mittel 90° medium	CASPAR modif.	1/1 
13-56-003	150 mm / 6" 90° groß 90° large	CASPAR modif.	1/1 
13-56-004	150 mm / 6" 45° mittel 45° medium	CASPAR modif.	1/1 

Zur Verwendung mit den Griffen
for use with handles

13-56-000
 13-56-100
 06-04-361
 06-54-361









1/2
Griff
handle

1/1
CASPAR modif.
13-56-001
150 mm
6"

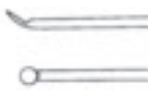

1/1
RHOTON modif.
13-56-008
 150 mm
 6"

TITAN

		Artikel-Nr. Cat. No.	Artikel-Nr. Cat. No.	Schaftlänge Length of shaft
	1/1 1 mm RHOTON modif.	13-56-005	13-56-005T	150 mm / 6" Dissektor, rund, Nr. 1 <i>dissector, round, no. 1</i>
	1/1 2 mm RHOTON modif.	13-56-006	13-56-006T	150 mm / 6" Dissektor, rund, Nr. 2 <i>dissector, round, no. 2</i>
	1/1 3 mm RHOTON modif.	13-56-007	13-56-007T	150 mm / 6" Dissektor, rund, Nr. 3 <i>dissector, round, no. 3</i>
	1/1 1,2 mm RHOTON modif.	13-56-008	13-56-008T	150 mm / 6" Elevatorium, gewinkelt, Nr. 4 <i>elevator, angled, no. 4</i>
	1/1 2,8 mm RHOTON modif.	13-56-009	13-56-009T	150 mm / 6" Elevatorium, gebogen, Nr. 5 <i>elevator, curved, no. 5</i>
	1/1 1 mm RHOTON modif.	13-56-010	13-56-010T	150 mm / 6" Dissektor, klein, Nr. 6 <i>dissector, small, no. 6</i>
	1/1 1,5 mm RHOTON modif.	13-56-011	13-56-011T	150 mm / 6" Dissektor, mittel, Nr. 7 <i>dissector, medium, no. 7</i>
	1/1 2 mm RHOTON modif.	13-56-012	13-56-012T	150 mm / 6" Dissektor, groß, Nr. 8 <i>dissector, large, no. 8</i>

Zur Verwendung mit den Griffen
 for use with handles
13-56-000
13-56-100
06-04-361
06-54-361

TITAN

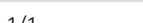
Artikel-Nr. Cat. No.	Artikel-Nr. Cat. No.	Schaftlänge Length of shaft		
13-56-013	13-56-013T	150 mm / 6" Häkchen, halbscharf, gewinkelt 90°, Nr. 9 <i>hook, semi-sharp, angled 90°, no. 9</i>	RHOTON modif.	1/1 
13-56-014	13-56-014T	150 mm / 6" Häkchen, stumpf, gewinkelt 90°, Nr. 10 <i>hook, blunt, angled 90°, no. 10</i>	RHOTON modif.	1/1 
13-56-015	13-56-015T	150 mm / 6" Häkchen, halbscharf, gewinkelt 45°, Nr. 11 <i>hook, semi-sharp, angled 45°, no. 11</i>	RHOTON modif.	1/1 
13-56-016	13-56-016T	150 mm / 6" Nadel, gerade, Nr. 12 <i>needle, straight, no. 12</i>	RHOTON modif.	1/1 
13-56-017	13-56-017T	150 mm / 6" Kürette, klein, Nr. 13 <i>curette, small, no. 13</i>	RHOTON modif.	1/1 
13-56-018	13-56-018T	150 mm / 6" Kürette, groß, Nr. 14 <i>curette, large, no. 14</i>	RHOTON modif.	1/1 
13-56-019	13-56-019T	150 mm / 6" Kugeldissektor, gerade, Nr. 15 <i>teardrop dissector, straight, no. 15</i>	RHOTON modif.	1/1 
13-56-020	13-56-020T	150 mm / 6" Kugeldissektor, 90° gewinkelt, Nr. 16 <i>teardrop dissector, 90° angled, no. 16</i>	RHOTON modif.	1/1 
13-56-021	13-56-021T	150 mm / 6" Kugeldissektor, 90° gewinkelt, Nr. 17 <i>teardrop dissector, 90° angled, no. 17</i>	RHOTON modif.	1/1 
13-56-022	13-56-022T	150 mm / 6" Kugeldissektor, 40° gewinkelt, Nr. 18 <i>teardrop dissector, 40° angled, no. 18</i>	RHOTON modif.	1/1 
13-56-023	13-56-023T	150 mm / 6" Kugeldissektor, 40° gewinkelt, Nr. 19 <i>teardrop dissector, 40° angled, no. 19</i>	RHOTON modif.	1/1 







1/2
Griff
handle



1/1
RHOTON modif.
13-56-013
150 mm
6"

Zur Verwendung mit den Griffen
 for use with handles
 13-56-000
 13-56-100
 06-04-361
 06-54-361

TITAN

		Artikel-Nr. Cat. No.	Artikel-Nr. Cat. No.	Schaftlänge Length of shaft
	1/1 YASARGIL modif.	13-56-043	13-56-043T	150 mm / 6" Raspatorium, gewinkelt <i>raspatory, angled</i>
	1/1 YASARGIL modif.	13-56-044	13-56-044T	150 mm / 6" Raspatorium, gewinkelt <i>raspatory, angled</i>
	1/1 YASARGIL modif.	13-56-045	13-56-045T	150 mm / 6" Raspatorium, gebogen <i>raspatory, curved</i>
	1/1 YASARGIL modif.	13-56-046	13-56-046T	150 mm / 6" Raspatorium, gebogen <i>raspatory, curved</i>
	1/1	13-56-047	13-56-047T	150 mm / 6" Raspatorium, plattenförmig <i>raspatory, round blade</i>
	1/1	13-56-048	13-56-048T	150 mm / 6" Raspatorium, plattenförmig <i>raspatory, round blade</i>
	1/1 CASPAR modif.	13-56-049	13-56-049T	150 mm / 6" Dissektor, gebogen <i>dissector, curved</i>

 Zur Verwendung mit den Griffen
 for use with handles

13-56-000







13-56-100

06-04-361

06-54-361

 1/2
 Griff
 handle

 1/1
YASARGIL modif.
13-56-043
 150 mm
 6"

Artikel-Nr. Cat. No.	Schaftlänge Length of shaft		
13-56-039	150 mm / 6"	KOOS modif.	1/1 
13-56-040	150 mm / 6"	KOOS modif.	1/1 
13-56-041	150 mm / 6"	KOOS modif.	1/1 
13-56-042	150 mm / 6"	KOOS modif.	1/1 
13-56-056	150 mm / 6"	JACOBSON	1/1 
13-56-057	150 mm / 6"		1/1 

Zur Verwendung mit den Griffen
 for use with handles
 13-56-000
 13-56-100
 06-04-361
 06-54-361







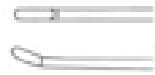

1/2
Griff
handle

1/1
KOOS modif.
13-56-039
150 mm
6"









 1/1
SAMII modif.
13-56-029
 150 mm
 6"

TITAN

		Artikel-Nr. Cat. No.	Artikel-Nr. Cat. No.	Schaftlänge Length of shaft
	1/1 1,0 mm SAMII modif.	13-56-024	13-56-024T	150 mm / 6" Tumormesser tumor knife
	1/1 1,5 mm SAMII modif.	13-56-025	13-56-025T	150 mm / 6" Tumormesser tumor knife
	1/1 2,0 mm SAMII modif.	13-56-026	13-56-026T	150 mm / 6" Tumormesser tumor knife
	1/1 2,5 mm SAMII modif.	13-56-027	13-56-027T	150 mm / 6" Tumormesser tumor knife
	1/1 3,0 mm SAMII modif.	13-56-028	13-56-028T	150 mm / 6" Tumormesser tumor knife
	1/1 3,5 mm SAMII modif.	13-56-029	13-56-029T	150 mm / 6" Tumormesser tumor knife
	1/1 4,0 mm SAMII modif.	13-56-030	13-56-030T	150 mm / 6" Tumormesser tumor knife
	1/1 5,0 mm SAMII modif.	13-56-031	13-56-031T	150 mm / 6" Tumormesser tumor knife

 Zur Verwendung mit den Griffen
 for use with handles
13-56-000
13-56-100
06-04-361
06-54-361

TITAN

Artikel-Nr. Cat. No.	Artikel-Nr. Cat. No.	Schaftlänge Length of shaft		
13-56-032	13-56-032T	150 mm / 6"	Tumormesser tumor knife	SAMII modif. 1/1 ø 1,5 mm 
13-56-033	13-56-033T	150 mm / 6"	Tumormesser tumor knife	SAMII modif. 1/1 ø 3 mm 
13-56-034	13-56-034T	150 mm / 6"	Tumormesser tumor knife	SAMII modif. 1/1 ø 4,5 mm 
13-56-035	13-56-035T	150 mm / 6"	Tumormesser tumor knife	SAMII modif. 1/1 ø 6 mm 
13-56-036	13-56-036T	150 mm / 6"	Lanzettenmesser lancet knife	SAMII modif. 1/1 1,8 mm 
13-56-037	13-56-037T	150 mm / 6"	Lanzettenmesser lancet knife	SAMII modif. 1/1 2,5 mm 
13-56-038	13-56-038T	150 mm / 6"	Mikro-Lanzettenmesser, biegsam, für Akustikusneurinom micro lancet knife, malleable, for acoustic neurinoma	OPPEL modif. 1/1 ø 2 mm 

1/2
Griff
handle



1/1
SAMII modif.
13-56-033
150 mm
6"

Zur Verwendung mit den Griffen
 for use with handles
 13-56-000
 13-56-100
 06-04-361
 06-54-361



		TITAN		
		Artikel-Nr. Cat. No.	Artikel-Nr. Cat. No.	Gesamtlänge Total length
1/1 1 mm	RHOTON	06-54-320	06-54-320T	190 mm / 7½"
				Dissektor, rund Nr. 1 <i>dissector, round no. 1</i>
1/1 2 mm	RHOTON	06-54-321	06-54-321T	190 mm / 7½"
				Dissektor, rund Nr. 2 <i>dissector, round no. 2</i>
1/1 3 mm	RHOTON	06-54-322	06-54-322T	190 mm / 7½"
				Dissektor, rund Nr. 3 <i>dissector, round no. 3</i>
1/1 1,2 mm	RHOTON	06-54-323	06-54-323T	190 mm / 7½"
				Elevatorium, gewinkelt, Nr. 4 <i>elevator, angled no. 4</i>
1/1 2,8 mm	RHOTON	06-54-324	06-54-324T	190 mm / 7½"
				Elevatorium, gebogen, Nr. 5 <i>elevator, curved, no. 5</i>
1/1 1 mm	RHOTON	06-54-325	06-54-325T	190 mm / 7½"
				Dissektor, klein, Nr. 6 <i>dissector, small, no. 6</i>
1/1 1,5 mm	RHOTON	06-54-326	06-54-326T	190 mm / 7½"
				Dissektor, mittel, Nr. 7 <i>dissector, medium, no. 7</i>
1/1 2 mm	RHOTON	06-54-327	06-54-327T	190 mm / 7½"
				Dissektor, groß, Nr. 8 <i>dissector, large, no. 8</i>

1/1
RHOTON
06-54-323
 190 mm
 7½"

Lagerungstray siehe Seite 119-121
storage tray see page 119-121

TITAN







Artikel-Nr. Cat. No.	Artikel-Nr. Cat. No.	Gesamtlänge Total length		
06-54-328	06-54-328T	190 mm / 7½"	RHOTON	1/1 
		Häkchen, halbscharf, gewinkelt 90°, Nr. 9 <i>hook, semi-sharp, angled 90°, no. 9</i>		
06-54-329	06-54-329T	190 mm / 7½"	RHOTON	1/1 
		Häkchen, stumpf, gewinkelt 90°, Nr. 10 <i>hook, blunt, angled 90°, no. 10</i>		
06-54-330	06-54-330T	190 mm / 7½"	RHOTON	1/1 
		Häkchen, halbscharf, gewinkelt 45°, Nr. 11 <i>hook, semi-sharp, angled 45°, no. 11</i>		
06-54-331	06-54-331T	190 mm / 7½"	RHOTON	1/1 
		Nadel, gerade, Nr. 12 <i>needle, straight, no. 12</i>		
06-54-332	06-54-332T	190 mm / 7½"	RHOTON	1/1 
		Kürette, klein, Nr. 13 <i>curette, small, no. 13</i>		
06-54-333	06-54-333T	190 mm / 7½"	RHOTON	1/1 
		Kürette, groß, Nr. 14 <i>curette, large, no. 14</i>		
06-54-334	06-54-334T	190 mm / 7½"	RHOTON	1/1 
		Kugeldissektor, gerade, Nr. 15 <i>teardrop dissector, straight, no. 15</i>		
06-54-335	06-54-335T	190 mm / 7½"	RHOTON	1/1 
		Kugeldissektor, 90° gewinkelt, Nr. 16 <i>teardrop dissector, 90° angled, no. 16</i>		
06-54-336	06-54-336T	190 mm / 7½"	RHOTON	1/1 
		Kugeldissektor, 90° gewinkelt, Nr. 17 <i>teardrop dissector, 90° angled, no. 17</i>		
06-54-337	06-54-337T	190 mm / 7½"	RHOTON	1/1 
		Kugeldissektor, 40° gewinkelt, Nr. 18 <i>teardrop dissector, 40° angled, no. 18</i>		
06-54-338	06-54-338T	190 mm / 7½"	RHOTON	1/1 
		Kugeldissektor, 40° gewinkelt, Nr. 19 <i>teardrop dissector, 40° angled, no. 19</i>		









1/1
RHOTON
06-54-328
190 mm
7½"

Lagerungstray siehe Seite 119-121
storage tray see page 119-121

 1/1
CASPAR
02-20-088
 245 mm
 9¾"

		TITAN		
		Artikel-Nr. Cat. No.	Artikel-Nr. Cat. No.	Gesamtlänge Total length
	1/1 CASPAR	02-20-088	02-20-088T	245 mm / 9¾"
		02-70-088	02-70-088T	245 mm / 9¾"
	1/1 CASPAR	02-20-089	02-20-089T	245 mm / 9¾"
		02-70-089	02-70-089T	245 mm / 9¾"
	1/1 CASPAR	02-20-090	02-20-090T	245 mm / 9¾"
		02-70-090	02-70-090T	245 mm / 9¾"
	1/1 CASPAR	02-20-091	02-20-091T	245 mm / 9¾"
		02-70-091	02-70-091T	245 mm / 9¾"
	1/1 CASPAR	02-20-091	02-20-091T	245 mm / 9¾"
		02-70-091	02-70-091T	245 mm / 9¾"
	1/1 CASPAR	02-20-091	02-20-091T	245 mm / 9¾"
		02-70-091	02-70-091T	245 mm / 9¾"

TITAN



Artikel-Nr. Cat. No.	Artikel-Nr. Cat. No.	Gesamtlänge Total length		
06-04-330	06-04-330T	230 mm / 9" halbscharf semi sharp		1/1 
06-04-331	06-04-331T	230 mm / 9" stumpf blunt		1/1 
06-04-375	06-04-375T	185 mm / 7¼" scharf, gebogen sharp, curved		1/1 
06-04-376	06-04-376T	185 mm / 7¼" scharf, abgewinkelt sharp, angled	FISCH	1/1 
06-04-430	06-04-430T	230 mm / 9" Knopfhäkchen 90°, biegsam, für Akustikusneurinom <i>hook 90°, malleable, for acoustic neurinoma</i>	OPPEL	1/1 
06-04-432	06-04-432T	230 mm / 9" Knopfhäkchen 45°, biegsam, für Akustikusneurinom <i>hook 45°, malleable, for acoustic neurinoma</i>	OPPEL	1/1 



1/1
06-04-331
230 mm
9"



1/1
SPETZLER
06-54-311
 240 mm
 9½"

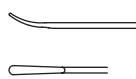





		TITAN		
		Artikel-Nr. Cat. No.	Artikel-Nr. Cat. No.	Gesamtlänge Total length
1/1	SPETZLER	06-54-310	06-54-310T	240 mm / 9½"
				Kugelhäkchen, 30° aufwärts gebogen <i>teardrop, 30° curved up</i>
1/1	SPETZLER	06-54-311	06-54-311T	240 mm / 9½"
				Kugelhäkchen, 90° aufwärts gebogen <i>teardrop, 90° curved up</i>
1/1	SPETZLER	06-54-312	06-54-312T	240 mm / 9½"
				Dissektor, aufwärts gebogen <i>dissector, curved up</i>

Artikel-Nr. Cat. No.	Gesamtlänge Total length			
06-04-270	185 mm / 7¼"	Fadenführer, geknöpft <i>ligature guide, probe pointed</i>	YASARGIL	1/1
06-04-271	185 mm / 7¼"	Fadenführer, geknöpft <i>ligature guide, probe pointed</i>	YASARGIL	1/1
06-04-272	185 mm / 7¼"	Fadenführer, geknöpft <i>ligature guide, probe pointed</i>	YASARGIL	1/1
06-04-273	185 mm / 7¼"	Fadenführer, geknöpft <i>ligature guide, probe pointed</i>	YASARGIL	1/1
06-04-396	185 mm / 7¼"	Nerv- und Gefäßhäkchen <i>nerve and vessel hook</i>	KRAYEN- BÜHL	1/1
06-04-397	185 mm / 7¼"	Nerv- und Gefäßhäkchen <i>nerve and vessel hook</i>	KRAYEN- BÜHL	1/1
06-04-398	185 mm / 7¼"	Nerv- und Gefäßhäkchen <i>nerve and vessel hook</i>	KRAYEN- BÜHL	1/1
06-04-399	185 mm / 7¼"	Nerv- und Gefäßhäkchen <i>nerve and vessel hook</i>	KRAYEN- BÜHL	1/1







1/1
KRAYENBÜHL
06-04-396
185 mm
7¼"

 1/2
FRAZIER
 06-06-321
 130 mm
 5 1/8"

		Artikel-Nr. Cat. No.	Gesamtlänge Total length
1/1	 CAIRNS	06-06-313	130 mm / 5 1/8"
1/1	 FRAZIER	06-06-321	130 mm / 5 1/8"
1/1	 TOENNIS	06-06-322	150 mm / 6"
1/1	 GRAEFE	15-01-332	125 mm / 5"
1/1	 GRAEFE	15-01-333	125 mm / 5"
1/1	 JÄGER	15-01-351	135 mm / 5 3/4"

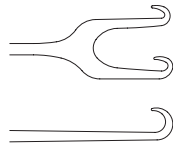
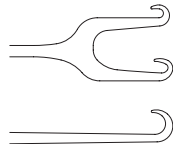

 1/2
GILLIES
 15-12-611
 180 mm
 7"

		Artikel-Nr. Cat. No.	Gesamtlänge Total length
1/1	 GILLIES	15-12-611	180 mm / 7"
1/1	 GILLIES	15-12-612	180 mm / 7"
1/1	 COTTLE	15-12-619	160 mm / 6 3/4"
	 COTTLE	15-12-617	160 mm / 6 3/4"
	 FREER	15-12-621	150 mm / 6"

Artikel-Nr. Cat. No.	Gesamtlänge Total length		
15-12-615	150 mm / 6"	MC INDOE	9 mm 
15-12-616	150 mm / 6"	MC INDOE	10 mm 



2/3
MC INDOE
15-12-615
150 mm
6"

Artikel-Nr. Cat. No.	Gesamtlänge Total length		
15-12-610	160 mm / 6¼"	KILNER	





2/3
KILNER
15-12-610
160 mm
6¼"



1/1
JOSEPH
15-12-620
165 mm
6½"

		Artikel-Nr. Cat. No.	Gesamtlänge Total length
	JOSEPH	15-12-620	165 mm / 6½"
2 mm 	JOSEPH	15-12-622	165 mm / 6½"
5 mm 	JOSEPH	15-12-623	165 mm / 6½"
7 mm 	JOSEPH	15-12-624	165 mm / 6½"
10 mm 	JOSEPH	13-04-581	165 mm / 6½"

Artikel-Nr. Cat. No.	Gesamtlänge Total length		
15-12-601	160 mm / 6¼"	KLEINERT-KUTZ	3 mm 
15-12-602	160 mm / 6¼"	KLEINERT-KUTZ	5 mm 
15-12-603	160 mm / 6¼"	KLEINERT-KUTZ	7 mm 









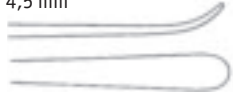

1/1
KLEINERT-KUTZ
15-12-603
160 mm
6¼"

 1/1
CASPAR
06-06-305
 230 mm
 9"

		TITAN		
		Artikel-Nr. Cat. No.	Artikel-Nr. Cat. No.	Gesamtlänge Total length
1/1 4,5 mm	CASPAR	06-06-305	06-06-305T	230 mm / 9" abwärts gebogen <i>curved down</i>
1/1 2 mm	CASPAR	06-06-307	06-06-307T	230 mm / 9" abwärts gebogen <i>curved down</i>
1/1 2 mm	HARDY	06-56-307	06-56-307T	230 mm / 9" aufwärts gebogen <i>curved up</i>
1/1 1,8 mm		06-04-343	06-04-343T	230 mm / 9" aufwärts gebogen <i>curved up</i>
1/1 1,8 mm		06-04-344	06-04-344T	230 mm / 9" abwärts gebogen <i>curved down</i>
1/1 1 mm	CASPAR	06-06-312	06-06-312T	210 mm / 8¼" abwärts gebogen <i>curved down</i>
1/1 1 mm	CASPAR	06-06-311	06-06-311T	210 mm / 8¼" aufwärts gebogen <i>curved up</i>

TITAN

Artikel-Nr. Cat. No.	Artikel-Nr. Cat. No.	Gesamtlänge Total length		
06-06-303	06-06-303T	230 mm / 9"	CASPAR	1/1 4,5 mm 
06-04-333	06-04-333T	230 mm / 9"		1/1 2 mm 
06-04-334	06-04-334T	230 mm / 9"		1/1 1,8 mm 
06-04-332	06-04-332T	230 mm / 9"		1/1 1,4 mm 
06-04-429	06-04-429T	230 mm / 9"	OPPEL	1/1 1 mm 
06-06-310	06-06-310T	200 mm / 8"	CASPAR	1/1 1 mm 
06-02-150	06-02-150T	185 mm / 7¼"		1/1 3 mm 
06-02-151	06-02-151T	215 mm / 8½"		1/1 3 mm 



1/1
06-06-303
230 mm
9"

1/2
PENFIELD
06-06-293
 195 mm
 7¾"

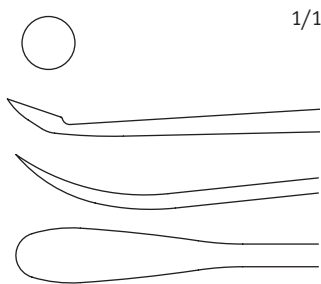

1/1

PENFIELD
Artikel-Nr.
Cat. No.
06-06-291
Gesamtlänge
Total length

175 mm / 7"

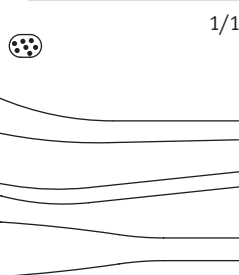
 #1
 doppelendig
 double ended

1/1

PENFIELD**06-06-292**

195 mm / 7¾"

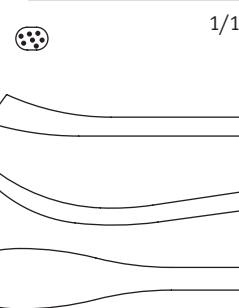
 #2
 doppelendig
 double ended

1/1

PENFIELD**06-06-293**

195 mm / 7¾"

 #3
 doppelendig
 double ended

1/2
PENFIELD
06-06-294
 205 mm
 8"

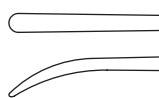

1/1

PENFIELD**06-06-294**

205 mm / 8"

 #4
 einendig
 single ended



1/1

PENFIELD**06-06-295**

290 mm / 11½"

 #5
 doppelendig
 double ended

1/2
PENFIELD
06-06-295
 290 mm
 11½"

Artikel-Nr. Cat. No.	Gesamtlänge Total length		
06-06-301	240 mm / 9½"	TOENNIS	1/1
	stumpf – stumpf blunt – blunt		
06-06-302	240 mm / 9½"	TOENNIS	1/1
	stumpf – stumpf blunt – blunt		

1/2
TOENNIS
06-06-302
240 mm
9½"

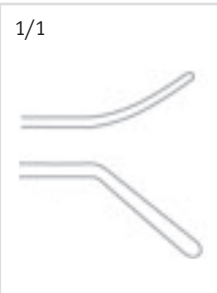

Artikel-Nr. Cat. No.	Gesamtlänge Total length		
06-06-349	230 mm / 9"	PENNY-BACKER	1/1
	Sonde und Dissektor probe and dissector		

1/2
PENNYBACKER
06-06-349
230 mm
9"

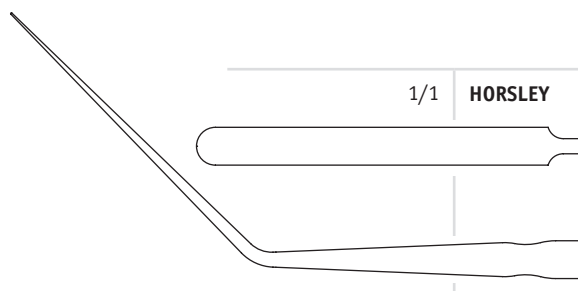

Artikel-Nr.
Cat. No.
Gesamtlänge
Total length

 1/1 **HORSLEY**
06-56-305

200 mm / 8"

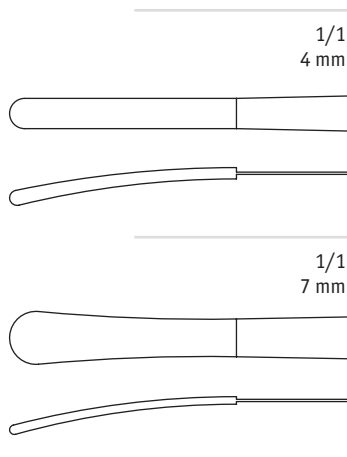
 1/2
HORSLEY
06-56-305
 200 mm
 8"

Artikel-Nr.
Cat. No.
Gesamtlänge
Total length

 1/1 **YASARGIL**
 4 mm

06-06-326

195 mm / 7¾"

 für Kinder, mit flexiblem Schaft
 for children, with flexible shaft

 1/1 **YASARGIL**
 7 mm

06-06-327

195 mm / 7¾"

 für Erwachsene, mit flexiblem Schaft
 for adults, with flexible shaft

 1/2
YASARGIL
06-06-326
 195 mm
 7¾"

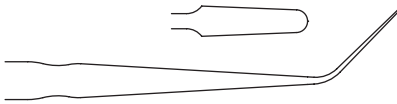
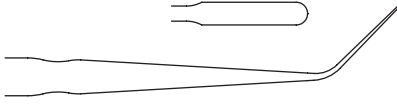
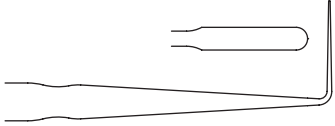
Artikel-Nr. Cat. No.	Gesamtlänge Total length		
06-56-302	150 mm / 6"	FRAZIER	1/1 4 mm 
06-56-303	150 mm / 6"	HOEN	1/1 3 mm 
06-56-304	150 mm / 6"	HOEN	1/1 3 mm 



1/1
HOEN
06-56-303
150 mm
6"





		Artikel-Nr. Cat. No.	Gesamtlänge Total length
1/1	ALLEN	06-06-346	230 mm / 9"
			Osteophytenmeißel und Schaber <i>osteophyte chisel and scraper</i>

1/1
ALLEN
06-06-346
230 mm
9"

Artikel-Nr. Cat. No.	Gesamtlänge Total length		
15-12-160	180 mm / 7"	HALLE	1/1 3,3 mm
	Raspatorium, stumpf <i>raspatory, blunt</i>		



1/2
HALLE
15-12-160
180 mm
7"

Artikel-Nr. Cat. No.	Gesamtlänge Total length		
04-15-611	150 mm / 6"	PARTSCH	1/1 3,2 mm
	Raspatorium <i>raspatory</i>		
04-15-612	150 mm / 6"	PARTSCH	1/1 4,6 mm
	Raspatorium <i>raspatory</i>		
04-15-642	145 mm / 5 3/4"	PARTSCH	1/1 4 mm
	Raspatorium <i>raspatory</i>		



1/2
PARTSCH
04-15-612
150 mm
6"







 1/2
KILIAN
15-12-170
 185 mm
 7¼"

 1/2
FREER
15-12-162
 190 mm
 7½"

		Artikel-Nr. Cat. No.	Gesamtlänge Total length
1/1	FREER-YASARGIL	15-12-166	185 mm / 7¼" Elevatorium <i>elevator</i> scharf – scharf <i>sharp – sharp</i>
1/1	FREER	15-12-165	185 mm / 7¼" Elevatorium <i>elevator</i> scharf – stumpf <i>sharp – blunt</i>
1/1	KILLIAN	15-12-170	185 mm / 7¼" Elevatorium <i>elevator</i> scharf – stumpf <i>sharp – blunt</i>
1/1	DAVIS	06-06-300	245 mm / 9¾" Dissektor <i>dissector</i> scharf – stumpf <i>sharp – blunt</i>

		Artikel-Nr. Cat. No.	Gesamtlänge Total length
1/1	FREER	15-12-162	190 mm / 7½" Raspatorium <i>raspatory</i> scharf <i>sharp</i>
		15-12-163	190 mm / 7½" Raspatorium <i>raspatory</i> stumpf <i>blunt</i>





TITAN

Artikel-Nr. Cat. No.	Artikel-Nr. Cat. No.	Gesamtlänge Total length		
06-04-301	06-04-301T	185 mm / 7¼"	YASARGIL	1/1 
06-04-302	06-04-302T	185 mm / 7¼"	YASARGIL	1/1 
06-04-303	06-04-303T	185 mm / 7¼"	YASARGIL	1/1 
06-04-304	06-04-304T	185 mm / 7¼"	YASARGIL	1/1 
06-04-305	06-04-305T	185 mm / 7¼"	YASARGIL	1/1 



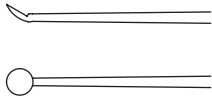



1/1
YASARGIL
06-04-301
 185 mm
 7¼"

 1/1
YASARGIL
06-04-321
 185 mm
 7¼"

		TITAN		
		Artikel-Nr. Cat. No.	Artikel-Nr. Cat. No.	Gesamtlänge Total length
1/1		06-04-346	06-04-346T	230 mm / 9" Raspatorium, aufwärts gebogen <i>raspatory, curved up</i>
1/1		YASARGIL 06-04-320	06-04-320T	185 mm / 7¼" Raspatorium, abwärts gebogen <i>raspatory, curved down</i>
1/1		YASARGIL 06-04-321	06-04-321T	185 mm / 7¼" Raspatorium, abwärts gebogen <i>raspatory, curved down</i>
1/1		YASARGIL 06-04-322	06-04-322T	185 mm / 7¼" Raspatorium, aufwärts gebogen <i>raspatory, curved up</i>
1/1		YASARGIL 06-04-325		185 mm / 7¼" Löffel, scharf, bajonettförmig <i>scoop, sharp, bayonet-shaped</i>
	1/2			









TITAN

Artikel-Nr. Cat. No.	Artikel-Nr. Cat. No.	Gesamtlänge Total length		
06-04-335	06-04-335T	230 mm / 9" Löffel, scharf, gerade <i>scoop, sharp, straight</i>		1/1 
06-04-336	06-04-336T	230 mm / 9" Löffel, scharf, gebogen <i>scoop, sharp, curved</i>		1/1 
06-04-337	06-04-337T	230 mm / 9" Raspatorium, plattenförmig <i>raspatory, round blade</i>		1/1 
06-04-338	06-04-338T	230 mm / 9" Raspatorium, plattenförmig <i>raspatory, round blade</i>		1/1 

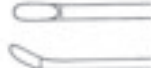







1/1
YASARGIL
06-04-336
 230 mm
 9"

TITAN

		Artikel-Nr. Cat. No.	Artikel-Nr. Cat. No.	Gesamtlänge Total length
1/1 1 mm 	SAMII	06-04-400	06-04-400T	200 mm / 8"
		06-04-410	06-04-410T	230 mm / 9"
1/1 1,5 mm 	SAMII	06-04-401	06-04-401T	200 mm / 8"
		06-04-411	06-04-411T	230 mm / 9"
1/1 2 mm 	SAMII	06-04-402	06-04-402T	200 mm / 8"
		06-04-412	06-04-412T	230 mm / 9"
1/1 2,5 mm 	SAMII	06-04-403	06-04-403T	200 mm / 8"
		06-04-413	06-04-413T	230 mm / 9"
1/1 3 mm 	SAMII	06-04-404	06-04-404T	200 mm / 8"
		06-04-414	06-04-414T	230 mm / 9"
1/1 3,5 mm 	SAMII	06-04-405	06-04-405T	200 mm / 8"
		06-04-415	06-04-415T	230 mm / 9"
1/1 4 mm 	SAMII	06-04-406	06-04-406T	200 mm / 8"
		06-04-416	06-04-416T	230 mm / 9"
1/1 5 mm 	SAMII	06-04-408	06-04-418T	200 mm / 8"
		06-04-418	06-04-418T	230 mm / 9"

1/1
 SAMII
 06-04-405
 200 mm
 8"

TITAN

Artikel-Nr. Cat. No.	Artikel-Nr. Cat. No.	Gesamtlänge Total length		
06-04-851	06-04-851T	200 mm / 8"	SAMII	1/1 ø 1,5 mm 
06-04-861	06-04-861T	230 mm / 9"		
06-04-854	06-04-854T	200 mm / 8"	SAMII	1/1 ø 3 mm 
06-04-864	06-04-864T	230 mm / 9"		
06-04-856	06-04-856T	200 mm / 8"	SAMII	1/1 ø 4,5 mm 
06-04-866	06-04-866T	230 mm / 9"		
06-04-858	06-04-858T	200 mm / 8"	SAMII	1/1 ø 6 mm 
06-04-868	06-04-868T	230 mm / 9"		
06-04-298	06-04-298T	230 mm / 9" Lanzettenmesser lancet knife	SAMII	1/1 1,8 mm 
06-04-299	06-04-299T	230 mm / 9" Lanzettenmesser lancet knife	SAMII	1/1 2,5 mm 
06-04-427	06-04-427T	230 mm / 9" Mikro-Lanzettenmesser, biegsam, für Akustikus- neurinom micro lancet knife, mallea- ble for acoustic neurinoma	OPPEL	1/1 2 mm 





1/1
SAMII
06-04-864
230 mm
9"



		Artikel-Nr. Cat. No.	Gesamtlänge Total length
1/1	KOOS	06-04-351	185 mm / 7¼" spitz, aufwärts gebogen <i>pointed, curved up</i>
1/1	KOOS	06-04-352	185 mm / 7¼" spitz, abwärts gebogen <i>pointed, curved down</i>
1/1	KOOS	06-04-353	185 mm / 7¼" spitz, aufwärts gebogen <i>pointed, curved up</i>
1/1	KOOS	06-04-354	185 mm / 7¼" spitz, abwärts gebogen <i>pointed, curved down</i>
1/1	KOOS	06-04-357	185 mm / 7¼" stumpf, aufwärts gebogen <i>blunt, curved up</i>
1/1	KOOS	06-04-356	185 mm / 7¼" stumpf, abwärts gebogen <i>blunt, curved down</i>
1/1	YASARGIL	06-04-366	185 mm / 7¼" stumpf, aufwärts gebogen <i>blunt, curved up</i>
1/1	YASARGIL	06-04-365	185 mm / 7¼" stumpf, abwärts gebogen <i>blunt, curved down</i>
1/1	JACOBSON	06-04-350	185 mm / 7¼" Mikro-Gefäßmesser <i>micro vessel knife</i>

1/1
KOOS
06-04-352
 185 mm
 7¼"

Artikel-Nr. Cat. No.	Gesamtlänge Total length		
06-04-315	185 mm / 7¼"	JACOBSON	1/1 
06-06-309	230 mm / 9"	CASPAR	1/1 



1/1
CASPAR
06-06-309
230 mm
9"



1/1
OKONEK-YASARGIL
06-04-380
 230 mm
 9"





		Artikel-Nr. Cat. No.	Gesamtlänge Total length
1/1 3 mm		06-04-380	230 mm / 9"
1/1 4 mm		06-04-381	230 mm / 9"
1/1 5 mm		06-04-382	230 mm / 9"
1/1 8 mm		06-04-384	230 mm / 9"
1/1 5 mm		YASARGIL 06-04-385	220 mm / 8 ³ / ₄ "
1/1 8 mm		YASARGIL 06-04-388	200 mm / 8"

Artikel-Nr. Cat. No.	Gesamtlänge Total length	
06-04-392	185 mm / 7¼"	1/1 1,8 mm
	mit Schutzkappe with guard	

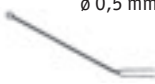

1/1
06-04-392
185 mm
7¼"

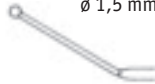

			Artikel-Nr. Cat. No.	Gesamtlänge Total length
	2/1	BIEMER	06-04-310	160 mm / 6¼"
				Gefäßspreizer <i>vessel spreader</i>
	1/1 ø 0,5 mm		06-04-306	125 mm / 5"
				Gefäßdilator <i>vessel dilator</i>
	1/1 ø 1 mm		06-04-307	125 mm / 5"
				Gefäßdilator <i>vessel dilator</i>
	1/1 ø 1,5 mm		06-04-308	125 mm / 5"
				Gefäßdilator <i>vessel dilator</i>
	1/1	JACOBSON	06-04-311	185 mm / 7¼"
				Knopfsonde <i>probe with ball tip</i>
	1/1	JACOBSON	06-04-312	185 mm / 7¼"
				Doppelsonde <i>vessel probe</i>

1/1
BIEMER
06-04-310
160 mm
6¼"

Artikel-Nr. Cat. No.	Gesamtlänge Total length		
06-06-701	220 mm / 8¾"	gerade straight	LOVE

1/2
LOVE
06-06-701
220 mm
8¾"



Artikel-Nr. Cat. No.	Gesamtlänge Total length		
06-06-702	220 mm / 8¾"	45° gewinkelt 45° angled	LOVE

1/2
LOVE
06-06-702
220 mm
8¾"

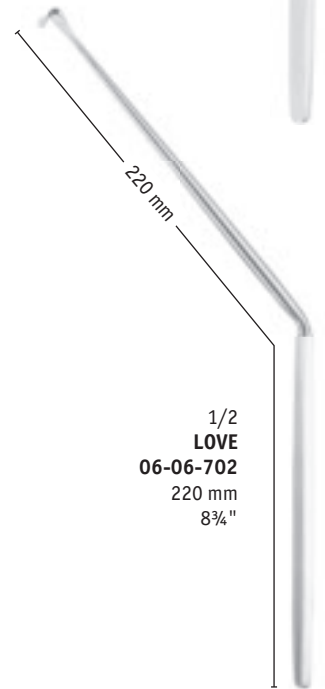

Artikel-Nr. Cat. No.	Gesamtlänge Total length		
06-06-703	220 mm / 8¾"	90° gewinkelt 90° angled	LOVE

1/2
LOVE
06-06-703
220 mm
8¾"

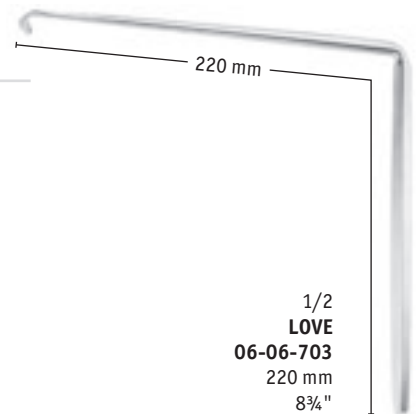



1/2
LOVE
06-06-700
210 mm
8¼"

		Artikel-Nr. Cat. No.	Gesamtlänge Total length
	LOVE	06-06-700	210 mm / 8¼"



1/2
CASPAR
06-06-710
240 mm
9½"

		Artikel-Nr. Cat. No.	Gesamtlänge Total length
	CASPAR	06-06-697	240 mm / 9½"
		06-06-699	Breite 4 mm width 4 mm 240 mm / 9½"
		06-06-710	Breite 6 mm width 6 mm 240 mm / 9½"
		06-06-698	Breite 8 mm width 8 mm 240 mm / 9½"
			Breite 10 mm width 10 mm 240 mm / 9½"

Artikel-Nr. Cat. No.	Gesamtlänge Total length		
02-20-082	190 mm / 7½"	CUSHING	1/1
02-70-084	280 mm / 11"		
02-20-083	190 mm / 7½"	CUSHING	1/1
02-20-084	280 mm / 11"		



1/2
CUSHING
02-20-083
190 mm
7½"

Artikel-Nr. Cat. No.	Gesamtlänge Total length		
06-04-394	200 mm / 8"	ADSON	1/1
stumpf blunt			
06-04-395	200 mm / 8"	ADSON	1/1
scharf sharp			



1/2
ADSON
06-04-394
200 mm
8"



1/3
HOLSHER
06-56-680
 250 mm
 10"

		Artikel-Nr. Cat. No.	Gesamtlänge Total length
1/1 7 mm	HOLSHER	06-56-680	250 mm / 10"

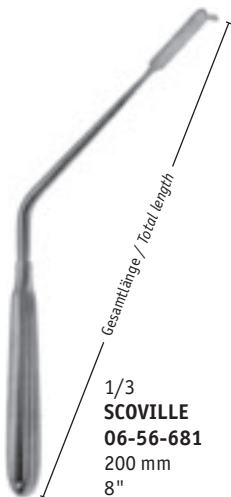



1/3
SCOVILLE
06-56-681
 200 mm
 8"

		Artikel-Nr. Cat. No.	Gesamtlänge Total length
1/1	SCOVILLE	06-56-681	200 mm / 8"



1/3
SCOVILLE
06-56-682
 230 mm
 9"

		Artikel-Nr. Cat. No.	Gesamtlänge Total length
1/1	SCOVILLE	06-56-682	230 mm / 9"

Artikel-Nr. Cat. No.	Gesamtlänge Total length		
06-06-707	175 mm / 7"	HESS	1/1 3 mm 
06-06-708	175 mm / 7"	HESS	1/1 5 mm 
06-06-709	175 mm / 7"	HESS	1/1 7 mm 









1/2
HESS
06-06-707
175 mm
7"

Artikel-Nr. Cat. No.	Gesamtlänge Total length		
06-06-730	220 mm / 8 3/4" doppellendig double-ended	O'CONNELL	1/1 



1/2
O'CONNELL
06-06-730
220 mm
8 3/4"

 1/1
06-54-510
 180 mm
 7"









	Artikel-Nr. Cat. No.	Gesamtlänge Total length
1/1 	06-54-510	180 mm / 7" gerade, vertikal <i>straight, vertical</i>
1/1 	06-54-511	180 mm / 7" gerade, horizontal <i>straight, horizontal</i>
1/1 	06-54-512	180 mm / 7" aufgebogen, vertikal <i>angled up, vertical</i>
1/1 	06-54-513	180 mm / 7" aufgebogen, horizontal <i>angled up, horizontal</i>
1/1 	06-54-514	180 mm / 7" rechts gebogen <i>curved right</i>
1/1 	06-54-515	180 mm / 7" links gebogen <i>curved left</i>

Artikel-Nr. Cat. No.	Gesamtlänge Total length	
06-54-500	180 mm / 7"	1/1 
06-54-501	180 mm / 7"	1/1 
06-54-502	180 mm / 7"	1/1 
06-54-503	180 mm / 7"	1/1 
06-54-504	180 mm / 7"	1/1 
06-54-505	180 mm / 7"	1/1 
06-54-506	180 mm / 7"	1/1 



1/1
06-54-500
 180 mm
 7"

 1/1
06-54-530
 180 mm
 7"





	Artikel-Nr. Cat. No.	Gesamtlänge Total length
1/1 	06-54-530	180 mm / 7" gerieft, gerade <i>serrated, straight</i>
1/1 	06-54-531	180 mm / 7" gerieft, aufgebogen <i>serrated, angled up</i>
1/1 	06-54-532	180 mm / 7" gerieft, rechts gebogen <i>serrated, curved right</i>
1/1 	06-54-533	180 mm / 7" gerieft, links gebogen <i>serrated, curved left</i>
1/1 	06-54-534	180 mm / 7" Alligator, gerade <i>alligator, straight</i>
1/1 	06-54-536	180 mm / 7" Alligator, rechts gebogen <i>alligator, curved right</i>
1/1 	06-54-537	180 mm / 7" Alligator, links gebogen <i>alligator, curved left</i>
1/1 	06-54-538	180 mm / 7" 1 x 2 Zähne, gerade <i>1 x 2 teeth, straight</i>

Artikel-Nr. Cat. No.	Gesamtlänge Total length	
06-54-520	180 mm / 7"	1/1 
06-54-521	180 mm / 7"	1/1 
06-54-522	180 mm / 7"	1/1 
06-54-523	180 mm / 7"	1/1 
06-54-524	180 mm / 7"	1/1 
06-54-525	180 mm / 7"	1/1 
06-54-526	180 mm / 7"	1/1 
06-54-527	180 mm / 7"	1/1 
06-54-528	180 mm / 7"	1/1 







1/1
06-54-520
 180 mm
 7"



	ø 1 mm rund round ◦	oval oval ○	Gesamtlänge Total length
1/1 	06-54-560	06-54-564	180 mm / 7" gerade straight
1/1 	06-54-561	06-54-565	180 mm / 7" aufgebogen angled up
1/1 	06-54-562	06-54-566	180 mm / 7" rechts gebogen curved right
1/1 	06-54-563	06-54-567	180 mm / 7" links gebogen curved left

1/1
06-54-560
 180 mm
 7"

ø 1 mm rund round ○	ø 1,5 mm rund round ○	ø 2 mm rund round ○	ø 2,5 mm rund round ○	oval oval ○	Gesamtlänge Total length	
06-54-540	06-54-544	06-54-548	06-54-552	06-54-556	180 mm / 7"	1/1 gerade straight 
06-54-541	06-54-545	06-54-549	06-54-553	06-54-557	180 mm / 7"	1/1 aufgebogen angled up 
06-54-542	06-54-546	06-54-550	06-54-554	06-54-558	180 mm / 7"	1/1 rechts gebogen curved right 
06-54-543	06-54-547	06-54-551	06-54-555	06-54-559	180 mm / 7"	1/1 links gebogen curved left 



1/1
06-54-540
 180 mm
 7"



		Artikel-Nr. Cat. No.	Schaftlänge Length of shaft
1/1		06-54-600	230 mm / 9" gerade, vertikal straight, vertical
1/1		06-54-601	230 mm / 9" gerade, horizontal straight, horizontal
1/1		06-54-602	230 mm / 9" aufgebogen, vertikal angled up, vertical
1/1		06-54-603	230 mm / 9" aufgebogen, horizontal angled up, horizontal
1/1		06-54-604	230 mm / 9" rechts gebogen curved right
1/1		06-54-605	230 mm / 9" links gebogen curved left
1/1	OPPEL 	06-04-420	150 mm / 6" gerade, vertikal, für Akustikusneurinom straight, vertical, for acoustic neuroma

1/2
06-54-600
230 mm
9"

Artikel-Nr. Cat. No.	Schaftlänge Length of shaft	
06-54-630	230 mm / 9"	1/1 
06-54-631	230 mm / 9"	1/1 
06-54-632	230 mm / 9"	1/1 
06-54-633	230 mm / 9"	1/1 
06-54-634	230 mm / 9"	1/1 
06-54-635	230 mm / 9"	1/1 
06-54-636	230 mm / 9"	1/1 



1/2
06-54-630
 230 mm
 9"



		Artikel-Nr. Cat. No.	Schaftlänge Length of shaft
1/1		06-54-606	230 mm / 9" gerieft, gerade serrated, straight
1/1		06-54-607	230 mm / 9" gerieft, aufgebogen serrated, angled up
1/1		06-54-608	230 mm / 9" gerieft, rechts gebogen serrated, curved right
1/1		06-54-609	230 mm / 9" gerieft, links gebogen serrated, curved left
1/1		06-54-610	230 mm / 9" Alligator, gerade alligator, straight
1/1		06-54-611	230 mm / 9" Alligator, aufgebogen alligator, angled up
1/1		06-54-612	230 mm / 9" Alligator, rechts aufgebogen alligator, curved right
1/1		06-54-613	230 mm / 9" Alligator, links aufgebogen alligator, curved left
1/1		06-54-614	230 mm / 9" Herzform, aufgebogen, 45° rechts heart shaped, angled up, 45° right
1/1		06-54-615	230 mm / 9" Herzform, aufgebogen, 45° links heart shaped, angled up, 45° left
1/1		OPPEL 06-04-423	150 mm / 6" gerieft, gerade, für Akustikneurinom serrated, straight, for acoustic neurinoma

1/2
 06-54-606
 230 mm
 9"

Artikel-Nr. Cat. No.	Schaftlänge Length of shaft	
06-54-637	230 mm / 9"	1/1 
06-54-638	230 mm / 9"	1/1 
06-54-639	230 mm / 9"	1/1 
06-54-640	230 mm / 9"	1/1 
06-54-641	230 mm / 9"	1/1 
06-54-642	230 mm / 9"	1/1 
06-54-643	230 mm / 9"	1/1 
06-54-644	230 mm / 9"	1/1 
06-54-645	230 mm / 9"	1/1 
06-54-646	230 mm / 9"	1/1 
06-54-647	230 mm / 9"	1/1 
06-54-648	230 mm / 9"	1/1 



1/2
06-54-637
 230 mm
 9"



		Artikel-Nr. Cat. No.	Schaftlänge Length of shaft
1/1 ø 1 mm 		06-54-616	230 mm / 9" gerade straight
1/1 ø 1 mm 		06-54-617	230 mm / 9" aufgebogen angled up
1/1 ø 1 mm 		06-54-618	230 mm / 9" rechts gebogen curved right
1/1 ø 1 mm 		06-54-619	230 mm / 9" links gebogen curved left
1/1 ø 1 mm 		06-54-620	230 mm / 9" aufgebogen, 45° rechts angled up, 45° right
1/1 ø 1 mm 		06-54-621	230 mm / 9" aufgebogen, 45° links angled up, 45° left
1/1 ø 1 mm, oval 		06-54-622	230 mm / 9" gerade straight
1/1 ø 1 mm, oval 		06-54-623	230 mm / 9" aufgebogen angled up
1/1 ø 1 mm, oval 		06-54-624	230 mm / 9" rechts gebogen curved right
1/1 ø 1 mm, oval 		06-54-625	230 mm / 9" links gebogen curved left
1/1 ø 1 mm, oval 	OPPEL	06-04-426	150 mm / 6" gerade, für Akustikusneurinom straight, for acoustic neurinoma

1/2
06-54-617
230 mm
9"

Artikel-Nr. Cat. No.	Schaftlänge Length of shaft	
06-54-649	230 mm / 9"	1/1 2,5 mm 
06-54-650	230 mm / 9"	1/1 2,5 mm 
06-54-651	230 mm / 9"	1/1 2,5 mm 
06-54-652	230 mm / 9"	1/1 2,5 mm 
06-54-653	230 mm / 9"	1/1 2,5 mm 
06-54-654	230 mm / 9"	1/1 2,5 mm 
06-54-655	230 mm / 9"	1/1 2,5 mm 



1/2
06-54-650
 230 mm
 9"

 1/2
06-54-657
 230 mm
 9"

	Artikel-Nr. Cat. No.	Schaftlänge Length of shaft
1/1 \emptyset 2,5 x 4 mm 	06-54-656	230 mm / 9" gerade <i>straight</i>
1/1 \emptyset 2,5 x 4 mm 	06-54-657	230 mm / 9" aufgebogen 45° <i>angled up 45°</i>
1/1 \emptyset 2,5 x 4 mm 	06-54-658	230 mm / 9" rechts gebogen <i>curved right</i>
1/1 \emptyset 2,5 x 4 mm 	06-54-659	230 mm / 9" links gebogen <i>curved left</i>
1/1 \emptyset 2,5 x 4 mm 	06-54-660	230 mm / 9" spitz, aufgebogen 45° <i>pointed, angled up 45°</i>
1/1 \emptyset 2,5 x 4 mm 	06-54-661	230 mm / 9" spitz, aufgebogen rechts öffnend <i>pointed, angled, open to right</i>
1/1 \emptyset 2,5 x 4 mm 	06-54-662	230 mm / 9" spitz, aufgebogen links öffnend <i>pointed, angled, open to left</i>
1/1 \emptyset 2,5 x 5 mm 	06-54-663	230 mm / 9" gefenstert, aufgebogen <i>fenestrated, curved up</i>

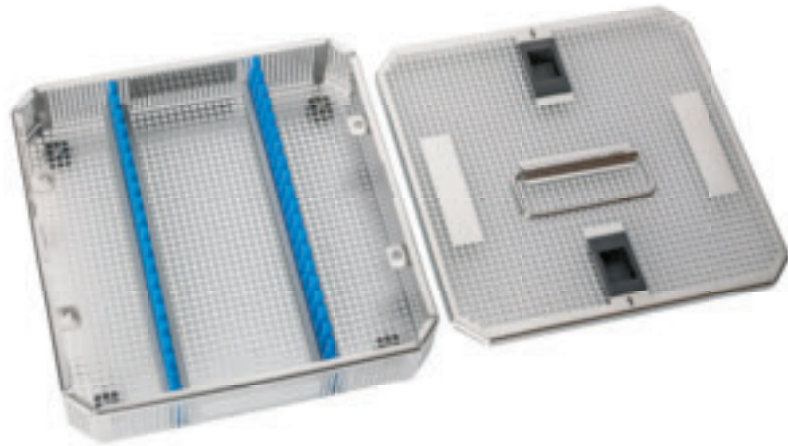

Artikel-Nr.
Cat. No.

Gesamtlänge
Total length

10-56-024

243 x 253 x 50 mm

Siebkorb aus Edelstahlblech mit Deckel und
Silikonhalterungen für Rhoton-Instrumente
und feine Mikro-Instrumente

*stainless steel basket with lid and silicone
fixation system for Rhoton instruments and
fine micro instruments*

Artikel-Nr.
Cat. No.

Sterilisier-Container aus Edelstahl mit Deckel- und Bodenlochung, Langzeittextilfilter für Dampfsterilisation, Silikon-Andruckleiste im Deckel, mit 1 Siebeinsatz mit Silikon-Fixationssystem zur Lagerung von Mikro-Instrumenten

Sterilization Container, stainless steel, lid and bottom perforated, long-life textile filter for steam sterilisation, silicone stripes in the lid, with 1 tray insert with silicone fixation system for micro instruments

Maße
Measurements

10-56-010	200 x 140 x 50 mm
10-56-011	280 x 200 x 50 mm
10-56-012	270 x 260 x 50 mm
10-56-013	380 x 260 x 50 mm



Artikel-Nr.
Cat. No.

	<p>Sterilisier-Container aus Edelstahl mit Deckel- und Bodenlochung, Langzeittextilfilter für Dampfsterilisation, Silikon-Andruckleiste im Deckel, mit 2 Siebeinsätzen mit Silikon-Fixationssystem zur Lagerung von Mikro-Instrumenten</p> <p><i>Sterilization Container, stainless steel, lid and bottom perforated, long-life textile filter for steam sterilisation, silicone stripes in the lid, with 2 trays insert with silicone fixation system for micro instruments</i></p> <p style="text-align: center;">Maße Measurements</p>
10-56-020	200 x 140 x 60 mm
10-56-021	280 x 200 x 60 mm
10-56-022	270 x 260 x 60 mm
10-56-023	380 x 260 x 60 mm

01

Mikro-Neurochirurgische Instrumente
Micro-Neurosurgical Instruments

HF-Instrumente und Zubehör
HF Instruments and Accessoires

03

Kopf-Schädelinstrumente und Haltesysteme
Head-Cranio Instruments and Holding Systems

04

Aneurysmen-Clip System
Aneurysm Clip System

05

Schädel-Verplattung
Cranial Plate System

06

Hypophysektomie-Instrumente
Pituitary Instruments

07

Instrumente für die Wirbelsäule, Wundspreizer
Spine Instruments, Self-retaining Retractors

08

Laminektomie-Stanzen, Rongeuere, Hohlmeißelzangen
Laminectomy Punches, Rongeurs

09

Gefäß- und Bulldogklemmen, Gefäß-Clips
Vessel- and Bulldog-Clamps, Vessel Clips

10

Allgemeinchirurgische Instrumente
General Surgical Instruments

11

Alphabetischer Index, Numerischer Index
Alphabetical Index, Numerical Index

/// 02



SURGICAL
INSTRUMENTS
MICRO-NEURO-SPINE

REBSTOCK®
Precision made in Germany

/// HF-Instrumente und Zubehör
HF Instruments and Accessoires

/// www.rebstock.de



Bipolare Pinzette Standard
Bipolare Forceps Standard

Beispiel-Artikel-Nr. **07-11-920**
Example Cat. No.



Spezialbeschichtete Edelmetallspitzen verhindern das Verkleben mit koagulierte[m] Gewebe

Special coated noble metal tips prevent from sticking with coagulated tissue



Bipolare Pinzette NON-STICK
Bipolare Forceps NON-STICK

Beispiel-Artikel-Nr. **07-11-920N**
Example Cat. No.

NON-STICK



NON-STICK

Artikel-Nr. Cat. No.	Artikel-Nr. Cat. No.	Gesamtlänge Total length		
07-61-904	07-61-904N	110 mm / 4 $\frac{3}{4}$ "	JEWELER	1/1 0,25 mm 
07-61-905	07-61-905N	110 mm / 4 $\frac{3}{4}$ "	JEWELER	1/1 0,5 mm 

1/1
JEWELER
07-61-904
110 mm
4 $\frac{3}{4}$ "



NON-STICK





Artikel-Nr. Cat. No.	Artikel-Nr. Cat. No.	Gesamtlänge Total length		
07-61-906	07-61-906N	110 mm / 4 $\frac{3}{4}$ "	JEWELER	1/1 0,25 mm 
07-61-907	07-61-907N	110 mm / 4 $\frac{3}{4}$ "	JEWELER	1/1 0,5 mm 

1/1
JEWELER
07-61-907
110 mm
4 $\frac{3}{4}$ "









1/1
07-61-916
 180 mm
 7"

		NON-STICK		
	Artikel-Nr. Cat. No.	Artikel-Nr. Cat. No.		Gesamtlänge Total length
1/1 0,3 mm 	07-61-910	07-61-910N		160 mm / 6 $\frac{1}{8}$ "
	07-61-911	07-61-911N		180 mm / 7"
	07-61-912	07-61-912N		195 mm / 7 $\frac{3}{4}$ "
	07-61-913	07-61-913N		220 mm / 8 $\frac{3}{4}$ "
	07-61-914	07-61-914N		240 mm / 9 $\frac{1}{2}$ "
1/1 0,5 mm 	07-61-801	07-61-801N		160 mm / 6 $\frac{1}{8}$ "
	07-61-802	07-61-802N		180 mm / 7"
	07-61-803	07-61-803N		195 mm / 7 $\frac{3}{4}$ "
	07-61-804	07-61-804N		220 mm / 8 $\frac{3}{4}$ "
	07-61-805	07-61-805N		240 mm / 9 $\frac{1}{2}$ "
1/1 1 mm 	07-61-915	07-61-915N		160 mm / 6 $\frac{1}{8}$ "
	07-61-916	07-61-916N		180 mm / 7"
	07-61-917	07-61-917N		195 mm / 7 $\frac{3}{4}$ "
	07-61-918	07-61-918N		220 mm / 8 $\frac{3}{4}$ "
	07-61-919	07-61-919N		240 mm / 9 $\frac{1}{2}$ "
1/1 2 mm 	07-61-920	07-61-920N		160 mm / 6 $\frac{1}{8}$ "
	07-61-921	07-61-921N		180 mm / 7"
	07-61-922	07-61-922N		195 mm / 7 $\frac{3}{4}$ "
	07-61-923	07-61-923N		220 mm / 8 $\frac{3}{4}$ "
	07-61-924	07-61-924N		240 mm / 9 $\frac{1}{2}$ "

NON-STICK





Artikel-Nr. Cat. No.	Artikel-Nr. Cat. No.	Gesamtlänge Total length	
07-61-925	07-61-925N	160 mm / 6 $\frac{1}{8}$ "	1/1 0,3 mm
07-61-926	07-61-926N	180 mm / 7"	
07-61-927	07-61-927N	195 mm / 7 $\frac{3}{4}$ "	
07-61-928	07-61-928N	220 mm / 8 $\frac{3}{4}$ "	
07-61-929	07-61-929N	240 mm / 9 $\frac{1}{2}$ "	
07-61-811	07-61-811N	160 mm / 6 $\frac{1}{8}$ "	1/1 0,5 mm
07-61-812	07-61-812N	180 mm / 7"	
07-61-813	07-61-813N	195 mm / 7 $\frac{3}{4}$ "	
07-61-814	07-61-814N	220 mm / 8 $\frac{3}{4}$ "	
07-61-815	07-61-815N	240 mm / 9 $\frac{1}{2}$ "	
07-61-930	07-61-930N	160 mm / 6 $\frac{1}{8}$ "	1/1 1 mm
07-61-931	07-61-931N	180 mm / 7"	
07-61-932	07-61-932N	195 mm / 7 $\frac{3}{4}$ "	
07-61-933	07-61-933N	220 mm / 8 $\frac{3}{4}$ "	
07-61-934	07-61-934N	240 mm / 9 $\frac{1}{2}$ "	
07-61-935	07-61-935N	160 mm / 6 $\frac{1}{8}$ "	1/1 2 mm
07-61-936	07-61-936N	180 mm / 7"	
07-61-937	07-61-937N	195 mm / 7 $\frac{3}{4}$ "	
07-61-938	07-61-938N	220 mm / 8 $\frac{3}{4}$ "	
07-61-939	07-61-939N	240 mm / 9 $\frac{1}{2}$ "	







1/1
07-61-931
180 mm
7"



1/1
07-61-940
 165 mm
 6½"

	Artikel-Nr. Cat. No.	NON-STICK Artikel-Nr. Cat. No.	Gesamtlänge Total length
1/1 0,3 mm 	07-61-940	07-61-940N	165 mm / 6½"
1/1 0,5 mm 	07-61-816	07-61-816N	165 mm / 6½"
1/1 1 mm 	07-61-941	07-61-941N	165 mm / 6½"
1/1 2 mm 	07-61-942	07-61-942N	165 mm / 6½"

NON-STICK

Artikel-Nr. Cat. No.	Artikel-Nr. Cat. No.	Gesamtlänge Total length	
07-11-899	07-11-899N	160 mm / 6 $\frac{1}{6}$ "	1/1 0,3 mm
07-61-943	07-61-943N	180 mm / 7"	
07-11-929	07-11-929N	195 mm / 7 $\frac{3}{4}$ "	
07-11-959	07-11-959N	220 mm / 8 $\frac{3}{4}$ "	
07-61-944	07-61-944N	240 mm / 9 $\frac{1}{2}$ "	
07-11-900	07-11-900N	160 mm / 6 $\frac{1}{6}$ "	1/1 0,5 mm
07-61-817	07-61-817N	180 mm / 7"	
07-11-930	07-11-930N	195 mm / 7 $\frac{3}{4}$ "	
07-11-960	07-11-960N	220 mm / 8 $\frac{3}{4}$ "	
07-61-818	07-61-818N	240 mm / 9 $\frac{1}{2}$ "	
07-11-910	07-11-910N	160 mm / 6 $\frac{1}{6}$ "	1/1 1 mm
07-61-945	07-61-945N	180 mm / 7"	
07-11-940	07-11-940N	195 mm / 7 $\frac{3}{4}$ "	
07-11-970	07-11-970N	220 mm / 8 $\frac{3}{4}$ "	
07-61-946	07-61-946N	240 mm / 9 $\frac{1}{2}$ "	
07-11-920	07-11-920N	160 mm / 6 $\frac{1}{6}$ "	1/1 2 mm
07-61-947	07-61-947N	180 mm / 7"	
07-11-950	07-11-950N	195 mm / 7 $\frac{3}{4}$ "	
07-11-980	07-11-980N	220 mm / 8 $\frac{3}{4}$ "	
07-61-948	07-61-948N	240 mm / 9 $\frac{1}{2}$ "	



1/1
07-11-940
195 mm
7 $\frac{3}{4}$ "







1/1
07-61-965
 195 mm
 7¾"

NON-STICK

	Artikel-Nr. Cat. No.	Artikel-Nr. Cat. No.	Gesamtlänge Total length
1/1 0,3 mm 	07-61-840	07-61-840N	160 mm / 6½"
	07-61-960	07-61-960N	180 mm / 7"
	07-61-961	07-61-961N	195 mm / 7¾"
	07-61-962	07-61-962N	220 mm / 8¾"
	07-61-963	07-61-963N	240 mm / 9½"
			abwärts gewinkelt angled down
1/1 0,5 mm 	07-61-841	07-61-841N	160 mm / 6½"
	07-61-842	07-61-842N	180 mm / 7"
	07-61-843	07-61-843N	195 mm / 7¾"
	07-61-844	07-61-844N	220 mm / 8¾"
	07-61-845	07-61-845N	240 mm / 9½"
			abwärts gewinkelt angled down
1/1 1 mm 	07-61-846	07-61-846N	160 mm / 6½"
	07-61-964	07-61-964N	180 mm / 7"
	07-61-965	07-61-965N	195 mm / 7¾"
	07-11-972	07-11-972N	220 mm / 8¾"
	07-61-966	07-61-966N	240 mm / 9½"
			abwärts gewinkelt angled down
1/1 2 mm 	07-61-847	07-61-847N	160 mm / 6½"
	07-61-967	07-61-967N	180 mm / 7"
	07-61-968	07-61-968N	195 mm / 7¾"
	07-61-969	07-61-969N	220 mm / 8¾"
	07-61-970	07-61-970N	240 mm / 9½"
			abwärts gewinkelt angled down





NON-STICK

Artikel-Nr. Cat. No.	Artikel-Nr. Cat. No.	Gesamtlänge Total length	
07-61-830	07-61-830N	160 mm / 6 $\frac{1}{6}$ "	1/1 0,3 mm
07-61-949	07-61-949N	180 mm / 7"	
07-61-950	07-61-950N	195 mm / 7 $\frac{3}{4}$ "	
07-61-951	07-61-951N	220 mm / 8 $\frac{3}{4}$ "	
07-61-952	07-61-952N	240 mm / 9 $\frac{1}{2}$ "	
		aufwärts gewinkelt angled up	
07-61-831	07-61-831N	160 mm / 6 $\frac{1}{6}$ "	1/1 0,5 mm
07-61-832	07-61-832N	180 mm / 7"	
07-61-833	07-61-833N	195 mm / 7 $\frac{3}{4}$ "	
07-61-834	07-61-834N	220 mm / 8 $\frac{3}{4}$ "	
07-61-835	07-61-835N	240 mm / 9 $\frac{1}{2}$ "	
		aufwärts gewinkelt angled up	
07-61-836	07-61-836N	160 mm / 6 $\frac{1}{6}$ "	1/1 1 mm
07-61-953	07-61-953N	180 mm / 7"	
07-61-954	07-61-954N	195 mm / 7 $\frac{3}{4}$ "	
07-11-974	07-11-974N	220 mm / 8 $\frac{3}{4}$ "	
07-61-955	07-61-955N	240 mm / 9 $\frac{1}{2}$ "	
		aufwärts gewinkelt angled up	
07-61-837	07-61-837N	160 mm / 6 $\frac{1}{6}$ "	1/1 2 mm
07-61-956	07-61-956N	180 mm / 7"	
07-61-957	07-61-957N	195 mm / 7 $\frac{3}{4}$ "	
07-61-958	07-61-958N	220 mm / 8 $\frac{3}{4}$ "	
07-61-959	07-61-959N	240 mm / 9 $\frac{1}{2}$ "	
		aufwärts gewinkelt angled up	







1/1
07-61-954
195 mm
7 $\frac{3}{4}$ "

NON-STICK

	Artikel-Nr. Cat. No.	Artikel-Nr. Cat. No.	Gesamtlänge Total length
1/1 0,3 mm 	07-61-806	07-61-806N	160 mm / 6 $\frac{1}{8}$ "
	07-61-807	07-61-807N	180 mm / 7"
	07-61-808	07-61-808N	195 mm / 7 $\frac{3}{4}$ "
	07-61-809	07-61-809N	220 mm / 8 $\frac{3}{4}$ "
	07-61-810	07-61-810N	240 mm / 9 $\frac{1}{2}$ "
			breiter Griff wide handle
1/1 0,5 mm 	07-61-850	07-61-850N	160 mm / 6 $\frac{1}{8}$ "
	07-61-860	07-61-860N	180 mm / 7"
	07-61-861	07-61-861N	195 mm / 7 $\frac{3}{4}$ "
	07-61-862	07-61-862N	220 mm / 8 $\frac{3}{4}$ "
	07-61-851	07-61-851N	240 mm / 9 $\frac{1}{2}$ "
			breiter Griff wide handle
1/1 1 mm 	07-61-852	07-61-852N	160 mm / 6 $\frac{1}{8}$ "
	07-61-863	07-61-863N	180 mm / 7"
	07-61-864	07-61-864N	195 mm / 7 $\frac{3}{4}$ "
	07-61-865	07-61-865N	220 mm / 8 $\frac{3}{4}$ "
	07-61-853	07-61-853N	240 mm / 9 $\frac{1}{2}$ "
			breiter Griff wide handle
1/1 2 mm 	07-61-854	07-61-854N	160 mm / 6 $\frac{1}{8}$ "
	07-61-866	07-61-866N	180 mm / 7"
	07-61-867	07-61-867N	195 mm / 7 $\frac{3}{4}$ "
	07-61-868	07-61-868N	220 mm / 8 $\frac{3}{4}$ "
	07-61-855	07-61-855N	240 mm / 9 $\frac{1}{2}$ "
			breiter Griff wide handle

1/1
07-61-864
 195 mm
 7 $\frac{3}{4}$ "

NON-STICK

Artikel-Nr. Cat. No.	Artikel-Nr. Cat. No.	Gesamtlänge Total length	
07-61-819	07-61-819N	170 mm / 6¾"	1/1 0,3 mm
07-61-820	07-61-820N	200 mm / 8"	
07-61-821	07-61-821N	220 mm / 8¾"	
07-61-822	07-61-822N	230 mm / 9"	
07-61-823	07-61-823N	250 mm / 10"	
		breiter Griff wide handle	
07-61-824	07-61-824N	170 mm / 6¾"	1/1 0,5 mm
07-61-870	07-61-870N	200 mm / 8"	
07-61-871	07-61-871N	220 mm / 8¾"	
07-61-872	07-61-872N	230 mm / 9"	
07-61-873	07-61-873N	250 mm / 10"	
		breiter Griff wide handle	
07-61-825	07-61-825N	170 mm / 6¾"	1/1 1 mm
07-61-874	07-61-874N	200 mm / 8"	
07-61-875	07-61-875N	220 mm / 8¾"	
07-61-876	07-61-876N	230 mm / 9"	
07-61-877	07-61-877N	250 mm / 10"	
		breiter Griff wide handle	
07-61-826	07-61-826N	170 mm / 6¾"	1/1 2 mm
07-61-878	07-61-878N	200 mm / 8"	
07-61-879	07-61-879N	220 mm / 8¾"	
07-61-880	07-61-880N	230 mm / 9"	
07-61-881	07-61-881N	250 mm / 10"	
		breiter Griff wide handle	



1/1
07-61-878
 200 mm
 8"

Alle REBSTOCK monopolaren Pinzetten sind mit den folgenden Buchsen erhältlich:
 All REBSTOCK monopolar forceps are available with the following plugs:



	Artikel-Nr. Cat. No.	Durchmesser Diameter
	07-61-705	ø 4,0 mm Buchse mit männlichem Anschluss, geschützt <i>plug with male connector, protected</i>
	07-61-706	ø 4,0 mm Buchse mit männlichem Anschluss <i>plug with male connector</i>
	07-61-707	ø 4,0 mm Buchse mit weiblichem Anschluss, geschützt <i>plug with female connector, protected</i>

Abbildungsbeispiel / Example:
 Monopolare Pinzette mit integrierter Buchse
monopolar forceps with integrated plug
07-61-704 + 07-61-706

Artikel-Nr. Cat. No.	Gesamtlänge Total length	
07-61-700	140 mm / 5½"	1/1
07-61-701	180 mm / 7"	
07-61-702	210 mm / 8¼"	
07-61-703	250 mm / 10"	
07-61-704	300 mm / 12"	

Alle monopolaren Pinzetten werden serienmäßig ohne Buchse geliefert. Die Buchse ist jeweils separat zu bestellen. Hierbei bitte die Artikel-Nummer der gewünschten Ausführung von Seite 134 angeben.

All monopolar forceps are serially supplied without plug. The plug needs to be ordered separately by adding the article number of the requested model as shown on page 134.



1/1
07-61-700
140 mm
5½"



		Artikel-Nr. Cat. No.	Gesamtlänge Total length
1/1	LUCAE	07-61-720	145 mm / 5½"
1/1	JANSEN	07-61-721	160 mm / 6⅝"
1/1	GRUENWALD	07-61-722	190 mm / 7¾"

Alle monopolaren Pinzetten werden serienmäßig ohne Buchse geliefert. Die Buchse ist jeweils separat zu bestellen. Hierbei bitte die Artikel-Nummer der gewünschten Ausführung von Seite 134 angeben.

All monopolar forceps are serially supplied without plug. The plug needs to be ordered separately by adding the article number of the requested model as shown on page 134.

1/1
JANSEN
07-61-721
 160 mm
 6⅝"

Artikel-Nr. Cat. No.	Gesamtlänge Total length	
07-61-710	140 mm / 5½"	1/1
07-61-711	180 mm / 7"	
07-61-712	210 mm / 8¼"	
07-61-713	250 mm / 10"	
07-61-714	300 mm / 12"	





Alle monopolaren Pinzetten werden serienmäßig ohne Buchse geliefert. Die Buchse ist jeweils separat zu bestellen. Hierbei bitte die Artikel-Nummer der gewünschten Ausführung von Seite 134 angeben.



All monopolar forceps are serially supplied without plug. The plug needs to be ordered separately by adding the article number of the requested model as shown on page 134.





1/1
07-61-710
 140 mm
 5½"

		Stecker, geräteseitig passend für Geräte: plug, generator side for units:	Artikel-Nr. Cat. No.	Gesamtlänge Total length
Geräteseite equipment side		ERBE	07-61-980	3 m
			07-61-981	5 m
		Instrumentenseite instrument side		

		Stecker, geräteseitig passend für Geräte: plug, generator side for units:	Artikel-Nr. Cat. No.	Gesamtlänge Total length
Geräteseite equipment side		AESCULAP GK 4	07-61-982	3 m
			07-61-983	5 m
		Instrumentenseite instrument side		



		Stecker, geräteseitig passend für Geräte: plug, generator side for units:	Artikel-Nr. Cat. No.	Gesamtlänge Total length
Geräteseite equipment side		USA MOD. 2-Banannen- stecker	07-61-984	3 m
			07-61-985	5 m
		Instrumentenseite instrument side		

		Stecker, geräteseitig passend für Geräte: plug, generator side for units:	Artikel-Nr. Cat. No.	Gesamtlänge Total length
Geräteseite equipment side		MARTIN BERCHTOLD AESCULAP GK55 GK60	07-61-986	3 m
			07-61-987	5 m
		Instrumentenseite instrument side		

Artikel-Nr. Cat. No.	Gesamtlänge Total length	Stecker, geräteseitig passend für Geräte: plug, generator side for units:	
07-61-730	3 m	ERBE ACC/ICC	 <p>5 mm I</p> <p>Geräteseite equipment side</p>  <p>Instrumentenseite instrument side</p>
07-61-731	5 m		

Artikel-Nr. Cat. No.	Gesamtlänge Total length	Stecker, geräteseitig passend für Geräte: plug, generator side for units:	
07-61-732	3 m	ERBE T-MODELL	 <p>Geräteseite equipment side</p>  <p>Instrumentenseite instrument side</p>
07-61-733	5 m		

Artikel-Nr. Cat. No.	Gesamtlänge Total length	Stecker, geräteseitig passend für Geräte: plug, generator side for units:	
07-61-734	5 m	MARTIN BERCHTOLD AESCULAP	 <p>Geräteseite equipment side</p>  <p>Instrumentenseite instrument side</p>

Artikel-Nr. Cat. No.	Gesamtlänge Total length	Stecker, geräteseitig passend für Geräte: plug, generator side for units:	
07-61-735	3 m	VALLEYLAB	 <p>Geräteseite equipment side</p>  <p>Instrumentenseite instrument side</p>
07-61-736	5 m		

01

Mikro-Neurochirurgische Instrumente
Micro-Neurosurgical Instruments

02

HF-Instrumente und Zubehör
HF Instruments and Accessoires

Kopf-Schädelinstrumente und Haltesysteme
Head-Cranio Instruments and Holding Systems

04

Aneurysmen-Clip System
Aneurysm Clip System

05

Schädel-Verplattung
Cranial Plate System

06

Hypophysektomie-Instrumente
Pituitary Instruments

07

Instrumente für die Wirbelsäule, Wundspreizer
Spine Instruments, Self-retaining Retractors

08

Laminektomie-Stanzen, Rongeurs, Hohlmeißelzangen
Laminectomy Punches, Rongeurs

09

Gefäß- und Bulldogklemmen, Gefäß-Clips
Vessel- and Bulldog-Clamps, Vessel Clips

10

Allgemeinchirurgische Instrumente
General Surgical Instruments

11

Alphabetischer Index, Numerischer Index
Alphabetical Index, Numerical Index

/// 03



SURGICAL
INSTRUMENTS
MICRO-NEURO-SPINE

REBSTOCK®
Precision made in Germany



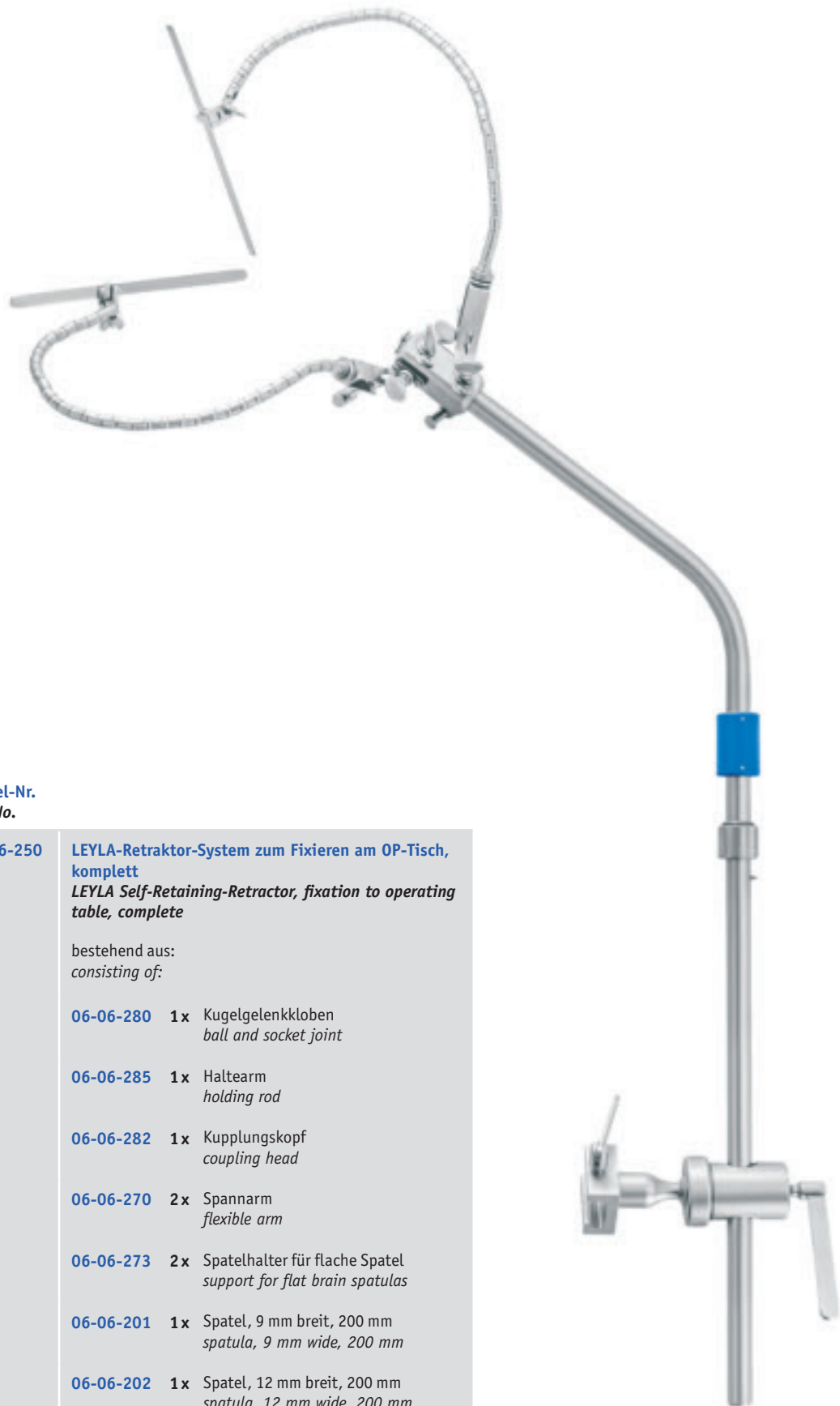

/// Kopf-Schädelinstrumente und Haltesysteme
Head-Cranio Instruments and Holding Systems

/// www.rebstock.de



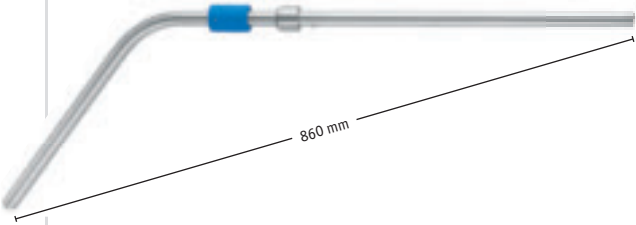

Artikel-Nr.
Cat. No.

LEYLA	06-56-250	LEYLA-Retraktor-System zum Fixieren am OP-Tisch, komplett <i>LEYLA Self-Retaining-Retractor, fixation to operating table, complete</i>
		bestehend aus: <i>consisting of:</i>
	06-06-280	1x Kugelgelenkkloben <i>ball and socket joint</i>
	06-06-285	1x Haltearm <i>holding rod</i>
	06-06-282	1x Kupplungskopf <i>coupling head</i>
	06-06-270	2x Spannarm <i>flexible arm</i>
	06-06-273	2x Spatelhalter für flache Spatel <i>support for flat brain spatulas</i>
	06-06-201	1x Spatel, 9 mm breit, 200 mm <i>spatula, 9 mm wide, 200 mm</i>
	06-06-202	1x Spatel, 12 mm breit, 200 mm <i>spatula, 12 mm wide, 200 mm</i>

Artikel-Nr.
Cat. No.

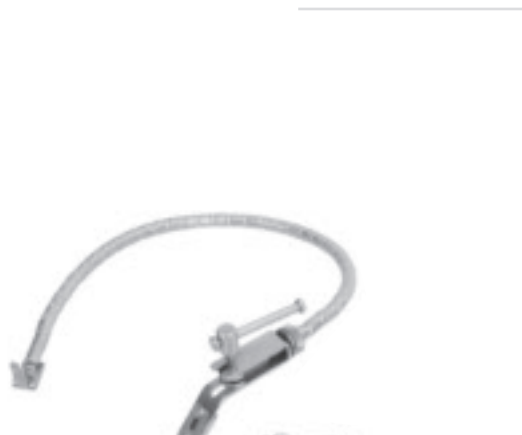
<p>06-06-280</p>	<p>Kugelgelenkkloben zum Befestigen an der OP-Tischschiene und zur Aufnahme des Haltearms 06-06-285</p> <p><i>ball and socket joint for fixing holding rod 06-06-285 to the operating table</i></p>	<p>LEYLA</p>	
<p>06-06-285</p>	<p>Haltearm, starr, 860 mm, auseinandernehmbar, zur Fixation im Kugelgelenkkloben 06-06-280 und zur wahlweisen Aufnahme der Kupplungsköpfe 06-06-282, 06-06-283 und 06-06-284</p> <p><i>holding rod, rigid, 860 mm, detachable, for fixation in ball and socket joint 06-06-280 and to hold coupling head 06-06-282, 06-06-283 and 06-06-284</i></p>	<p>LEYLA</p>	
<p>06-06-282</p>	<p>Kupplungskopf zur Aufnahme von max. 5 Spannarmen 06-06-270</p> <p><i>coupling head to hold up to 5 flexible arms 06-06-270</i></p>	<p>LEYLA</p>	
<p>06-06-283</p>	<p>Kupplungskopf, drehbar auf Haltearm, zur Aufnahme von 1 Spannarm 06-06-270</p> <p><i>coupling head, rotatable on holding rod, to hold 1 flexible arm 06-06-270</i></p>	<p>LEYLA</p>	
<p>06-06-284</p>	<p>Kupplungskopf, seitlich offen, zum Aufstecken auf Haltearm, zur Aufnahme von 1 Spannarm 06-06-270</p> <p><i>coupling head, lateral open, for mounting on holding rod, to hold 1 flexible arm 06-06-270</i></p>	<p>LEYLA</p>	

Artikel-Nr.
Cat. No.

	YASARGIL	06-06-260	LEYLA Retraktor mit flexiblem Spannarm, zur Aufnahme von 1 flachen Spatel, komplett LEYLA Retractor with flexible arm, to adapt 1 flat spatula, complete bestehend aus: <i>consisting of:</i> 06-06-267 1x Fixiervorrichtung für 1 Spannarm <i>fixation base for 1 flexible arm</i> 06-06-270 1x Spannarm <i>flexible arm</i> 06-06-273 1x Halter für flache Spatel <i>support for flat brain spatulas</i>
	YASARGIL	06-06-262	LEYLA Retraktor mit 2 flexiblen Spannarmen, zur Aufnahme von 2 flachen Spateln, komplett LEYLA Retractor with 2 flexible arms, to adapt 2 flat spatulas, complete bestehend aus: <i>consisting of:</i> 06-06-268 1x Fixiervorrichtung für 2 Spannarme <i>fixation base for 2 flexible arms</i> 06-06-270 2x Spannarm <i>flexible arm</i> 06-06-273 2x Halter für flache Spatel <i>support for flat brain spatulas</i>
		15-06-099	LEYLA Retraktor mit flexiblem Spannarm, für Ohrtrichterhalter, komplett LEYLA Retractor with flexible arm, for ear spatula holder, complete bestehend aus: <i>consisting of:</i> 06-06-266 1x Fixiervorrichtung zum Befestigen an Rohrteilen bis ø 16 mm <i>fixation base for mounting to bars up to ø 16 mm</i> 06-06-270 1x Spannarm <i>flexible arm</i> 06-06-275 1x Ohrtrichterhalter <i>ear specula holder</i>

Artikel-Nr.
 Cat. No.

<p>06-06-270</p>	<p>Flexibler Spannarm, 520 mm <i>flexible arm, 520 mm</i></p>	<p>YASARGIL</p>	
<p>06-06-273</p>	<p>Halter für flache Spatel <i>support for flat spatulas</i></p>		
<p>06-06-274</p>	<p>Halter für Spatel mit rundem Schaft <i>support for spatulas with round shaft</i></p>		
<p>06-06-268</p>	<p>Fixiervorrichtung am Schädel für 2 flexible Spannarme 06-06-270 <i>fixation base for skull mounting, holding 2 flexible arms 06-06-270</i></p>		

Artikel-Nr.
Cat. No.
**06-06-267**
 Fixiervorrichtung am Schädel, für
 1 flexiblen Spannarm 06-06-270



*fixation base for skull mounting,
 holding 1 flexible arm 06-06-270*
**06-06-266**
 Fixiervorrichtung zum Befestigen an
 Rohrteilen bis ø 16 mm, für 1 flexiblen
 Spannarm 06-06-270

*fixation base for mounting to bars
 up to ø 16 mm, for 1 flexible arm
 06-06-270*
**06-56-281**
 Universal Halterung zur Fixierung von
 3 flexiblen Spannarmen 06-06-270

*universal clamp for fixation of
 3 flexible arms 06-06-270*

TITAN

Artikel-Nr.
 Cat. No.

<p>06-06-270T</p>	<p>Flexibler Spannarm, 470 mm, TITAN <i>flexible arm, 470 mm, TITANIUM</i></p>	<p>YASARGIL</p>	
<p>06-06-268T</p>	<p>Fixiervorrichtung am Schädel für 2 flexible Spannarme 06-06-270T, TITAN <i>fixation base for skull mounting, holding 2 flexible arms 06-06-270T, TITANIUM</i></p>		
<p>06-06-273T</p>	<p>Halter für flache Spatel, TITAN <i>support for flat brain spatulas, TITANIUM</i></p>		

3



MEMORY

 1/2
MEMORY
06-56-457B
 200 mm
 8"

	Artikel-Nr. Cat. No.	Gesamtlänge Total length
MEMORY	06-56-456	200 mm / 8" 4 + 8 mm breit 4 + 8 mm wide
	06-56-457	200 mm / 8" 6 + 13 mm breit 6 + 13 mm wide
	06-56-458	200 mm / 8" 7 + 17 mm breit 7 + 17 mm wide
	06-56-459	200 mm / 8" 11 + 21 mm breit 11 + 21 mm wide
biegsam, aus spezieller MEMORY Legierung, biegt sich bei der Sterilisation automatisch in den ursprünglich geraden Zustand zurück <i>malleable, made out of special MEMORY alloy, straightens automatically during the sterilisation process</i>		



MEMORY

 1/2
MEMORY
06-56-224
 200 mm
 8"

	Artikel-Nr. Cat. No.	Gesamtlänge Total length
MEMORY	06-56-224	200 mm / 8" 9 mm breit 9 mm wide
	06-56-226	200 mm / 8" 12 mm breit 12 mm wide
	06-56-228	200 mm / 8" 14 mm breit 14 mm wide
	06-56-230	200 mm / 8" 18 mm breit 18 mm wide
	06-56-232	200 mm / 8" 20 mm breit 20 mm wide
	06-56-234	200 mm / 8" 25 mm breit 25 mm wide
biegsam, aus spezieller MEMORY-Legierung, biegt sich bei der Sterilisation automatisch in den ursprünglich geraden Zustand zurück <i>malleable, made out of special MEMORY alloy, straightens automatically during the sterilisation process</i>		

Standard Line

 Oberfläche matt gebürstet
Surface polished

 Beispiel-Artikel-Nr.
Example Cat. No.
06-56-224
Black Line

 Oberfläche schwarz, titanbeschichtet
Surface black, titanium-coated

 Beispiel-Artikel-Nr.
Example Cat. No.
06-56-224B

TITAN

Artikel-Nr. Cat. No.	Artikel-Nr. Cat. No.	Gesamtlänge Total length
06-06-456	06-06-456T	200 mm / 8" 4 + 8 mm breit 4 + 8 mm wide
06-06-457	06-06-457T	200 mm / 8" 6 + 13 mm breit 6 + 13 mm wide
06-06-458	06-06-458T	200 mm / 8" 7 + 17 mm breit 7 + 17 mm wide
06-06-459	06-06-459T	200 mm / 8" 11 + 21 mm breit 11 + 21 mm wide biegsam malleable

1/2
06-06-457
200 mm
8"



Artikel-Nr. Cat. No.	Gesamtlänge Total length
06-06-201	200 mm / 8" 9 mm breit 9 mm wide
06-06-202	200 mm / 8" 12 mm breit 12 mm wide
06-06-222	250 mm / 10" 12 mm breit 12 mm wide gerieft, biegsam serrated, malleable

1/2
06-06-201
200 mm
8"



Standard Line	Black Line
Oberfläche matt gebürstet Surface polished	Oberfläche schwarz, titanbeschichtet Surface black, titanium-coated
Beispiel-Artikel-Nr. Example Cat. No. 06-06-201	Beispiel-Artikel-Nr. Example Cat. No. 06-06-201B



1/2
AACHEN
06-06-444
 200 mm
 8"

	Artikel-Nr. Cat. No.	Gesamtlänge Total length
AACHEN	06-06-441	200 mm / 8" 7 + 8 mm breit 7 + 8 mm wide
	06-06-442	200 mm / 8" 10 + 11 mm breit 10 + 11 mm wide
	06-06-443	200 mm / 8" 13 + 14 mm breit 13 + 14 mm wide
	06-06-444	200 mm / 8" 16 + 17 mm breit 16 + 17 mm wide
	06-06-445	200 mm / 8" 19 + 20 mm breit 19 + 20 mm wide
	06-06-446	200 mm / 8" 22 + 25 mm breit 22 + 25 mm wide

Standard Line

Oberfläche matt gebürstet
Surface polished

Beispiel-Artikel-Nr. **06-06-444**
 Example Cat. No.

Black Line

Oberfläche schwarz, titanbeschichtet
Surface black, titanium-coated

Beispiel-Artikel-Nr. **06-06-444B**
 Example Cat. No.

Artikel-Nr. Cat. No.	Gesamtlänge Total length		
02-20-751	200 mm / 8" 12 mm breit 12 mm wide		
02-20-752	200 mm / 8" 17 mm breit 17 mm wide		
02-20-755	250 mm / 10" 25 mm breit 25 mm wide biegsam malleable		

Artikel-Nr. Cat. No.	Gesamtlänge Total length	DAVIS	
06-56-200	180 mm / 7" 6 mm breit 6 mm wide		
06-56-201	180 mm / 7" 10 mm breit 10 mm wide		
06-56-202	180 mm / 7" 14 mm breit 14 mm wide		
06-56-203	180 mm / 7" 16 mm breit 16 mm wide		
06-56-204	180 mm / 7" 19 mm breit 19 mm wide		
06-56-205	180 mm / 7" 25 mm breit 25 mm wide		
06-56-206	180 mm / 7" 32 mm breit 32 mm wide		
06-56-207	180 mm / 7" 38 mm breit 38 mm wide biegsam malleable		



1/2
02-20-752
200 mm
8"



1/2
DAVIS
06-56-203
180 mm
7"

Standard Line	Black Line
Oberfläche matt gebürstet Surface polished	Oberfläche schwarz, titanbeschichtet Surface black, titanium-coated
Beispiel-Artikel-Nr. Example Cat. No. 06-56-203	Beispiel-Artikel-Nr. Example Cat. No. 06-56-203B



3

 1/2
CUSHING
06-06-212
 180 mm
 7"

		Artikel-Nr. Cat. No.	Gesamtlänge Total length
	CUSHING	06-06-211	180 mm / 7" 7 + 9 mm breit 7 + 9 mm wide
		06-06-212	180 mm / 7" 11 + 13 mm breit 11 + 13 mm wide
		06-06-213	180 mm / 7" 15 + 18 mm breit 15 + 18 mm wide
		06-06-214	180 mm / 7" 18 + 22 mm breit 18 + 22 mm wide
			biegsam malleable

 1/2
OLIVECRONA
06-06-217
 180 mm
 7"

		Artikel-Nr. Cat. No.	Gesamtlänge Total length
	OLIVECRONA	06-06-216	180 mm / 7" 7 + 9 mm breit 7 + 9 mm wide
		06-06-217	180 mm / 7" 11 + 13 mm breit 11 + 13 mm wide
		06-06-218	180 mm / 7" 15 + 18 mm breit 15 + 18 mm wide
		06-06-219	180 mm / 7" 18 + 22 mm breit 18 + 22 mm wide
			biegsam malleable

Standard Line

 Oberfläche matt gebürstet
 Surface polished

 Beispiel-Artikel-Nr.
 Example Cat. No.

06-06-212
Black Line

 Oberfläche schwarz, titanbeschichtet
 Surface black, titanium-coated

 Beispiel-Artikel-Nr.
 Example Cat. No.

06-06-212B

Artikel-Nr. Cat. No.	Gesamtlänge Total length		
06-06-231	200 mm / 8" 14 mm breit 14 mm wide		
06-06-232	200 mm / 8" 17 mm breit 17 mm wide		
06-06-233	200 mm / 8" 20 mm breit 20 mm wide biegsam malleable		



Artikel-Nr. Cat. No.	Gesamtlänge Total length	HEIFETZ	
06-56-254	155 mm / 6" 3 mm breit 3 mm wide		
06-56-255	155 mm / 6" 6 mm breit 6 mm wide		
06-06-256	155 mm / 6" 8 mm breit 8 mm wide		
06-06-257	155 mm / 6" 11 mm breit 11 mm wide		
06-06-258	155 mm / 6" 14 mm breit 14 mm wide		
06-06-259	155 mm / 6" 17 mm breit 17 mm wide biegsam malleable		

1/2
06-06-233
200 mm
8"



1/2
HEIFETZ
06-06-257
155 mm
6"

Standard Line	Black Line
Oberfläche matt gebürstet <i>Surface polished</i>	Oberfläche schwarz, titanbeschichtet <i>Surface black, titanium-coated</i>
Beispiel-Artikel-Nr. Example Cat. No. 06-06-233	Beispiel-Artikel-Nr. Example Cat. No. 06-06-233B

Modulares Haltesystem für die Neurochirurgie
Modular Retractor System for the Neurosurgery

Flexibel einsetzbar zur selbsthaltenden Fixierung von Spateln oder Instrumenten und als Handauflage für kontrolliertes und ermüdungsfreies Arbeiten. Zur Montage an allen gängigen Kopfhaltungen. Individueller Aufbau und Anpassung an die operativen Erfordernisse.

The retractor and handrest is a versatile system for the self-retaining fixation of instruments and spatulas that allows performance with more control and less fatigue. It attaches to all common skull clamps and can be individually assembled and adjusted to surgeons need.

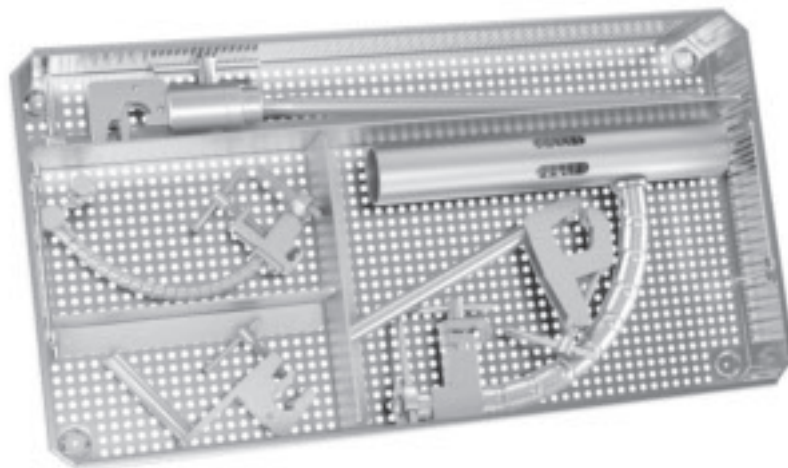
Artikel-Nr.
Cat. No.

06-45-000

Universal Haltesystem
universal retractor system

 bestehend aus:
 consisting of:

- 06-56-002** 2x Primärstange
primary bar
- 06-56-003** 4x Sekundärstange
secondary bar
- 06-56-006** 4x Haltearm lang, flexibel, 240 mm
long retractor arm, flexibel, 240 mm
- 06-56-001** 1x Handauflage mit flexiblem Arm, 245 mm
handrest with flexible arm, 245 mm
- 06-56-013** 1x Tupperablage
pattie tray
- 06-56-015** 1x Spatel, konisch 6 x 19 mm
spatula, conical 6 x 19 mm
- 06-56-016** 1x Spatel, konisch 4 x 16 mm
spatula, conical 4 x 16 mm
- 06-56-017** 1x Spatel, konisch 3,2 x 12,7 mm
spatula, conical 3.2 x 12.7 mm
- 06-56-018** 1x Spatel, konisch 2,4 x 9,5 mm
spatula, conical 2.4 x 9.5 mm
- 06-56-019** 1x Spatel, konisch 1,6 x 6 mm
spatula, conical 1.6 x 6 mm
- 06-56-014** 1x Siebkorb mit 4 Fächern und Deckel, 480 x 253 x 70 mm
tray with 4 compartments and lid, 480 x 253 x 70 mm

Artikel-Nr.
Cat. No.

06-56-002 Primärstange zur Aufnahme der Sekundärstange 06-56-003 und Anschlussstange 06-56-004. Montage an Kopfhalterung

primary bar for fixation of secondary bar 06-56-003 and floating secondary bar 06-56-004. For mounting to skull clamp



Artikel-Nr.
Cat. No.

06-56-003 Sekundärstange zur Montage an Primärstange 06-56-002 oder Anschlussstange 06-56-004

secondary bar for mounting to primary bar 06-56-002 and floating secondary bar 06-56-004



Artikel-Nr.
Cat. No.

06-56-004 Anschlussstange zur Montage an Primärstange 06-56-002 und Sekundärstange 06-56-003

floating secondary bar for mounting to primary bar 06-56-002 and secondary bar 06-56-003



Artikel-Nr.
Cat. No.

06-56-011 Kurzer Anschluss zur Aufnahme der Handauflage 06-56-001. Montage an Sekundärstange 06-56-003 oder Anschlussstange 06-56-004

short coupler to adapt handrest 06-56-001. Mounting to secondary bar 06-56-003 and floating secondary bar 06-56-004

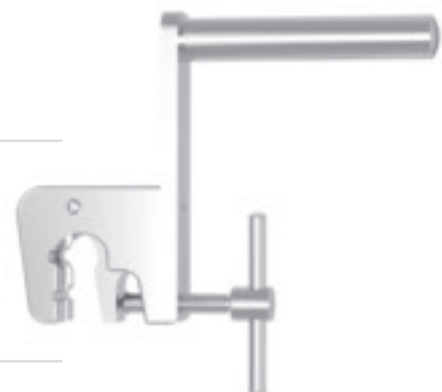

Artikel-Nr.
Cat. No.
Gesamtlänge
Total length

06-56-005

165 mm / 6½"

Haltearm kurz, flexibel, zur Aufnahme der Spatel. Montage an Sekundärstange 06-56-003 und Anschlussstange 06-56-004

flexible holding arm, short, to adapt the spatulas, for mounting to secondary bar 06-56-003 and floating secondary bar 06-56-004

06-56-006

240 mm / 9¾"

Haltearm lang, flexibel, zur Aufnahme der Spatel. Zur Montage an Sekundärstange 06-56-003 und Anschlussstange 06-56-004

flexible holding arm, long, to adapt the spatulas, for mounting to secondary bar 06-56-003 and floating secondary bar 06-56-004
Artikel-Nr.
Cat. No.
Haltearm flexibel, zur Aufnahme von:
Holding Arm, flexible, used to hold:

06-56-007

Mikro Instrumente bis
ø 3 mm / 1/8"
*micro instruments up to
ø 3 mm / 1/8"*

06-56-008

kleine Instrumente bis
ø 8 mm / 5/16"
*small instruments up to
ø 8 mm / 5/16"*

06-56-009

mittlere Instrumente bis
ø 25 mm / 1"
*medium instruments up to
ø 25 mm / 1"*

06-56-010

große Instrumente bis
ø 51 mm / 2"
*large instruments up to
ø 51 mm / 2"*

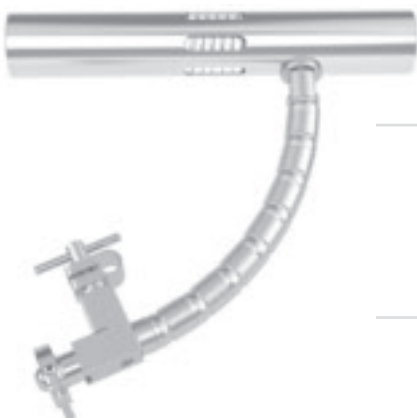
 Montage an Sekundärstange 06-56-003 und Anschlussstange 06-56-004
 for mounting to secondary bar 06-56-003 and floating secondary bar 06-56-004

Artikel-Nr.
Cat. No.
Gesamtlänge
Total length

06-56-001

245 mm / 9⅔"

Handauflage mit flexiblen Arm zur Montage an Anschluss 06-56-011

handrest with flexible arm for mounting to short coupler 06-56-011

Artikel-Nr.
Cat. No.

06-56-012	Maxi Vise Adapter zur Aufnahme von Instrumenten bis \varnothing 8 mm. Montage an die flexiblen Haltearme 06-56-005 und 06-56-006 <i>maxi vise adapter holds instruments up to \varnothing 8 mm, to be mounted to flexible holding arms 06-56-005 and 06-56-006</i>		
------------------	--	--	--

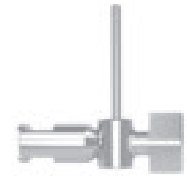

Artikel-Nr.
Cat. No.

Maße
Measurements

06-56-013	171 x 76 mm Tupferablage zur Montage an die flexiblen Haltearme 06-56-005 und 06-56-006 <i>pattie tray for mounting to fl xible holding arms 06-56-005 and 06-56-006</i>		
------------------	--	--	--



Artikel-Nr.
Cat. No.

Maße
Measurements

	230 mm / 9" Spatel konisch, schwarz, titanbeschichtet Montage an flexiblen Haltearmen 06-56-005 und 06-56-006 <i>spatula conical, black, titanium-coated, for mounting to flexible holding arms 06-56-005 and 06-56-006</i>		
06-56-015	6 x 19 mm		
06-56-016	4 x 16 mm		
06-56-017	3,2 x 12,7 mm		
06-56-018	2,4 x 9,5 mm		
06-56-019	1,6 x 6 mm		



Artikel-Nr.
Cat. No.



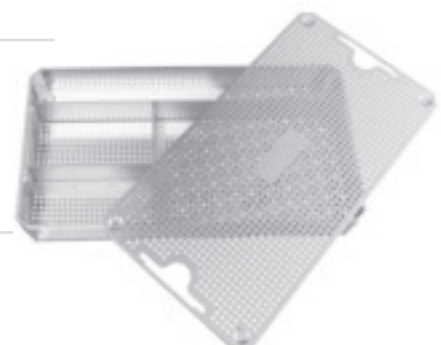

Maße
Measurements

06-56-014	480 x 253 x 70 mm Siebkorb mit 4 Fächern und Deckel zur Lagerung der Komponenten <i>tray with 4 compartments and lid for storage of the components</i>		
------------------	--	--	--



		Artikel-Nr. Cat. No.	
	1/3	HUDSON 06-06-058	Bogen allein <i>brace only</i>
		HUDSON 06-06-059	Verlängerungsstück allein <i>extension piece only</i>
		HUDSON 06-06-061	Bohrer <i>burr</i> ø 9 mm
		HUDSON 06-06-062	Bohrer <i>burr</i> ø 14 mm
		HUDSON 06-06-063	Bohrer <i>burr</i> ø 16 mm
		HUDSON 06-06-064	Bohrer <i>burr</i> ø 22 mm
		ADSON 06-06-065	Bohrer <i>burr</i> ø 15 mm
		MC KENZIE 06-06-066	Bohrer <i>burr</i> ø 13 mm

Artikel-Nr.
Cat. No.

06-56-064	Bohrer <i>burr</i>	ø 10 mm	CUSHING	
06-56-065	Bohrer <i>burr</i>	ø 15 mm	CUSHING	
06-56-066	Bohrer <i>burr</i>	ø 20 mm	CUSHING	
06-56-060	Flachbohrer <i>perforator drill</i>	ø 10 mm	CUSHING	
06-56-061	Flachbohrer <i>perforator drill</i>	ø 13 mm	CUSHING	
06-06-067	Flachbohrer <i>perforator drill</i>	ø 14 mm	CUSHING	
06-56-062	Flachbohrer <i>perforator drill</i>	ø 16 mm	CUSHING	
06-06-068	Spiralbohrer <i>twist drill</i>	ø 2 mm		
06-56-063	Bohrer <i>burr</i>	ø 16 mm	D'ERRICO	

Artikel-Nr.
 Cat. No.

	HUDSON DOWNS	06-06-052	Bogen allein <i>brace only</i>
	HUDSON DOWNS	06-06-053	Verlängerungsstück allein <i>extension piece only</i>
	HUDSON DOWNS	06-06-031	ø 10 mm Flachbohrer <i>perforator drill</i>
	HUDSON DOWNS	06-06-032	ø 12 mm Flachbohrer <i>perforator drill</i>
	HUDSON DOWNS	06-06-033	ø 15 mm Flachbohrer <i>perforator drill</i>
	HUDSON DOWNS (LEWIS)	06-06-034	ø 10 mm Flachbohrer <i>perforator drill</i>
	HUDSON DOWNS (LEWIS)	06-06-035	ø 12 mm Flachbohrer <i>perforator drill</i>
	HUDSON DOWNS (LEWIS)	06-06-036	ø 15 mm Flachbohrer <i>perforator drill</i>
	HUDSON DOWNS	06-06-037	ø 11 mm Bohrer <i>burr</i>

Artikel-Nr.
Cat. No.

06-06-038	Bohrer <i>burr</i>	ø 13 mm	HUDSON DOWNS	
06-06-039	Bohrer <i>burr</i>	ø 16 mm	HUDSON DOWNS	
06-06-040	Bohrer <i>burr</i>	ø 11 mm	HUDSON DOWNS	
06-06-041	Bohrer <i>burr</i>	ø 13 mm	HUDSON DOWNS	
06-06-042	Bohrer <i>burr</i>	ø 16 mm	HUDSON DOWNS	
06-06-043	Bohrer <i>burr</i>	ø 19 mm	HUDSON DOWNS	
06-06-044	Bohrer <i>burr</i>	ø 22 mm	HUDSON DOWNS	
06-06-048	Bohrer <i>burr</i>	ø 16 mm	MC KENZIE	
06-06-047	Bohrer <i>burr</i>		MC KENZIE	



1/2
DE VILBISS
06-56-112
 210 mm
 8¼"

Artikel-Nr.
Cat. No.

06-56-112

Gesamtlänge
Total length

210 mm / 8¼"

Schädelstanze mit je
 1 großen Blatt (06-56-110) und
 1 kleinen Blatt (06-56-111)

cranial rongeur with
1 large blade (06-56-110) and
1 small blade (06-56-111)



1/2
DAHLGREN
06-06-113
 210 mm
 8¼"

Artikel-Nr.
Cat. No.

06-06-113

Gesamtlänge
Total length

210 mm / 8¼"

Schädelstanze mit
 2 Reserveblättern (06-56-113)

cranial rongeur with
2 spare blades (06-56-113)

Artikel-Nr. Cat. No.	Gesamtlänge Total length		
06-06-050	205 mm / 8"		
	Bohrloch Schutzzange <i>burr hole protection forceps</i>		



1/2
06-06-050
205 mm
8"



1/2
06-08-403
 300 mm
 12"

	Artikel-Nr. Cat. No.	Gesamtlänge Total length
GIGLI	06-58-409	250 mm / 10"
	06-08-413	300 mm / 12"
	06-08-414	400 mm / 16"
	06-08-415	500 mm / 20"
	06-58-410	600 mm / 24"
	06-58-411	700 mm / 28"
		Dreifach gedreht Verkaufseinheit = 1 Stück 3 wires twisted sales unit = 1 pc.
OLIVE-CRONA	06-58-402	230 mm / 9"
	06-08-403	300 mm / 12"
	06-08-404	400 mm / 16"
	06-08-405	500 mm / 20"
	06-58-406	600 mm / 24"
	06-08-407	700 mm / 28"
	06-58-408	750 mm / 30"
		Zweifach gedreht Verkaufseinheit = 1 Stück 2 wires twisted sales unit = 1 pc.
OLIVE-CRONA-GIGLI	06-58-412	300 mm / 12"
	06-58-413	400 mm / 16"
	06-58-414	500 mm / 20"
	06-58-415	600 mm / 24"
	06-58-416	700 mm / 28"
		Vierfach gedreht Verkaufseinheit = 1 Stück 4 wires twisted sales unit = 1 pc.

Artikel-Nr. Cat. No.	Gesamtlänge Total length	GIGLI	1/2
06-08-480	Handgriffe für Drahtsägen, Packung á 2 Stück <i>handles for wire saws, package of 2 pieces</i>	GIGLI	1/2
06-58-480	Handgriffe für Drahtsägen, Packung á 2 Stück <i>handles for wire saws, package of 2 pieces</i>	GIGLI	
06-06-130	350 mm / 14" Umführungsinstrument für Drahtsägen, flexibel <i>conductor for wire saws, flexible</i>	DE MARTEL	
06-06-133	250 mm / 10" Umführungsinstrument für Drahtsägen <i>conductor for wire saws</i>	LEBSCHÉ	



1/3
DE MARTEL
06-06-130
 350 mm
 14"

1/2
LEBSCHÉ
06-06-133
 250 mm
 10"

3



1/1
FRAZIER
06-06-330
 100 mm
 4"

		Artikel-Nr. Cat. No.	Arbeitslänge Working length
	FRAZIER	06-06-330	100 mm / 4" ø 3 mm



1/1
FRAZIER
06-06-331
 70 mm
 2¾"

		Artikel-Nr. Cat. No.	Arbeitslänge Working length
	FRAZIER	06-06-331	70 mm / 2¾" ø 2 mm
		06-06-332	70 mm / 2¾" ø 2,5 mm

Artikel-Nr. Cat. No.	Gesamtlänge Total length		
06-56-330	0,7 x 80 mm / 3"	QUINKE	
06-56-331	0,7 x 90 mm / 3½"		
06-56-332	1,0 x 80 mm / 3"		
06-56-333	1,0 x 90 mm / 3½"		
06-56-334	1,2 x 90 mm / 3½"		
06-56-335	1,2 x 100 mm / 4"		
06-56-336	1,2 x 150 mm / 6"		



1/1
QUINKE
06-56-330
80 mm
3"

Artikel-Nr. Cat. No.	Gesamtlänge Total length		
06-56-337	1,3 x 80 mm / 3"	TUOHY	1/1
06-56-338	1,5 x 80 mm / 3"		
06-56-339	1,7 x 80 mm / 3"		



1/1
TUOHY
06-56-337
80 mm
3"

Artikel-Nr.
Cat. No.
CRUTCH-
FIELD
06-06-860

 Schädelhalter für Kinder
skull traction tongs for children

 1/3
CRUTCHFIELD
06-06-860

Artikel-Nr.
Cat. No.
CRUTCH-
FIELD
06-06-865

 Schädelhalter, mittlere Größe
skull traction tongs, medium size

 1/3
CRUTCHFIELD
06-06-865

Artikel-Nr.
Cat. No.
Größe
Size
06-06-861

ø 3,5 mm

 Vorbohrer für CRUTCHFIELD Schädelhalter
 06-06-860 und 06-06-865

drill for CRUTCHFIELD skull traction tongs
06-06-860 and 06-06-865
06-06-862

ø 5,0 mm

 Vorbohrer für CRUTCHFIELD Schädelhalter
 06-06-860 und 06-06-865

drill for CRUTCHFIELD skull traction tongs
06-06-860 and 06-06-865

Artikel-Nr.
Cat. No.

<p>06-06-870</p>	<p>Schädelhalter, großes Modell, mit verstellbaren Dornen <i>skull traction tongs, large type, with adjustable pins</i></p>		
<p>06-56-871</p>	<p>Ersatzdorn für Schädelhalter 06-06-870 <i>spare pin for skull traction tongs 06-06-870</i></p>		



1/3
06-06-870

Artikel-Nr.
Cat. No.

<p>06-56-030</p>	<p>Schädelhalter komplett, bestehend aus: Rahmen, 2 Muttern, Testrohr, S-Haken mit Schild, 2 Gewindebolzen <i>skull tongs complete, consisting of: frame, 2 lock nuts, test bar, s-hook, 2 fixation screws</i></p>	<p>GARNER- WELLS</p>	
-------------------------	---	---------------------------------	--





1/3
GARDNER-WELLS
06-56-030

		Artikel-Nr. Cat. No.	
	MC KENZIE	06-06-421	Klammerblock, allein <i>clip rack, empty</i>
	MC KENZIE	06-06-426	Silberklammern, Packung à 100 Stück <i>silver clips, package of 100 pieces</i>



1/2
 MC KENZIE
 06-56-424
 150 mm
 6"



		Artikel-Nr. Cat. No.		Gesamtlänge Total length
1/1	MC KENZIE	06-56-422		150 mm / 6"
		06-56-423		190 mm / 7½"
1/1	MC KENZIE	06-56-424		150 mm / 6"
		06-56-425		190 mm / 7½"



1/2
 OLIVECRONA-
 TOENNIS
 06-56-427
 140 mm
 5½"

		Artikel-Nr. Cat. No.		Schaftlänge Length of shaft
1/1	OLIVE- CRONA- TOENNIS	06-56-427		140 mm / 5½"
		06-56-428		200 mm / 8"

Artikel-Nr.
 Cat. No.

06-06-001	Kopfhautklammer, Packung à 12 Stück <i>scalp clips, package of 12 pieces</i>	RANEY	
06-06-005	Kopfhautklammer, Packung à 50 Stück <i>scalp clips, package of 50 pieces</i>	KÖLN	

Artikel-Nr.
 Cat. No.

Gesamtlänge
 Total length

06-06-003	160 mm / 6¼" Anlege- und Abnehmezange, für Kopfhautklammern 06-06-001 <i>applying and removing forceps for scalp clips 06-06-001</i>	RANEY	
-----------	---	-------	--



2/3
RANEY
06-06-003
 160 mm
 6¼"

3



		Artikel-Nr. Cat. No.	Gesamtlänge Total length
 	1/1	YASARGIL	
		06-06-020	310 mm / 12 $\frac{3}{4}$ "
		06-06-022	410 mm / 16"

1/2
YASARGIL
06-06-022
 410 mm
 16"

Area with horizontal lines for notes.



01

Mikro-Neurochirurgische Instrumente
Micro-Neurosurgical Instruments



02

HF-Instrumente und Zubehör
HF Instruments and Accessoires



03

Kopf-Schädelinstrumente und Haltesysteme
Head-Cranio Instruments and Holding Systems

Aneurysmen-Clip System
Aneurysm Clip System



05

Schädel-Verplattung
Cranial Plate System



06

Hypophysektomie-Instrumente
Pituitary Instruments



07

Instrumente für die Wirbelsäule, Wundspreizer
Spine Instruments, Self-retaining Retractors



08

Laminektomie-Stanzen, Rongeuere, Hohlmeißelzangen
Laminectomy Punches, Rongeurs



09

Gefäß- und Bulldogklemmen, Gefäß-Clips
Vessel- and Bulldog Clamps, Vessel Clips



10

Allgemeinchirurgische Instrumente
General Surgical Instruments



11

Alphabetischer Index, Numerischer Index
Alphabetical Index, Numerical Index

/// 04



SURGICAL
INSTRUMENTS
MICRO-NEURO-SPINE

REBSTOCK®
Precision made in Germany

/// Aneurysmen-Clip System
Aneurysm Clip System





VERPACKUNG – UNSTERIL
 Membrandose und Umkarton

PACKING – NON STERILE
 Membrane box and outer carton



VERPACKUNG – STERIL
 Blister und Umkarton

PACKING – STERILE
 Blister box and outer carton

Material / MR-Kompatibilität

Aneurysmen Clips werden aus TITAN gemäß ISO 5832-3 oder PHYNIX gemäß ISO 5832-7 hergestellt. Beide Implantat-Werkstoffe entsprechen höchsten Qualitätsansprüchen. Alle Aneurysmen Clips sind MRT-kompatibel bis zu einer Feldstärke von 3 Tesla.

Rückverfolgbarkeit

aufgrund individueller Seriennummer auf jedem Clip.

Garantierte Schließkraft

Computergesteuerte Druckmessung bei einem Drittel der Maullänge und 1,0 mm Öffnung.

Optimaler Verschluss

durch pyramidenförmiges atraumatisches Maulprofil.

Material / MRI-Compatibility

The aneurysm clips are made of TITANIUM according to ISO 5832-3 or PHYNIX according to ISO 5832-7. Both materials for implants meet high quality requirements. Every aneurysm clip is MRI-compatible up to a field strength of 3 Tesla.

Traceability

because of an individual serial number marked on each clip.

Guaranteed Closing Force

Computer controlled measuring of the closing force at one third of the jaw length and an opening of 1.0 mm.

Optimal Closure

because of atraumatic and pyramid formed profile of the jaw.

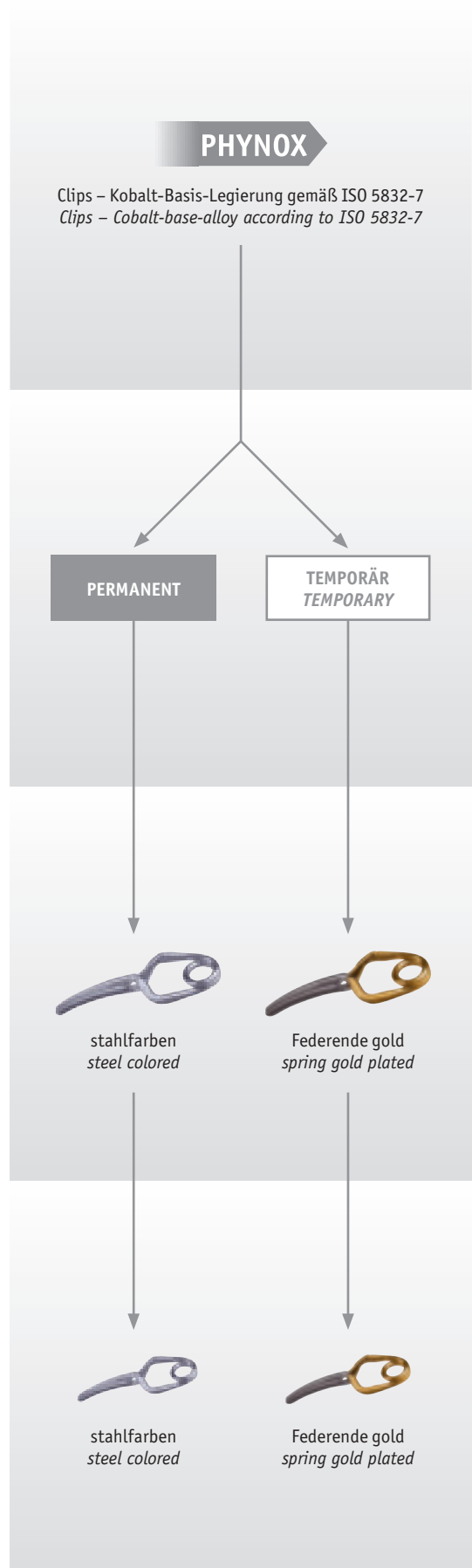
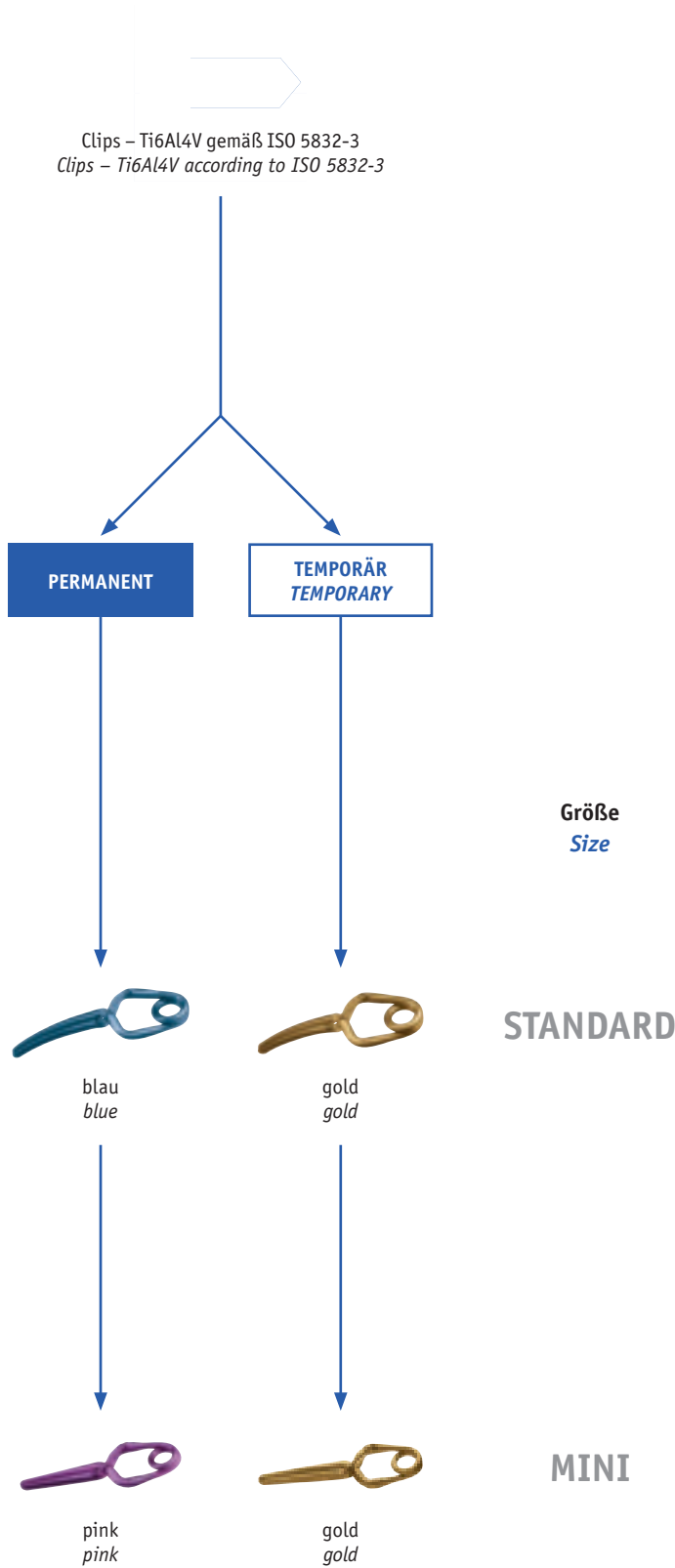

PERMANENT

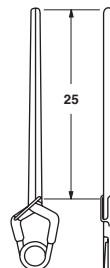
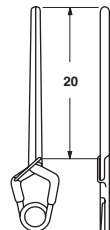
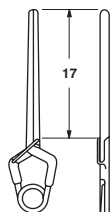
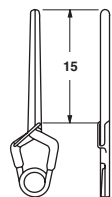
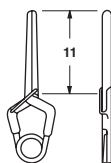
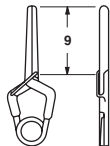
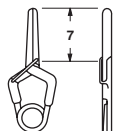

Öffnung Opening	6,2 mm	7,0 mm	7,8 mm	9,2 mm	10,6 mm	11,4 mm	13,3 mm
Druck Force	150 gms	180 gms	180 gms	200 gms	200 gms	200 gms	200 gms
	65 740T	65 750T	65 760T	65 780T	65 792T	65 790T	65 840T
STERILE	06-05-740T	06-05-750T	06-05-760T	06-05-780T	06-05-792T	06-05-790T	06-05-840T
	65 740	65 750	65 760	65 780	65 792	65 790	65 840
STERILE	06-05-740	06-05-750	06-05-760	06-05-780	06-05-792	06-05-790	06-05-840

TITAN

PHYNOX

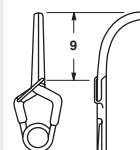
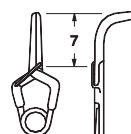
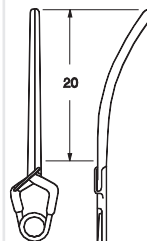
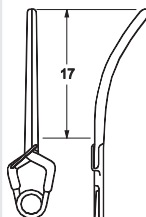
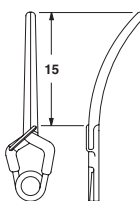
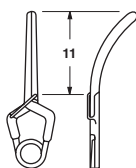
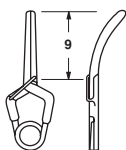
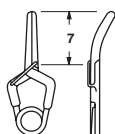

Öffnung Opening	6,0 mm	6,8 mm	7,5 mm	8,7 mm	10,0 mm	11,0 mm	5,5 mm	6,1 mm
Druck Force	150 gms	180 gms	180 gms	200 gms	180 gms	200 gms	150 gms	180 gms
	65 742T	65 752T	65 762T	65 782T	65 786T	65 895T	65 744T	65 754T
STERILE	06-05-742T	06-05-752T	06-05-762T	06-05-782T	06-05-786T	06-05-895T	06-05-744T	06-05-754T
	65 742	65 752	65 762	65 782	65 786	65 895	65 744	65 754
STERILE	06-05-742	06-05-752	06-05-762	06-05-782	06-05-786	06-05-895	06-05-744	06-05-754

TITAN

PHYNOX

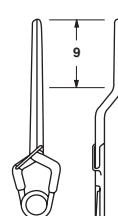
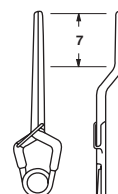
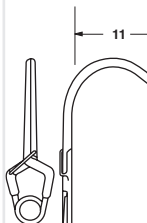
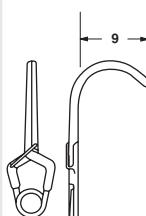
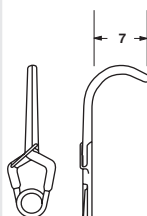
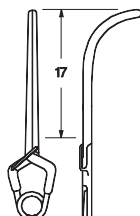
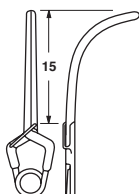
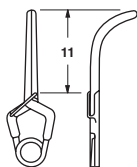

Öffnung Opening	6,5 mm	7,4 mm	9,9 mm	5,4 mm	5,8 mm	6,2 mm	7,9 mm	8,7 mm
Druck Force	180 gms	200 gms	200 gms	180 gms	180 gms	180 gms	200 gms	200 gms
	65 764T	65 784T	65 896T	65 823T	65 824T	65 825T	65 748T	65 758T
STERILE	06-05-764T	06-05-784T	06-05-896T	06-05-823T	06-05-824T	06-05-825T	06-05-748T	06-05-758T
	65 764	65 784	65 896	65 823	65 824	65 825	65 748	65 758
STERILE	06-05-764	06-05-784	06-05-896	06-05-823	06-05-824	06-05-825	06-05-748	06-05-758

TITAN

PHYNOX

TEMPORÄR
TEMPORARY

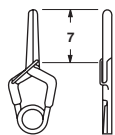

6,2 mm
110 gms

65 240T

06-05-240T

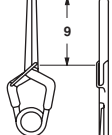

7,0 mm
90 gms

65 250T

06-05-250T

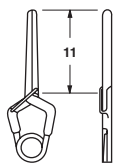

7,8 mm
90 gms

65 260T

06-05-260T

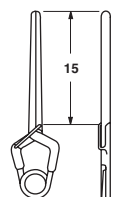

9,2 mm
90 gms

65 280T

06-05-280T

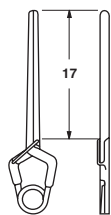

10,6 mm
90 gms

65 292T

06-05-292T

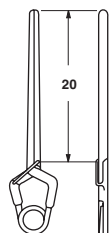

11,4 mm
110 gms

65 290T

06-05-290T

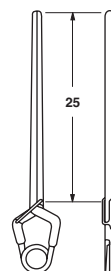

13,3 mm
110 gms

65 340 T

06-05-340T

Öffnung
Opening
Druck
Force

TITAN

STERILE

PHYNOX

65 240

65 250

65 260

65 280

65 292

65 290

65 340

06-05-240

06-05-250

06-05-260

06-05-280

06-05-292

06-05-290

06-05-340

STERILE

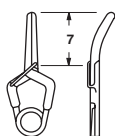

6,0 mm
110 gms

65 242T

06-05-242T

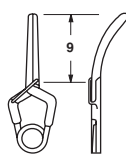

6,8 mm
90 gms

65 252T

06-05-252T

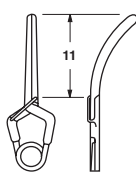

7,5 mm
90 gms

65 262T

06-05-262T

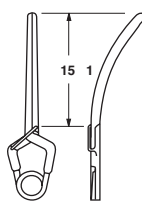

8,7 mm
110 gms

65 282T

06-05-282T

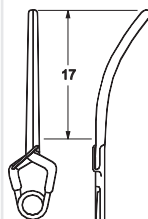

10,0 mm
110 gms

65 286T

06-05-286T

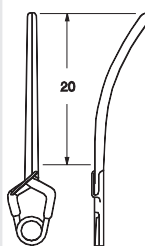

11,0 mm
90 gms

65 395T

06-05-395T

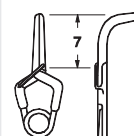

5,5 mm
110 gms

65 244T

06-05-244T

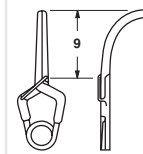

6,1 mm
110 gms

65 254T

06-05-254T

Öffnung
Opening
Druck
Force

TITAN

STERILE

PHYNOX

65 242

65 252

65 262

65 282

65 286

65 395

65 244

65 254

06-05-242

06-05-252

06-05-262

06-05-282

06-05-286

06-05-395

06-05-244

06-05-254

STERILE

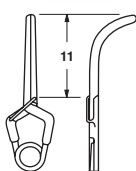

6,5 mm
110 gms

65 264T

06-05-264T

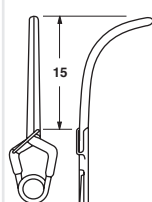

7,4 mm
110 gms

65 284T

06-05-284T

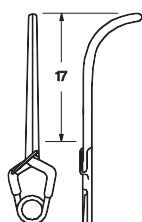

9,9 mm
90 gms

65 396T

06-05-396T

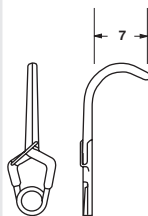

5,4 mm
110 gms

65 323T

06-05-323T

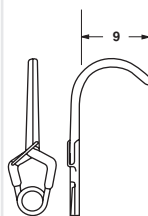

5,8 mm
110 gms

65 324T

06-05-324T

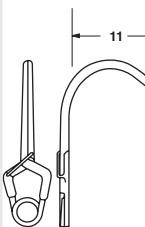

6,2 mm
110 gms

65 325T

06-05-325T

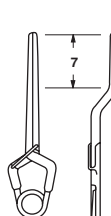

7,9 mm
90 gms

65 248T

06-05-248T

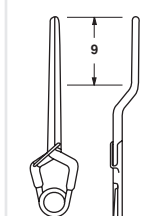

8,7 mm
90 gms

65 258T

06-05-258T

Öffnung
Opening
Druck
Force

TITAN

STERILE

PHYNOX

65 264

65 284

65 396

65 323

65 324

65 325

65 248

65 258

06-05-264

06-05-284

06-05-396

06-05-323

06-05-324

06-05-325

06-05-248

06-05-258

STERILE

PERMANENT

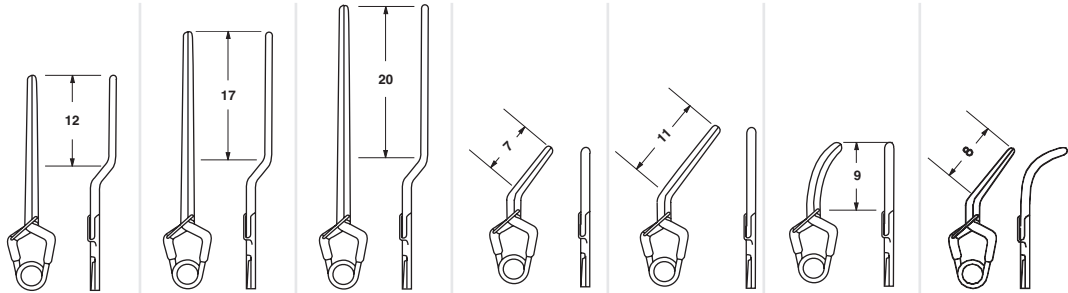

Öffnung Opening	10,2 mm	11,9 mm	13,0 mm	5,7 mm	8,0 mm	6,2 mm	6,5 mm
Druck Force	200 gms	180 gms	180 gms	200 gms	200 gms	200 gms	180 gms
	65 759T	65 797T	65 798T	65 746T	65 761T	65 747T	65 773T

STERILE	06-05-759T	06-05-797T	06-05-798T	06-05-746T	06-05-761T	06-05-747T	06-05-773T
----------------	-------------------	-------------------	-------------------	-------------------	-------------------	-------------------	-------------------

	65 759	65 797	65 798	65 746	65 761	65 747	65 773
STERILE	06-05-759	06-05-797	06-05-798	06-05-746	06-05-761	06-05-747	06-05-773

TITAN

PHYNOX

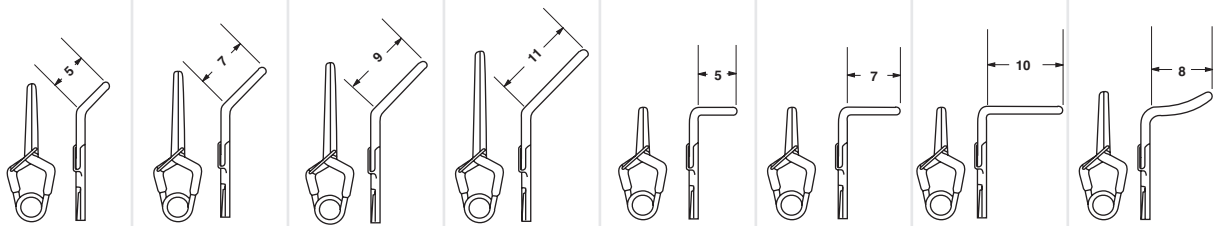

Öffnung Opening	6,2 mm	6,5 mm	7,8 mm	8,4 mm	5,6 mm	5,6 mm	5,6 mm	5,4 mm
Druck Force	200 gms	200 gms	200 gms	200 gms	200 gms	200 gms	200 gms	200 gms
	65 603T	65 613T	65 623T	65 763T	65 819T	65 820T	65 822T	65 850T

STERILE	06-05-603T	06-05-613T	06-05-623T	06-05-763T	06-05-819T	06-05-820T	06-05-822T	06-05-850T
----------------	-------------------	-------------------	-------------------	-------------------	-------------------	-------------------	-------------------	-------------------

	65 603	65 613	65 623	65 763	65 819	65 820	65 822	65 850
STERILE	06-05-603	06-05-613	06-05-623	06-05-763	06-05-819	06-05-820	06-05-822	06-05-850

TITAN

PHYNOX

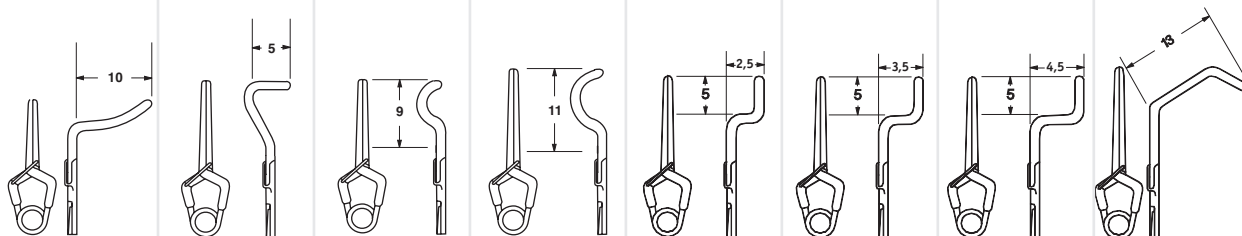

Öffnung Opening	5,6 mm	7,2 mm	7,2 mm	8,2 mm	8,0 mm	8,0 mm	8,0 mm	7,5 mm
Druck Force	200 gms	200 gms	200 gms	200 gms	200 gms	200 gms	200 gms	200 gms
	65 851T	65 830T	65 832T	65 833T	65 770T	65 771T	65 772T	65 897T

STERILE	06-05-851T	06-05-830T	06-05-832T	06-05-833T	06-05-770T	06-05-771	06-05-772T	06-05-897T
----------------	-------------------	-------------------	-------------------	-------------------	-------------------	------------------	-------------------	-------------------

	65 851	65 830	65 832	65 833	65 770	65 771	65 772	65 897
STERILE	06-05-851	06-05-830	06-05-832	06-05-833	06-05-770	06-05-771	06-05-772	06-05-897

TITAN

PHYNOX

TEMPORÄR
TEMPORARY

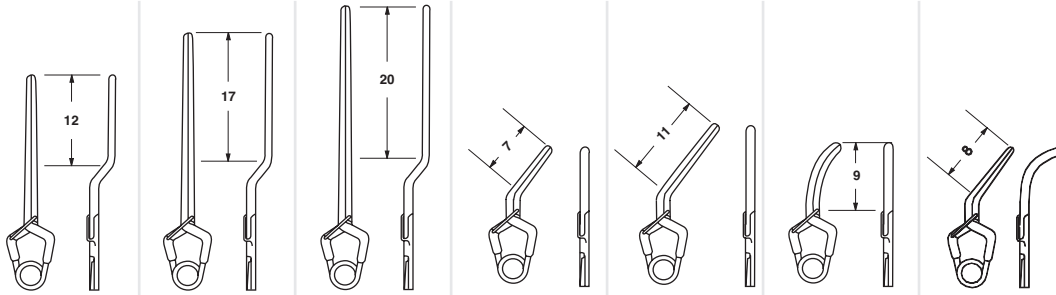

10,2 mm	11,9 mm	13,0 mm	5,7 mm	8,0 mm	6,2 mm	6,5 mm	Öffnung Opening
90 gms	90 gms	90 gms	90 gms	90 gms	90 gms	90 gms	Druck Force

TITAN

65 259T	65 297T	65 298T	65 246T	65 261T	65 247T	65 273 T	
06-05-259T	06-05-297T	06-05-298T	06-05-246T	06-05-261T	06-05-247T	06-05-273T	STERILE

PHYNOX

65 259	65 297	65 298	65 246	65 261	65 247	65 273	
06-05-259	06-05-297	06-05-298	06-05-246	06-05-261	06-05-247	06-05-273	STERILE

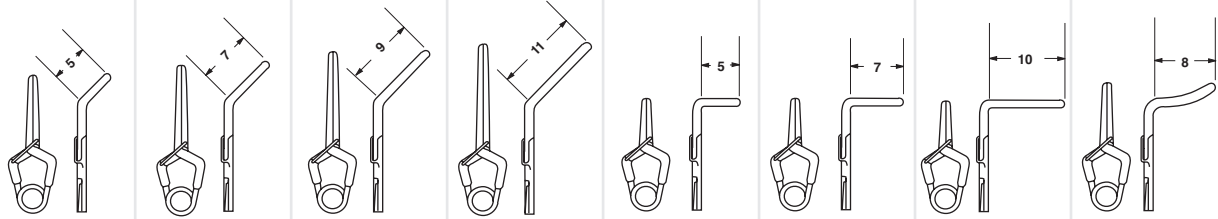

6,2 mm	6,5 mm	7,8 mm	8,4 mm	5,6 mm	5,6 mm	5,6 mm	5,4 mm	Öffnung Opening
110 gms	110 gms	110 gms	110 gms	130 gms	130 gms	110 gms	130 gms	Druck Force

TITAN

65 103T	65 113T	65 123T	65 263T	65 319T	65 320T	65 322T	65 350T	
06-05-103T	06-05-113T	06-05-123T	06-05-263T	06-05-319T	06-05-320T	06-05-322T	06-05-350T	STERILE

PHYNOX

65 103	65 113	65 123	65 263	65 319	65 320	65 322	65 350	
06-05-103	06-05-113	06-05-123	06-05-263	06-05-319	06-05-320	06-05-322	06-05-350	STERILE

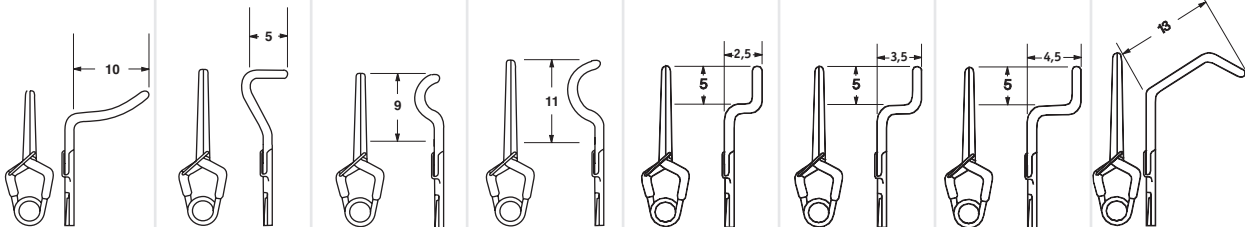

5,6 mm	7,2 mm	7,2 mm	8,2 mm	8,0 mm	8,0 mm	8,0 mm	7,5 mm	Öffnung Opening
130 gms	90 gms	90 gms	90 gms	90 gms	90 gms	90 gms	90 gms	Druck Force

TITAN

65 351T	65 330T	65 332T	65 333T	65 270T	65 271T	65 272T	65 397T	
06-05-351T	06-05-330T	06-05-332T	06-05-333T	06-05-270T	06-05-271T	06-05-272T	06-05-397T	STERILE

PHYNOX

65 351	65 330	65 332	65 333	65 270	65 271	65 272	65 397	
06-05-351	06-05-330	06-05-332	06-05-333	06-05-270	06-05-271	06-05-272	06-05-397	STERILE



PERMANENT

Öffnung Opening	7,4 mm	7,4 mm	7,4 mm	7,4 mm	8,4 mm	9,6 mm
Druck Force	150 gms	150 gms	150 gms	150 gms	150 gms	180 gms
	65 597T	65 598T	65 599T	65 600T	65 610T	65 620T
STERILE	06-05-597T	06-05-598T	06-05-599T	06-05-600T	06-05-610T	06-05-620T
	65 597	65 598	65 599	65 600	65 610	65 620
STERILE	06-05-597	06-05-598	06-05-599	06-05-600	06-05-610	06-05-620

TITAN

PHYNOX

Öffnung Opening	5,8 mm	6,5 mm	7,2 mm	4,9 mm	4,9 mm	4,9 mm
Druck Force	150 gms	150 gms	180 gms	150 gms	150 gms	180 gms
	65 602T	65 612T	65 622T	65 604T	65 614T	65 624T
STERILE	06-05-602T	06-05-612T	06-05-622T	06-05-604T	06-05-614T	06-05-624T
	65 602	65 612	65 622	65 604	65 614	65 624
STERILE	06-05-602	06-05-612	06-05-622	06-05-604	06-05-614	06-05-624

TITAN

PHYNOX

4

TEMPORÄR
 TEMPORARY

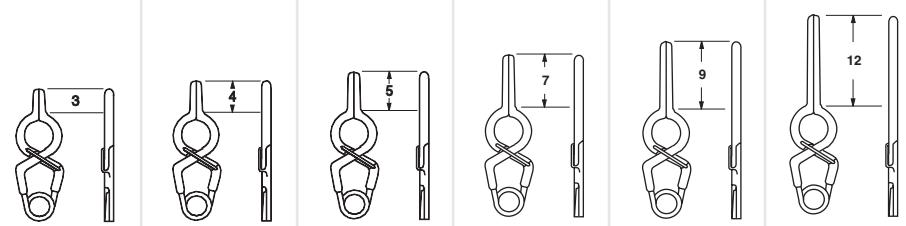

7,4 mm	7,4 mm	7,4 mm	7,4 mm	8,4 mm	9,0 mm	Öffnung Opening
110 gms	110 gms	110 gms	110 gms	110 gms	90 gms	Druck Force

TITAN	65 097T	65 098T	65 099T	65 100T	65 110T	65 120T	
	06-05-097T	06-05-098T	06-05-099T	06-05-100T	06-05-110T	06-05-120T	STERILE

PHYNOX	65 097	65 098	65 099	65 100	65 110	65 120	
	06-05-097	06-05-098	06-05-099	06-05-100	06-05-110	06-05-120	STERILE

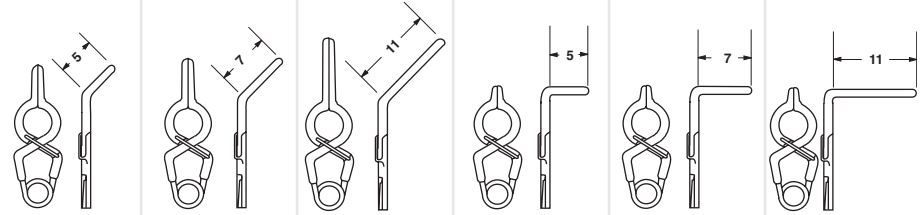

5,8 mm	6,5 mm	7,2 mm	4,9 mm	4,9 mm	4,9 mm	Öffnung Opening
110 gms	110 gms	110 gms	110 gms	110 gms	110 gms	Druck Force

TITAN	65 102T	65 112T	65 122T	65 104T	65 114T	65 124T	
	06-05-102T	06-05-112T	06-05-122T	06-05-104T	06-05-114T	06-05-124T	STERILE

PHYNOX	65 102	65 112	65 122	65 104	65 114	65 124	
	06-05-102	06-05-112	06-05-122	06-05-104	06-05-114	06-05-124	STERILE



PERMANENT

Öffnung Opening	7,4 mm	7,4 mm	7,4 mm	7,9 mm	9,1 mm	10,3 mm
Druck Force	150 gms	150 gms	150 gms	150 gms	150 gms	180 gms
	65 637T	65 638T	65 639T	65 640T	65 650T	65 660T
STERILE	06-05-637T	06-05-638T	06-05-639T	06-05-640T	06-05-650T	06-05-660T
	65 637	65 638	65 639	65 640	65 650	65 660
STERILE	06-05-637	06-05-638	06-05-639	06-05-640	06-05-650	06-05-660

TITAN

PHYNOX

Öffnung Opening	6,5 mm	7,2 mm	7,5 mm	7,8 mm	5,5 mm	5,5 mm
Druck Force	150 gms	150 gms	150 gms	180 gms	150 gms	150 gms
	65 642T	65 652T	65 853T	65 662T	65 644T	65 654T
STERILE	06-05-642T	06-05-652T	06-05-853T	06-05-662T	06-05-644T	06-05-654T
	65 642	65 652	65 853	65 662	65 644	65 654
STERILE	06-05-642	06-05-652	06-05-853	06-05-662	06-05-644	06-05-654

TITAN

PHYNOX

Öffnung Opening	5,5 mm	5,5 mm	5,5 mm	7,9 mm	8,8 mm	10,0 mm
Druck Force	150 gms	180 gms	150 gms	150 gms	150 gms	180 gms
	65 855T	65 664T	65 856T	65 648T	65 658T	65 668T
STERILE	06-05-855T	06-05-664T	06-05-856T	06-05-648T	06-05-658T	06-05-668T
	65 855	65 664	65 856	65 648	65 658	65 668
STERILE	06-05-855	06-05-664	06-05-856	06-05-648	06-05-658	06-05-668

TITAN

PHYNOX

TEMPORÄR
 TEMPORARY

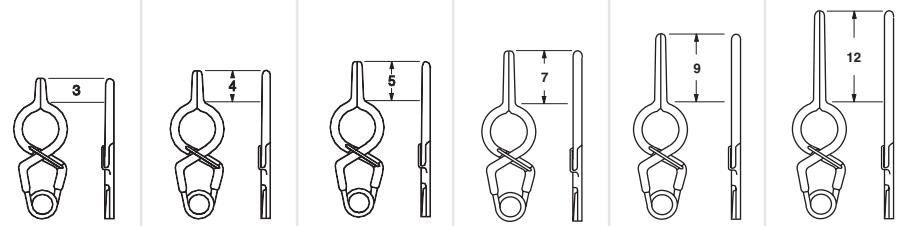

7,4 mm	7,4 mm	7,4 mm	7,9 mm	9,1 mm	10,3 mm	Öffnung Opening Druck Force
110 gms	110 gms	110 gms	110 gms	100 gms	90 gms	

TITAN	65 137T	65 138T	65 139T	65 140T	65 150T	65 160T	STERILE
	06-05-137T	06-05-138T	06-05-139T	06-05-140T	06-05-150T	06-05-160T	
PHYNOX	65 137	65 138	65 139	65 140	65 150	65 160	STERILE
	06-05-137	06-05-138	06-05-139	06-05-140	06-05-150	06-05-160	

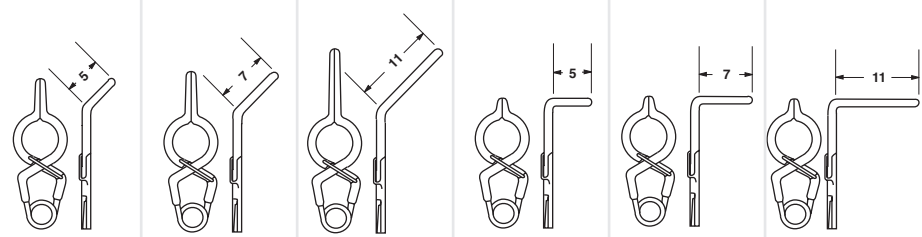

6,5 mm	7,2 mm	7,8 mm	5,5 mm	5,5 mm	5,5 mm	Öffnung Opening Druck Force
110 gms	110 gms	110 gms	110 gms	110 gms	90 gms	

TITAN	65 142T	65 152T	65 162T	65 144T	65 154T	65 164T	STERILE
	06-05-142T	06-05-152T	06-05-162T	06-05-144T	06-05-154T	06-05-164T	
PHYNOX	65 142	65 152	65 162	65 144	65 154	65 164	STERILE
	06-05-142	06-05-152	06-05-162	06-05-144	06-05-154	06-05-164	

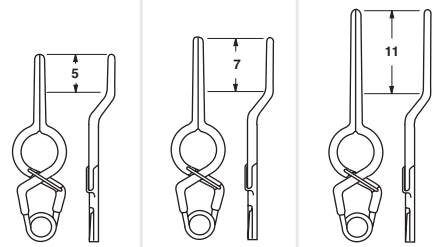

7,9 mm	8,8 mm	10,0 mm	Öffnung Opening Druck Force
90 gms	90 gms	90 gms	

TITAN	65 148T	65 158T	65 168T	STERILE
	06-05-148T	06-05-158T	06-05-168T	
PHYNOX	65 148	65 158	65 168	STERILE
	06-05-148	06-05-158	06-05-168	



PERMANENT

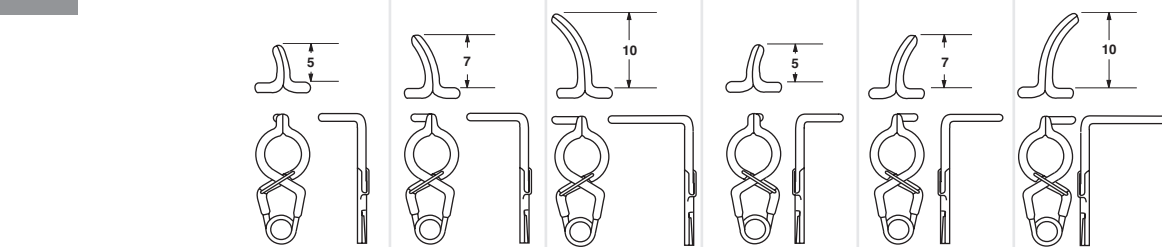

Öffnung Opening	5,8 mm	5,8 mm	5,8 mm	5,8 mm	5,8 mm	5,8 mm
Druck Force	150 gms	150 gms	150 gms	150 gms	150 gms	150 gms

	65 774T	65 775T	65 776T	65 777T	65 778T	65 779T
STERILE	06-05-774T	06-05-775T	06-05-776T	06-05-777T	06-05-778T	06-05-779T
	65 774	65 775	65 776	65 777	65 778	65 779
STERILE	06-05-774	06-05-775	06-05-776	06-05-777	06-05-778	06-05-779

TITAN

PHYNOX

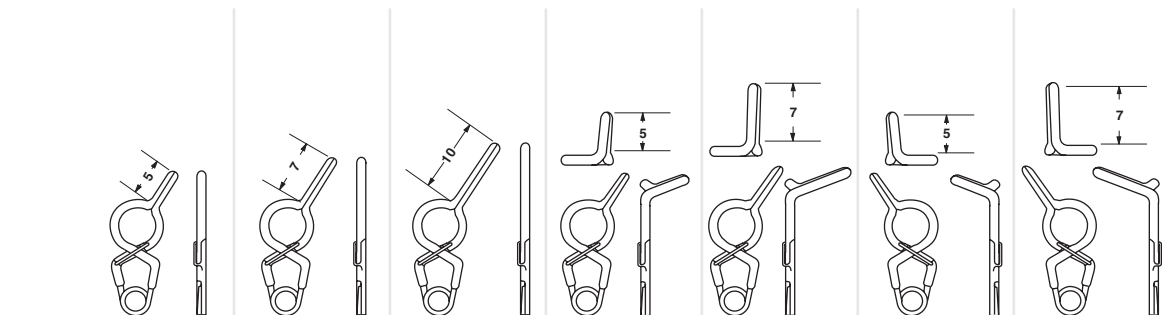

Öffnung Opening	7,0 mm	7,8 mm	8,8 mm	5,8 mm	6,2 mm	5,8 mm	6,2 mm
Druck Force	150 gms	150 gms	150 gms	150 gms	150 gms	150 gms	150 gms

	65 881T	65 882T	65 883T	65 886T	65 887T	65 888T	65 889T
STERILE	06-05-881T	06-05-882T	06-05-883T	06-05-886T	06-05-887T	06-05-888T	06-05-889T
	65 881	65 882	65 883	65 886	65 887	65 888	65 889
STERILE	06-05-881	06-05-882	06-05-883	06-05-886	06-05-887	06-05-888	06-05-889

TITAN

PHYNOX

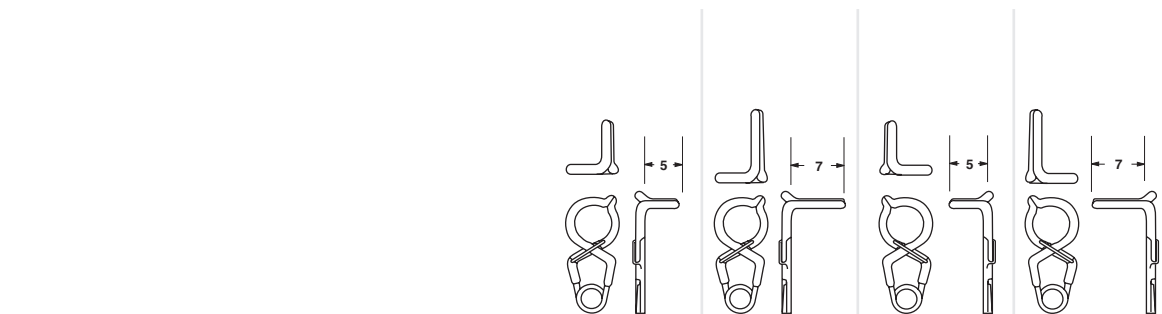

Öffnung Opening	5,6 mm	5,6 mm	5,6 mm	5,6 mm
Druck Force	150 gms	150 gms	150 gms	150 gms

	65 891T	65 892T	65 893T	65 894T
STERILE	06-05-891T	06-05-892T	06-05-893T	06-05-894T
	65 891	65 892	65 893	65 894
STERILE	06-05-891	06-05-892	06-05-893	06-05-894

TITAN

PHYNOX

TEMPORÄR
 TEMPORARY

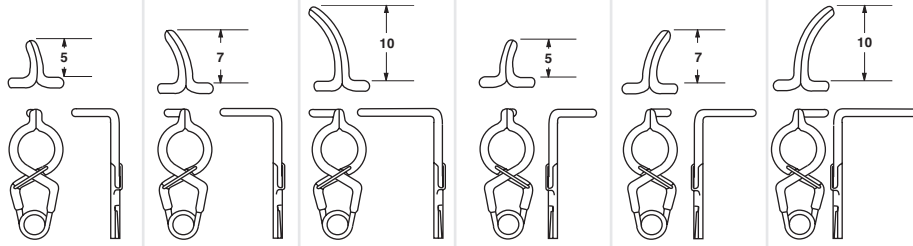

5,8 mm 5,8 mm 5,8 mm 5,8 mm 5,8 mm 5,8 mm
 110 gms 110 gms 110 gms 110 gms 110 gms 110 gms

Öffnung
 Opening
 Druck
 Force

TITAN

65 274T 65 275T 65 276T 65 277T 65 278T 65 279T

06-05-274T 06-05-275T 06-05-276T 06-05-277T 06-05-278T 06-05-279T

STERILE

PHYNOX

65 274 65 275 65 276 65 277 65 278 65 279

06-05-274 06-05-275 06-05-276 06-05-277 06-05-278 06-05-279

STERILE

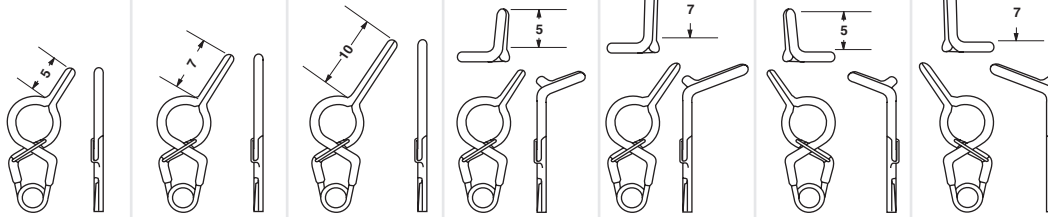

7,0 mm 7,8 mm 8,8 mm 5,8 mm 6,2 mm 5,8 mm 6,2 mm
 110 gms 110 gms 110 gms 110 gms 110 gms 110 gms 110 gms

Öffnung
 Opening
 Druck
 Force

TITAN

65 381T 65 382T 65 383T 65 386T 65 387T 65 388T 65 389T

06-05-381T 06-05-382T 06-05-383T 06-05-386T 06-05-387T 06-05-388T 06-05-389T

STERILE

PHYNOX

65 381 65 382 65 383 65 386 65 387 65 388 65 389

06-05-381 06-05-382 06-05-383 06-05-386 06-05-387 06-05-388 06-05-389

STERILE

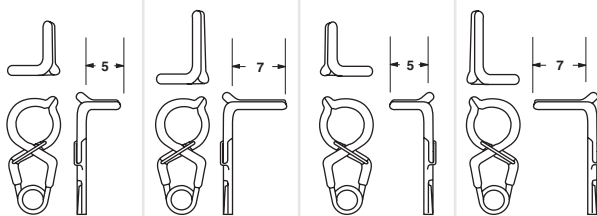

5,6 mm 5,6 mm 5,6 mm 5,6 mm
 110 gms 110 gms 110 gms 110 gms

Öffnung
 Opening
 Druck
 Force

TITAN

65 391T 65 392T 65 393T 65 394T

06-05-391T 06-05-392T 06-05-393T 06-05-394T

STERILE

PHYNOX

65 391 65 392 65 393 65 394

06-05-391 06-05-392 06-05-393 06-05-394

STERILE



PERMANENT

Öffnung Opening	3,3 mm	4,0 mm	3,3 mm	4,0 mm	4,6 mm	3,2 mm	3,8 mm
Druck Force	110 gms	110 gms	110 gms	110 gms	110 gms	110 gms	110 gms
	65 680T	65 690T	65 700T	65 710T	65 720T	65 682T	65 692T
STERILE	06-05-680T	06-05-690T	06-05-700T	06-05-710T	06-05-720T	06-05-682T	06-05-692T
	65 680	65 690	65 700	65 710	65 720	65 682	65 692
STERILE	06-05-680	06-05-690	06-05-700	06-05-710	06-05-720	06-05-682	06-05-692

TITAN

PHYNOX

Öffnung Opening	3,6 mm	3,8 mm	3,6 mm	4,0 mm	4,4 mm	3,6 mm	3,5 mm
Druck Force	110 gms	110 gms	110 gms	110 gms	110 gms	110 gms	110 gms
	65 711T	65 712T	65 713T	65 726T	65 722T	65 694T	65 714T
STERILE	06-05-711T	06-05-712T	06-05-713T	06-05-726T	06-05-722T	06-05-694T	06-05-714T
	65 711	65 712	65 713	65 726	65 722	65 694	65 714
STERILE	06-05-711	06-05-712	06-05-713	06-05-726	06-05-722	06-05-694	06-05-714

TITAN

PHYNOX

Öffnung Opening	4,0 mm	3,5 mm	6,0 mm	7,0 mm	5,7 mm	4,5 mm	4,0 mm
Druck Force	110 gms	130 gms	130 gms	130 gms	130 gms	130 gms	130 gms
	65 724T	65 716T	65 717T	65 727T	65 728T	65 806T	65 807T
STERILE	06-05-724T	06-05-716T	06-05-717T	06-05-727T	06-05-728T	06-05-806T	06-05-807T
	65 724	65 716	65 717	65 727	65 728	65 806	65 807
STERILE	06-06-724	06-05-716	06-05-717	06-05-727	06-05-728	06-05-806	06-05-807

TITAN

PHYNOX

TEMPORÄR
TEMPORARY

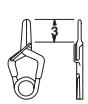

3,3 mm
90 gms

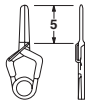

4,0 mm
70 gms

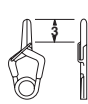

3,3 mm
90 gms

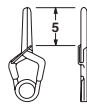

4,0 mm
70 gms

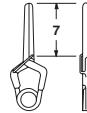

4,6 mm
70 gms

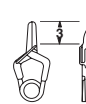

3,2 mm
90 gms

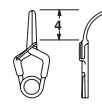

3,8 mm
70 gms

Öffnung
Opening
Druck
Force

TITAN

65 180T

65 190T

65 200T

65 210T

65 220T

65 182T

65 192T

06-05-180T

06-05-190T

06-05-200T

06-05-210T

06-05-220T

06-05-182T

06-05-192T

STERILE

PHYNOX

65 180

65 190

65 200

65 210

65 220

65 182

65 192

06-05-180

06-05-190

06-05-200

06-05-210

06-05-220

06-05-182

06-05-192

STERILE

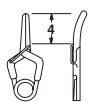

3,6 mm
80 gms

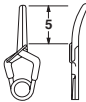

3,8 mm
70 gms

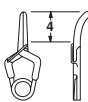

3,6 mm
80 gms

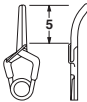

4,0 mm
70 gms

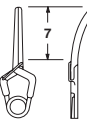

4,4 mm
70 gms

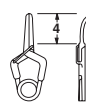

3,6 mm
80 gms

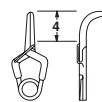

3,5 mm
80 gms

Öffnung
Opening
Druck
Force

TITAN

65 211T

65 212T

65 213T

65 226T

65 222T

65 194T

65 214T

06-05-211T

06-05-212T

06-05-213T

06-05-226T

06-05-222T

06-05-194T

06-05-214T

STERILE

PHYNOX

65 211

65 212

65 213

65 226

65 222

65 194

65 214

06-05-211

06-05-212

06-05-213

06-05-226

06-05-222

06-05-194

06-05-214

STERILE

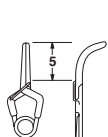

4,0 mm
70 gms

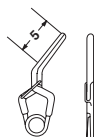

3,5 mm
70 gms

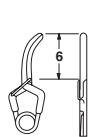

6,0 mm
70 gms

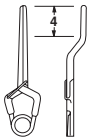

7,0 mm
70 gms

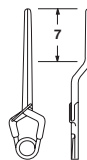

5,7 mm
70 gms

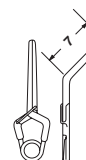

4,5 mm
70 gms

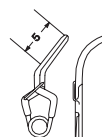

4,0 mm
70 gms

Öffnung
Opening
Druck
Force

TITAN

65 224T

65 216T

65 217T

65 227T

65 228T

65 306T

65 307T

06-05-224T

06-05-216T

06-05-217T

06-05-227T

06-05-228T

06-05-306T

06-05-307T

STERILE

PHYNOX

65 224

65 216

65 217

65 227

65 228

65 306

65 307

06-05-224

06-05-216

06-05-217

06-05-227

06-05-228

06-05-306

06-05-307

STERILE



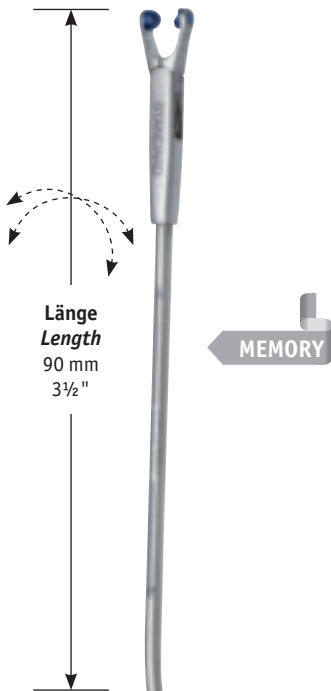

Memory Anlegezangen für STANDARD Clips

Der Memory Schaft kann flexibel gebogen werden.

Bei der Sterilisation nimmt er seine ursprüngliche Form ein.

Memory Applying Forceps for STANDARD Clips

The memory shaft is flexible and can be bent.

The memory shaft turns back to its initial shape during sterilisation.

4

Länge
Length
90 mm
3 1/2"

MEMORY

	für/for PHYNOX-Clips	für/for TITAN-Clips	
	Artikel-Nr. Cat. No.	Artikel-Nr. Cat. No.	Arbeitslänge Working length
<p>MEMORY STANDARD</p>	06-55-552	06-55-555T	70 mm / 2 3/4"
	06-55-553	06-55-556T	90 mm / 3 1/2"
	06-55-554	06-55-557T	110 mm / 4 1/3"
			Maul drehbar, MEMORY Schaft flexibel biegsam, mit Spülanschluss
			<i>jaw rotatable, MEMORY shaft flexible, with irrigation adapter</i>

	für/for PHYNOX-Clips	für/for TITAN-Clips	
	Artikel-Nr. Cat. No.	Artikel-Nr. Cat. No.	Arbeitslänge Working length
<p>Anwendungsbeispiel example for use</p>	06-20-402	06-20-402T	Einstellschlüssel zum Positionieren der drehbaren Maulbacken
			<i>adjusting key for positioning of the rotatable jaws</i>
	06-20-900	06-20-900T	Clip zur Verstärkung des Schließdrucks bei STANDARD Aneurysmen Clips
			<i>The booster clip increases the closing force of STANDARD aneurysm clips</i>

1/1
06-55-556T
90 mm
3 1/2"

Memory Anlegezangen für MINI Clips

Der Memory Schaft kann flexibel gebogen werden.
 Bei der Sterilisation nimmt er seine ursprüngliche Form ein.

Memory Applying Forceps for MINI Clips

The memory shaft is flexible and can be bent.
The memory shaft turns back to it's initial shape during sterilisation.

für/for
PHYNOX-Clips

für/for
TITAN-Clips

Artikel-Nr. Cat. No.	Artikel-Nr. Cat. No.	Arbeitslänge Working length
06-55-558	06-55-561T	70 mm / 2¾"
06-55-559	06-55-562T	90 mm / 3½"
06-55-560	06-55-563T	110 mm / 4⅓"

Maul drehbar,
 MEMORY Schaft
 flexibel biegsam,
 mit Spülanschluss

*jaw rotatable,
 MEMORY shaft flexible,
 with irrigation adapter*

MEMORY
 MINI



1/1
06-55-562T
 90 mm
 3½"

Anlegezangen für STANDARD Clips
 Applying Forceps for STANDARD Clips

 für/for
 TITAN-Clips

 Artikel-Nr.
 Cat. No.

 Gesamtlänge
 Total length

	STANDARD	Artikel-Nr. Cat. No.	Gesamtlänge Total length
		06-05-412T	210 mm / 8¼"
		06-55-514T	230 mm / 9"
			Maul drehbar und abwinkelbar <i>jaw rotatable and adjustable</i>

 1/1
 06-05-412T
 210 mm
 8¼"

Anlegezangen für MINI Clips
Applying Forceps for MINI Clips

für/for
TITAN-Clips



Artikel-Nr.
 Cat. No.

Gesamtlänge
 Total length

MINI

06-05-402T

210 mm / 8¼"

06-55-504T

230 mm / 9"

Maul drehbar
 und abwinkelbar

*jaw rotatable
 and adjustable*



4

1/1
06-05-402T
 210 mm
 8¼"

Anlegezangen für STANDARD Clips
 Applying Forceps for STANDARD Clips

 für/for
 TITAN-Clips

		Artikel-Nr. Cat. No.	Gesamtlänge Total length
	STANDARD	06-20-480T	190 mm / 7½"
		06-20-482T	210 mm / 8¼"
		06-20-484T	230 mm / 9"
Maul starr, gerade <i>jaw fixed, straight</i>			
	STANDARD	06-20-485T	210 mm / 8¼"
		06-20-487T	230 mm / 9"
Maul starr, 15° aufwärts gewinkelt <i>jaw fixed, 15° upward angled</i>			
	STANDARD	06-55-528T	210 mm / 8¼"
		06-55-529T	230 mm / 9"
Maul drehbar <i>jaw rotatable</i>			

 1/1
06-55-528T
 210 mm
 8¼"

Anlegezangen für MINI Clips
Applying Forceps for MINI Clips

für/for
TITAN-Clips



Artikel-Nr. Cat. No.	Gesamtlänge Total length		
06-20-470T	190 mm / 7½"	MINI	
06-20-472T	210 mm / 8¼"		
06-20-474T	230 mm / 9"		
	Maul starr, gerade <i>jaw fixed, straight</i>		
06-20-475T	210 mm / 8¼"	MINI	
06-20-477T	230 mm / 9"		
	Maul starr, 15° aufwärts gewinkelt <i>jaw fixed, 15° upward angled</i>		
06-55-522T	210 mm / 8¼"	MINI	
06-55-524T	230 mm / 9"		
	Maul drehbar <i>jaw rotatable</i>		



4

1/1
06-55-522T
 210 mm
 8¼"

Anlegezangen für STANDARD Clips
 Applying Forceps for STANDARD Clips

 für/for
 PHYNOX-Clips

		Artikel-Nr. Cat. No.	Gesamtlänge Total length
	STANDARD	06-05-580	170 mm / 6¾"
		06-05-582	210 mm / 8¼"
		06-05-584	230 mm / 9"
Maul starr, gerade <i>jaw fixed, straight</i>			
	STANDARD	06-05-585	210 mm / 8¼"
		06-05-587	230 mm / 9"
Maul starr, 15° aufwärts gewinkelt <i>jaw fixed, 15° upward angled</i>			
	STANDARD	06-05-512	210 mm / 8¼"
		06-55-513	230 mm / 9"
Maul drehbar und abwinkelbar <i>jaw rotatable and adjustable</i>			

 1/1
 06-05-582
 210 mm
 8¼"

Anlegezangen für MINI Clips
 Applying Forceps for MINI Clips

für/for
 PHYNOX-Clips



Artikel-Nr. Cat. No.	Gesamtlänge Total length		
06-05-570	170 mm / 6¾"	MINI	
06-05-572	210 mm / 8¼"		
06-05-574	230 mm / 9"		
	Maul starr, gerade jaw fixed, straight		
06-05-575	210 mm / 8¼"	MINI	
06-05-577	230 mm / 9"		
	Maul starr, 15° aufwärts gewinkelt jaw fixed, 15° upward angled		
06-05-502	210 mm / 8¼"	MINI	
06-55-503	230 mm / 9"		
	Maul drehbar und abwinkelbar jaw rotatable and adjustable		



4

1/1
 06-05-572
 210 mm
 8¼"

Ringgriff Anlegezangen für STANDARD Clips
 Ring Handle Applying Forceps for STANDARD Clips
für/for
PHYNOX-Clipsfür/for
TITAN-ClipsArtikel-Nr.
Cat. No.Artikel-Nr.
Cat. No.Schaftlänge
Length of shaft

	STANDARD	06-55-590	06-55-590T	160 mm / 6 1/4"
		06-05-530	06-05-530T	180 mm / 7"
Maul starr, Schaft 360° drehbar, mit Spülanschluss <i>jaw fixed, shaft 360° rotatable with irrigation adapter</i>				
	STANDARD	06-55-591	06-55-591T	160 mm / 6 1/4"
		06-55-592	06-55-592T	180 mm / 7"
Maul drehbar, Schaft 360° drehbar, mit Spülanschluss <i>jaw rotatable, shaft 360° rotatable with irrigation adapter</i>				

Ringgriff Anlegezangen für MINI Clips
 Ring Handle Applying Forceps for MINI Clips

für/for
 PHYNOX-Clips

für/for
 TITAN-Clips

Artikel-Nr. Cat. No.	Artikel-Nr. Cat. No.	Schaftlänge Length of shaft		
06-55-594	06-55-594T	160 mm / 6¼"	MINI	
06-05-520	06-05-520T	180 mm / 7"		
		Maul starr, Schaft 360° drehbar, mit Spülanschluss <i>jaw fixed, shaft 360° rotatable with irrigation adapter</i>		
06-55-595	06-55-595T	160 mm / 6¼"	MINI	
06-55-596	06-55-596T	180 mm / 7"		
		Maul drehbar, Schaft 360° drehbar, mit Spülanschluss <i>jaw rotatable, shaft 360° rotatable with irrigation adapter</i>		



Anlegezange für STANDARD Clips, gerade
Applying Forceps for STANDARD Clips, straight

 für/for
 PHYNOX-Clips

Artikel-Nr.
Cat. No.
Gesamtlänge
Total length

	STANDARD	06-05-558	180 mm / 7"
			Maul starr jaw fixed

 1/1
06-05-558
 180 mm
 7"

Anlegezange für MINI Clips, gerade
Applying Forceps for MINI Clips, straight

für/for
PHYNOX-Clips



Artikel-Nr. Cat. No.	Gesamtlänge Total length		
06-05-548	180 mm / 7" Maul starr jaw fixed	MINI	





4

1/1
06-05-548
180 mm
7"

Entnahmezangen für STANDARD Clips
 Removers for STANDARD Clips

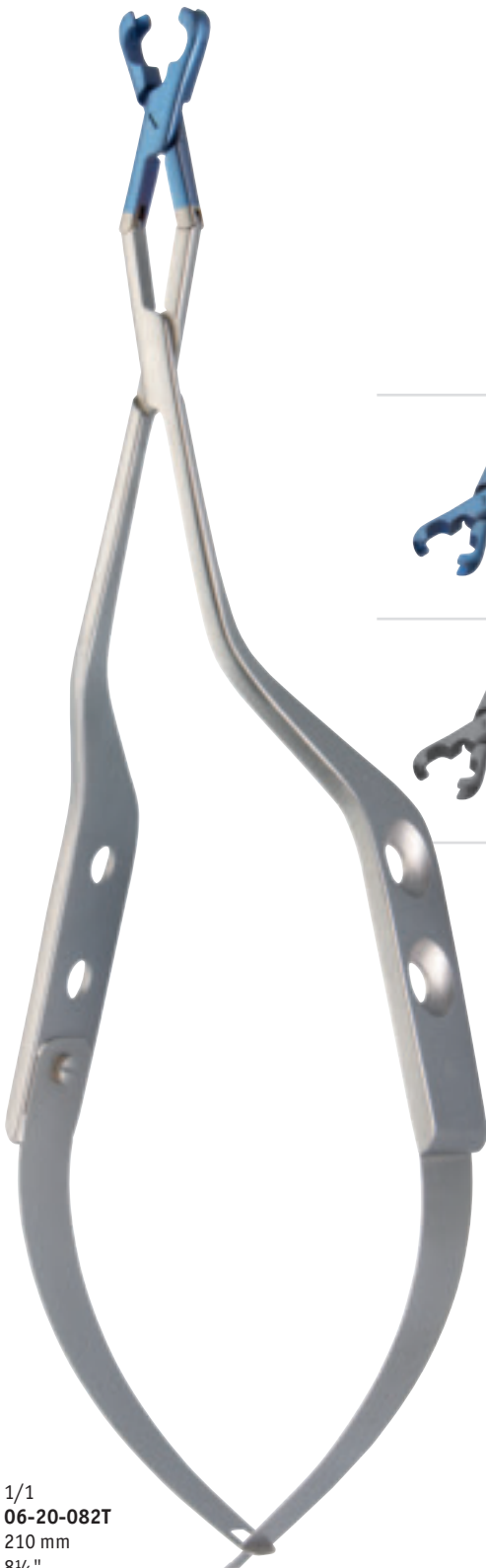
4

für/for
PHYNOX-Clipsfür/for
TITAN-ClipsArtikel-Nr.
Cat. No.Artikel-Nr.
Cat. No.Gesamtlänge
Total length

	STANDARD		06-20-082T	210 mm / 8¼"
				Maul starr, gerade jaw fixed, straight
	STANDARD	06-20-082		210 mm / 8¼"
				Maul starr, gerade jaw fixed, straight

 1/1
 06-20-082T
 210 mm
 8¼"



Entnahmezangen für MINI Clips
 Removers for MINI Clips

für/for
 PHYNOX-Clips



für/for
 TITAN-Clips



Artikel-Nr. Cat. No.	Artikel-Nr. Cat. No.	Gesamtlänge Total length		
	06-20-072T	210 mm / 8¼"	MINI	
06-20-072		210 mm / 8¼"	MINI	



4

1/1
06-20-072T
 210 mm
 8¼"



Artikel-Nr.
Cat. No.

06-20-002

Maße
Measurements

528 x 254 x 40 mm

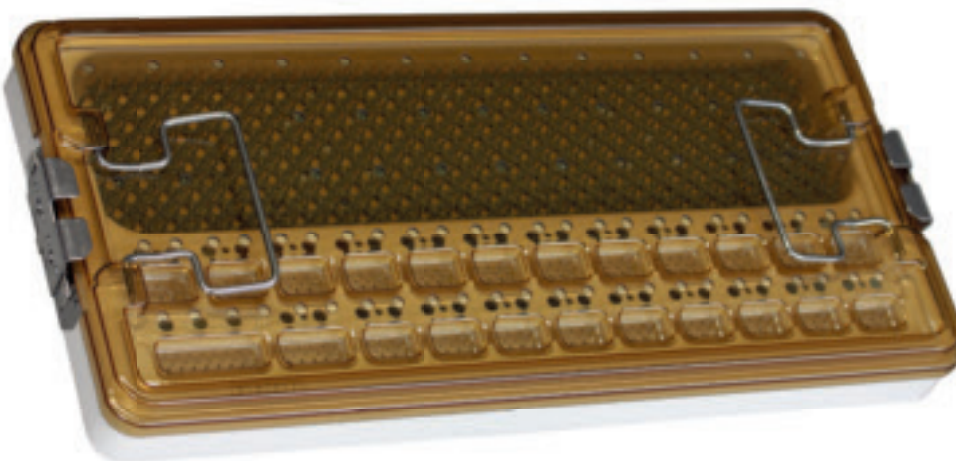
 Clip Lagerungstray aus PPSU mit 58 Fächern zur Aufnahme
 von Aneurysmen-Clips, sterilisierbar

storage tray for 58 aneurysm clips, made of PPSU, for sterilisation

Artikel-Nr.
Cat. No.

06-20-022

Maße
Measurements

528 x 254 x 40 mm

 Clip Lagerungstray aus PPSU mit 23 Fächern zur Aufnahme
 von Aneurysmen-Clips und Anlegezangen, sterilisierbar

*storage tray for 23 aneurysm clips and applying forceps,
 made of PPSU, for sterilisation*

Kennzeichnung
Identification

Die Kennzeichnungsschilder für die Clip Lagerungstrays 06-20-002 und 06-20-022 ermöglichen eine einfache Identifikation und erleichtern das Einsortieren der Aneurysmen Clips.

Die Schilder für permanente STANDARD Clips sind **blau**, für permanente MINI Clips **pink** codiert. Für temporäre Clips sind die Schilder **gelb** codiert.

Identification tags for clip storage trays 06-20-002 and 06-20-022 allow a simple identification and help by sorting the aneurysm clips into the tray.

*The tags for permanent STANDARD clips are **blue** and for permanent MINI clips **pink** coded. The tags for temporary clips are **yellow** coded.*

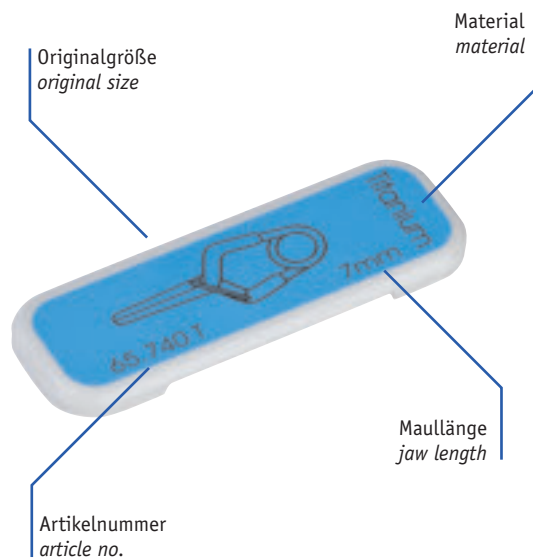

4

Artikel-Nr.
Cat. No.

65 000	Kennzeichnungsschild für Clip Lagerungstray 06-20-002 und 06-20-022 <i>identification tag for clips storage trays 06-20-002 and 06-20-022</i>
---------------	--

Bei Bestellung von Kennzeichnungsschildern bitte zusätzlich die Artikelnummer des Clips angeben.

When placing the order for identification tag, please add the article number of the clip.

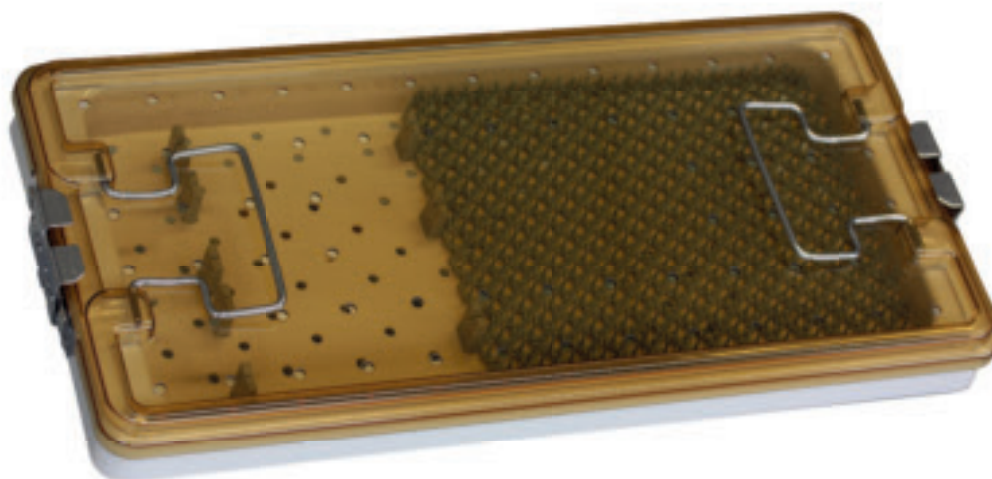

Artikel-Nr.
Cat. No.

Maße
Measurements

06-20-007	528 x 254 x 40 mm Lagerungstray aus PPSU für Clipanlagezangen und Instrumente, sterilisierbar <i>storage tray for clip applicators and instruments, made of PPSU, for sterilisation</i>
------------------	---

Artikel-Nr.
Cat. No.

06-55-010

Maße
Measurements

150 x 95 x 13 mm

Lagerungstray aus Edelstahl mit 18 Unterteilungen zur Aufnahme von Aneurysmen-Clips

storage tray made of stainless steel, with space for 18 aneurysm clips

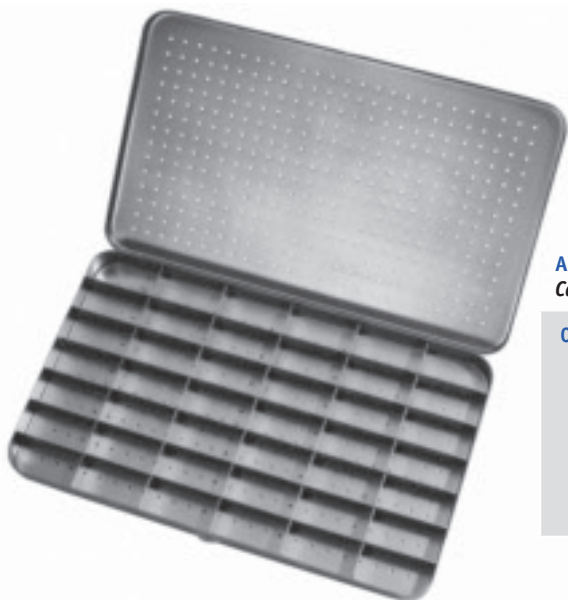
Artikel-Nr.
Cat. No.

06-55-011

Maße
Measurements

210 x 125 x 17 mm

Lagerungstray aus Edelstahl mit 42 Unterteilungen zur Aufnahme von Aneurysmen-Clips

storage tray made of stainless steel, with space for 42 aneurysm clips

Area with horizontal lines for notes.





Mikro-Neurochirurgische Instrumente
Micro-Neurosurgical Instruments

HF-Instrumente und Zubehör
HF Instruments and Accessoires

Kopf-Schädelinstrumente und Haltesysteme
Head-Cranio Instruments and Holding Systems

Aneurysmen-Clip System
Aneurysm Clip System

Schädel-Verplattung
Cranial Plate System



Hypophysektomie-Instrumente
Pituitary Instruments

Instrumente für die Wirbelsäule, Wundspreizer
Spine Instruments, Self-retaining Retractors

Laminektomie-Stanzen, Rongeurs, Hohlmeißelzangen
Laminectomy Punches, Rongeurs

Gefäß- und Bulldogklemmen, Gefäß-Clips
Vessel- and Bulldog-Clamps, Vessel Clips

Allgemeinchirurgische Instrumente
General Surgical Instruments

Alphabetischer Index, Numerischer Index
Alphabetical Index, Numerical Index

/// 05

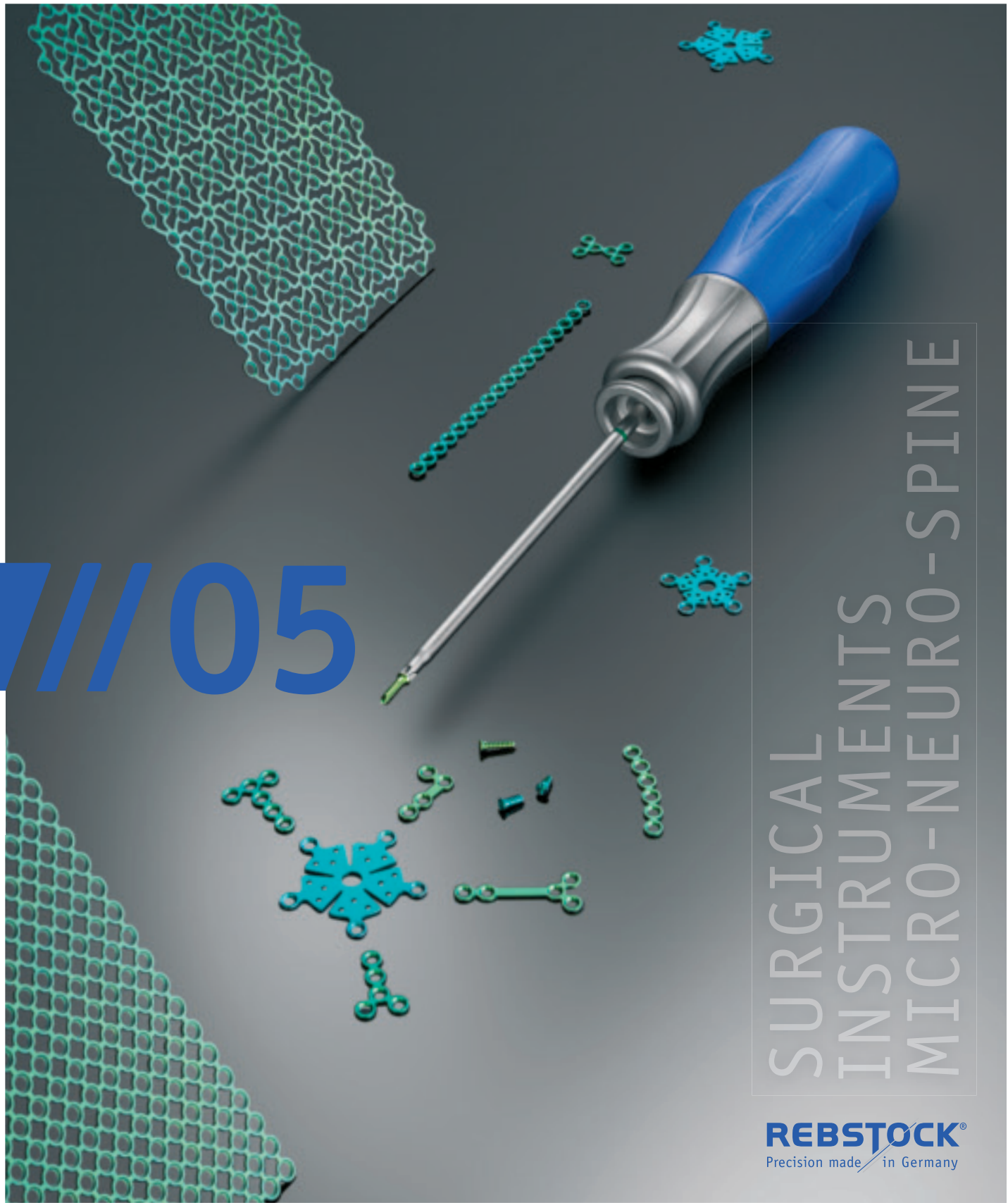

SURGICAL
INSTRUMENTS
MICRO-NEURO-SPINE

REBSTOCK®
Precision made in Germany

/// Schädel-Verplattung
Cranial Plate System

/// 05



SURGICAL
INSTRUMENTS
MICRO-NEURO-SPINE

REBSTOCK®
Precision made in Germany



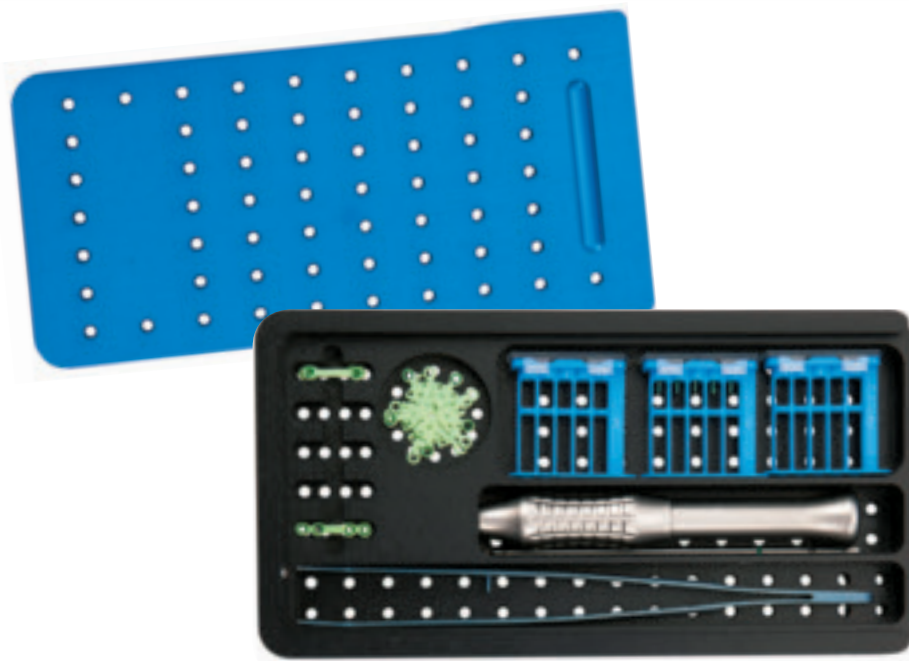



/// Schädel-Verplattung
Cranial Plate System

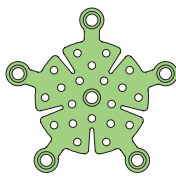

Artikel-Nr.
 Cat. No.

50-31-011	Schädel-Verplattungs-Set zur Fixierung der Knochendeckel, komplett, bestehend aus: <i>Cranio Plate Set for fixation of cranio lids, complete, consisting of:</i>
50-31-015	1x Rack mit Deckel, 170 x 90 x 25 mm, für Instrumente und Implantate <i>rack with lid, 170 x 90 x 25 mm, for instruments and implants</i>
50-31-505	1x Platten-/Schrauben-Haltepinzette, 150 mm, abgewinkelt, TITAN <i>plate and screw holding forceps, 150 mm, angled, TITANIUM</i>
50-31-510	1x Schraubendreher, selbsthaltend, 180 mm, für Kreuzschlitzschrauben <i>screwdriver, self-holding, 180 mm, for cross head screws</i>
50-31-101	1x Medium Platte, mit Steg, TITAN 1,6 mm x 0,6 mm, 2-Loch, VE = 5 Stück <i>medium plate, TITANIUM 1.6 mm x 0.6 mm, 2 holes, pack. of 5 pcs.</i>
50-31-102	1x Medium Platte, mit Steg, TITAN 1,6 mm x 0,6 mm, 2-Loch, VE = 5 Stück <i>medium plate, TITANIUM 1.6 mm x 0.6 mm, 2 holes, pack. of 5 pcs.</i>
50-31-139	3x Medium Bohrlochplatte, TITAN 1,6 mm x 0,6 mm, ø 15 mm <i>medium burr hole plate, TITANIUM 1.6 mm x 0.6 mm, ø 15 mm</i>
50-31-352	3x Medium Schraube, TITAN, Kreuzschlitz, 1,6 mm x 4 mm, selbstbohrend, VE = 5 Stück <i>medium screw, TITANIUM, cross head, 1.6 mm x 4 mm, self drilling, pack. of 5 pcs.</i>

Medium-Platten 1,6 mm, Profil 0,6 mm, TITAN
Medium Plates 1.6 mm, Profile 0.6 mm, TITANIUM
Artikel-Nr.
Cat. No.

1/1		50-31-101	Medium Platte, mit Steg, TITAN 2-Loch, VE = 5 Stück <i>medium plate, TITANIUM 2 holes, pack. of 5 pcs.</i>
1/1		50-31-102	Medium Platte, mit Steg, TITAN 2-Loch, VE = 5 Stück <i>medium plate, TITANIUM 2 holes, pack. of 5 pcs.</i>
1/1		50-31-139	Medium Bohlochplatte, TITAN ø 15 mm <i>medium burr hole plate, TITANIUM ø 15 mm</i>
2/1	  	50-31-352	Medium Schraube, Kreuzschlitz, TITAN 1,6 mm x 4 mm, selbstbohrend, VE = 5 Stück <i>medium screw, cross head, TITANIUM 1.6 mm x 4 mm, self drilling, pack. of 5 pcs.</i>

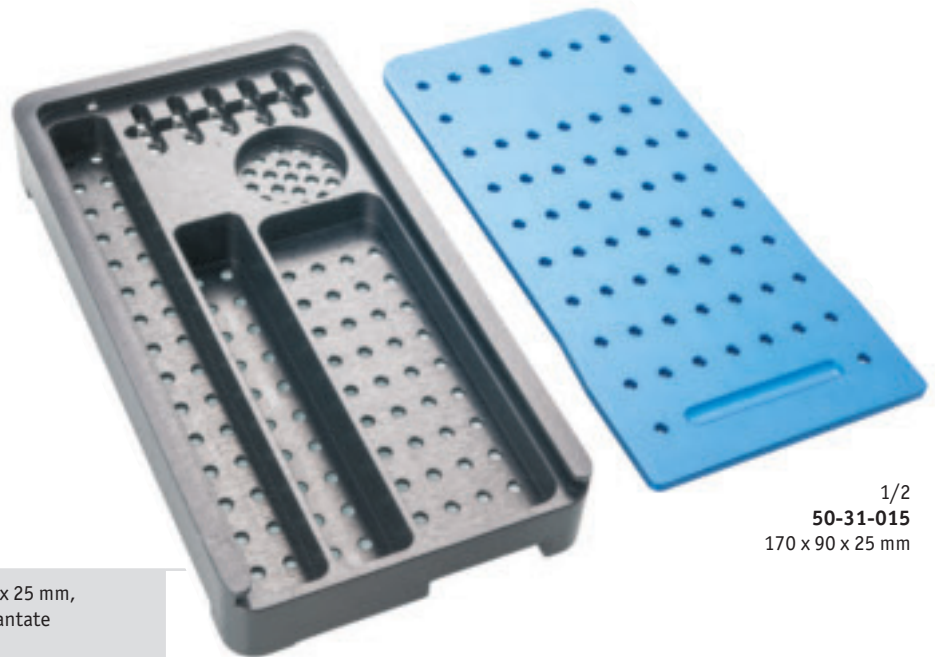

Artikel-Nr.
Cat. No.

1/2
50-31-015
 170 x 90 x 25 mm

50-31-015 Rack mit Deckel, 170 x 90 x 25 mm,
 für Instrumente und Implantate
*rack with lid, 170 x 90 x 25 mm,
 for instruments and implants*



5

Artikel-Nr.
Cat. No.

Gesamtlänge
Total length

50-31-505 150 mm / 6"
 Platten-/Schrauben-Haltepinzette,
 abgewinkelt, TITAN
*plate and screw holding forceps,
 angled, TITANIUM*



1/2
50-31-505
 150 mm
 6"

Artikel-Nr.
Cat. No.

Gesamtlänge
Total length

50-31-510 180 mm / 7"
 Schraubendreher, selbsthaltend,
 für Kreuzschlitzschrauben
*screwdriver, self-holding,
 for cross head screws*



1/2
50-31-510
 180 mm
 7"



Artikel-Nr.
Cat. No.

50-31-000

Medium-Platten Standard Set für die Neurochirurgie
Standard Set Medium Plate for Neurosurgery

Inhalt Set siehe Seite 215.
Content of the set see page 215.

Artikel-Nr.
Cat. No.

50-31-000	Medium-Platten Standard Set für die Neurochirurgie, bestehend aus: <i>Standard Set Medium Plate for Neurosurgery, consisting of:</i>	
50-31-001	1x	Sterilisier-Container 300 x 200 x 70 mm <i>sterilisation container 300 x 200 x 70 mm</i>
50-31-002	1x	Rack für Instrument <i>rack for instruments</i>
50-31-003	1x	Rack für Platten und Schrauben <i>rack for plates and screws</i>
50-31-501	1x	Plattenschneidezange, 120 mm, TC <i>plate cutting forceps, 120 mm, TC</i>
50-31-502	1x	Flachzange, 135 mm <i>flat pliers, 135 mm</i>
50-31-503	1x	ADERER Plattenbiegezange, 130 mm <i>ADERER plate bending pliers, 130 mm</i>
50-31-505	1x	Platten-/Schrauben-Haltepinzette, 150 mm, abgewinkelt, TITAN <i>plate and screw holding forceps, 150 mm, angled, TITANIUM</i>
50-31-510	1x	Schraubendreher, selbsthaltend, 180 mm für Kreuzschlitzschrauben <i>screwdriver, self-holding, 180 mm for cross head screws</i>
50-31-525	1x	Spiralbohrer ø 1,3 mm x 47 mm, mit Stryker Ansatz <i>twist drill ø 1.3 mm x 47 mm, with Stryker coupling</i>
50-31-526	1x	Spiralbohrer ø 1,3 mm x 50 mm, mit Stryker Ansatz <i>twist drill ø 1.3 mm x 50 mm, with Stryker coupling</i>
50-31-101	1x	Medium Platte, mit Steg, TITAN 2-Loch / VE = 5 Stück <i>plate, straight with bar, 2-holes / pack. of 5 pcs.</i>
50-31-102	1x	Medium Platte, mit Steg, TITAN 2-Loch / VE = 5 Stück <i>plate, straight with bar, 2-holes / pack. of 5 pcs.</i>
50-31-104	1x	Medium Platte, mit Steg, TITAN 4-Loch / VE = 5 Stück <i>plate, straight with bar, 4-holes / pack. of 5 pcs.</i>
50-31-105	1x	Medium Platte, mit Steg, TITAN 4-Loch / VE = 5 Stück <i>plate, straight with bar, 4-holes / pack. of 5 pcs.</i>
50-31-106	1x	Medium Platte, mit Steg, TITAN 4-Loch / VE = 5 Stück <i>plate, straight with bar, 4-holes / pack. of 5 pcs.</i>
50-31-129	1x	Y-Platte mit Steg, 5-Loch / VE = 5 Stück <i>Y-plate with bar, 5-holes / pack. of 5 pcs.</i>
50-31-132	1x	Doppel-Y-Platte mit Steg, 6-Loch / VE = 5 Stück <i>double-Y-plate with bar, 6-holes / pack. of 5 pcs.</i>
50-31-141	1x	Rechteckplatte, 4-Loch / VE = 5 Stück <i>square-plate, 4-holes / pack. of 5 pcs.</i>
50-31-143	1x	Rechteckplatte, 3 x 2-Loch / VE = 5 Stück <i>square-plate, 3 x 2 holes / pack. of 5 pcs.</i>
50-31-145	1x	Rechteckplatte, 4 x 2-Loch / VE = 5 Stück <i>square-plate, 4 x 2 holes / pack. of 5 pcs.</i>
50-31-138	5x	Bohrlochplatte, ø 11,5 mm <i>burr hole plate, ø 11.5 mm</i>
50-31-139	5x	Bohrlochplatte, ø 15 mm <i>burr hole plate, ø 15 mm</i>
50-31-140	5x	Bohrlochplatte, ø 18 mm <i>burr hole plate, ø 18 mm</i>
50-31-158	5x	Bohrlochplatte, mit Drainage, ø 11,5 mm <i>burr hole plate, with drainage, ø 11.5 mm</i>
50-31-159	5x	Bohrlochplatte, mit Drainage, ø 15 mm <i>burr hole plate, with drainage, ø 15 mm</i>
50-31-160	5x	Bohrlochplatte, mit Drainage, ø 18 mm <i>burr hole plate, with drainage, ø 18 mm</i>
50-31-351	2x	Medium Schraube, Kreuzschlitz, 1,6 mm x 3 mm, selbstbohrend, VE = 5 Stück <i>medium screw, cross head, 1.6 mm x 3 mm, self drilling, pack. of 5 pcs.</i>
50-31-352	2x	Medium Schraube, Kreuzschlitz, 1,6 mm x 4 mm, selbstbohrend, VE = 5 Stück <i>medium screw, cross head, 1.6 mm x 4 mm, self drilling, pack. of 5 pcs.</i>
50-31-353	2x	Medium Schraube, Kreuzschlitz, 1,6 mm x 5 mm, selbstbohrend, VE = 5 Stück <i>medium screw, cross head, 1.6 mm x 5 mm, self drilling, pack. of 5 pcs.</i>
50-31-304	2x	Medium Schraube, Kreuzschlitz, 1,6 mm x 6 mm, selbstschneidend, VE = 5 Stück <i>medium screw, cross head, 1.6 mm x 6 mm, self tapping, pack. of 5 pcs.</i>















Medium-Platten 1,6 mm, Profil 0,6 mm, TITAN
 Medium Plates 1.6 mm, Profile 0.6 mm, TITANIUM

TITAN

5

Verpackungseinheit/VE = 5 Stück / packing unit 5 pcs.

 Artikel-Nr.
 Cat. No.

1/1		50-31-101	Platte, gerade mit Steg, 2-Loch plate, straight with bar, 2-holes
1/1		50-31-102	Platte, gerade mit Steg, 2-Loch plate, straight with bar, 2-holes
1/1		50-31-103	Platte, gerade, 4-Loch plate, straight, 4-holes
1/1		50-31-104	Platte, gerade mit Steg, 4-Loch plate, straight with bar, 4-holes
1/1		50-31-105	Platte, gerade mit Steg, 4-Loch plate, straight with bar, 4-holes
1/1		50-31-106	Platte, gerade mit Steg, 4-Loch plate, straight with bar, 4-holes
1/1		50-31-107	Platte, gerade, 6-Loch plate, straight, 6-holes
1/1		50-31-108	Platte, gerade mit Steg, 6-Loch plate, straight with bar, 6-holes
1/1		50-31-109	Platte, gerade, 8-Loch plate, straight, 8-holes
1/1		50-31-161	Platte, gerade, 12-Loch plate, straight, 12-holes
1/1		50-31-110	Platte, gerade, 16-Loch plate, straight, 16-holes
1/1		50-31-111	Platte, gerade, 18-Loch plate, straight, 18-holes
1/1		50-31-112	Platte, gerade, 30-Loch plate, straight, 30-holes







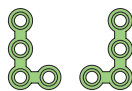

Medium-Platten 1,6 mm, Profil 0,6 mm, TITAN
Medium Plates 1.6 mm, Profile 0.6 mm, TITANIUM

TITAN

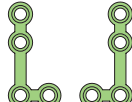
5

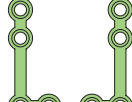
Verpackungseinheit/VE = 5 Stück / packing unit 5 pcs.

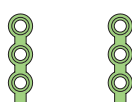
Artikel-Nr.
Cat. No.

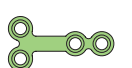
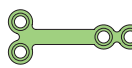
50-31-113	L-Platte, 4-Loch, rechts <i>L-plate, 4-holes, right</i>	1/1 
50-31-114	L-Platte, 4-Loch, links <i>L-plate, 4-holes, left</i>	
50-31-115	L-Platte mit Steg, 4-Loch, rechts <i>L-plate with bar, 4-holes, right</i>	1/1 
50-31-116	L-Platte mit Steg, 4-Loch, links <i>L-plate with bar, 4-holes, left</i>	
50-31-117	L-Platte mit Steg, 4-Loch, rechts <i>L-plate with bar, 4-holes, right</i>	1/1 
50-31-118	L-Platte mit Steg, 4-Loch, links <i>L-plate with bar, 4-holes, left</i>	
50-31-119	L-Platte mit Steg, 4-Loch, rechts <i>L-plate with bar, 4-holes, right</i>	1/1 
50-31-120	L-Platte mit Steg, 4-Loch, links <i>L-plate with bar, 4-holes, left</i>	
50-31-121	L-Platte mit Steg, 5-Loch, rechts <i>L-plate with bar, 5-holes, right</i>	1/1 
50-31-122	L-Platte mit Steg, 5-Loch, links <i>L-plate with bar, 5-holes, left</i>	
50-31-123	T-Platte mit Steg, 4-Loch <i>T-plate with bar, 4-holes</i>	1/1 
50-31-124	T-Platte mit Steg, 4-Loch <i>T-plate with bar, 4-holes</i>	1/1 



Medium-Platten 1,6 mm, Profil 0,6 mm, TITAN
 Medium Plates 1.6 mm, Profile 0.6 mm, TITANIUM

TITAN

5

Verpackungseinheit/VE = 5 Stück / packing unit 5 pcs.

 Artikel-Nr.
 Cat. No.

1/1		50-31-125	T-Platte, 6-Loch <i>T-plate, 6-holes</i>
1/1		50-31-126	T-Platte mit Steg, 5-Loch <i>T-plate with bar, 5-holes</i>
1/1		50-31-127	Doppel-T-Platte, 6-Loch <i>double T-plate, 6-holes</i>
1/1		50-31-128	Y-Platte, 5-Loch <i>Y-plate, 5-holes</i>
1/1		50-31-162	Y-Platte mit Steg, 5-Loch <i>Y-plate with bar, 5-holes</i>
1/1		50-31-129	Y-Platte mit Steg, 5-Loch <i>Y-plate with bar, 5-holes</i>
1/1		50-31-130	Y-Platte mit Steg, 5-Loch <i>Y-plate with bar, 5-holes</i>







Medium-Platten 1,6 mm, Profil 0,6 mm, TITAN
 Medium Plates 1.6 mm, Profile 0.6 mm, TITANIUM

TITAN

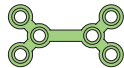
5

Verpackungseinheit/VE = 5 Stück / packing unit 5 pcs.



Artikel-Nr.
 Cat. No.

50-31-131	Doppel-Y-Platte, 6-Loch <i>double Y-plate, 6-holes</i>	1/1 
50-31-132	Doppel-Y-Platte mit Steg, 6-Loch <i>double Y-plate with bar, 6-holes</i>	1/1 
50-31-133	Doppel-Y-Platte, 7-Loch <i>double Y-plate, 7-holes</i>	1/1 
50-31-134	Orbita Platte, 4-Loch <i>orbita plate, 4-holes</i>	1/1 
50-31-135	Orbita Platte, 6-Loch <i>orbita plate, 6-holes</i>	1/1 
50-31-136	Orbita Platte, 8-Loch <i>orbita plate, 8-holes</i>	1/1 
50-31-137	Orbita Platte, 10-Loch <i>orbita plate, 10-holes</i>	1/1 

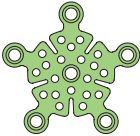
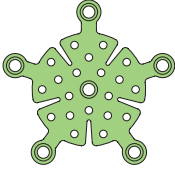
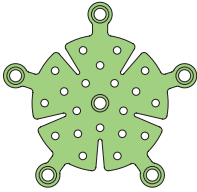

5

Bohrlochplatten für Trepanation
Burr hole plates for Trepanation
TITAN
1 Verpackungseinheit/VE = 1 Stück / packing unit 1 pcs.

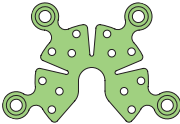
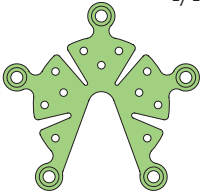
	Artikel-Nr. Cat. No.	
1/1 	50-31-138	Bohrlochplatte, ø 11,5 mm <i>burr hole plate, ø 11.5 mm</i>
1/1 	50-31-139	Bohrlochplatte, ø 15 mm <i>burr hole plate, ø 15 mm</i>
1/1 	50-31-140	Bohrlochplatte, ø 18 mm <i>burr hole plate, ø 18 mm</i>
1/1 	50-31-158	Bohrlochplatte, mit Drainage, ø 11,5 mm <i>burr hole plate, with drainage, ø 11.5 mm</i>
1/1 	50-31-159	Bohrlochplatte, mit Drainage, ø 15 mm <i>burr hole plate, with drainage, ø 15 mm</i>
1/1 	50-31-160	Bohrlochplatte, mit Drainage, ø 18 mm <i>burr hole plate, with drainage, ø 18 mm</i>



Medium-Platten 1,6 mm, Profil 0,6 mm, TITAN
Medium Plates 1.6 mm, Profile 0.6 mm, TITANIUM

TITAN

5

Verpackungseinheit/VE = 5 Stück / packing unit 5 pcs.

Artikel-Nr.
Cat. No.

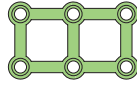
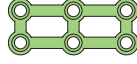
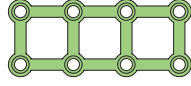
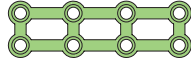
50-31-141	Rechteckplatte, 4-Loch <i>square plate, 4-holes</i>	1/1 
50-31-142	Rechteckplatte, 4-Loch <i>square plate, 4-holes</i>	1/1 
50-31-143	Rechteckplatte, 3 x 2-Loch <i>square plate, 3 x 2-holes</i>	1/1 
50-31-144	Rechteckplatte, 3 x 2-Loch <i>square plate, 3 x 2-holes</i>	1/1 
50-31-145	Rechteckplatte, 4 x 2-Loch <i>square plate, 4 x 2-holes</i>	1/1 
50-31-146	Rechteckplatte, 4 x 2-Loch <i>square plate, 4 x 2-holes</i>	1/1 



5

Medium-Platten 1,6 mm, Profil 0,6 mm, TITAN
 Medium Plates 1.6 mm, Profile 0.6 mm, TITANIUM

TITAN

1 Verpackungseinheit/VE = 1 Stück / packing unit 1 pcs.

Artikel-Nr.
 Cat. No.

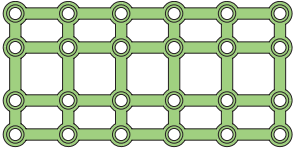
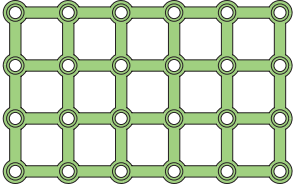
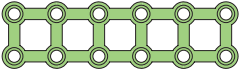
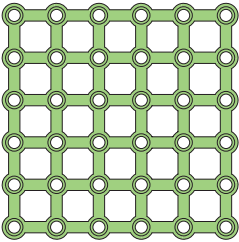
1/1	50-31-147	Rechteckplatte, 6 x 4-Loch square plate, 6 x 4-holes
		
1/1	50-31-148	Rechteckplatte, 6 x 4-Loch square plate, 6 x 4-holes
		
1/1	50-31-163	Rechteckplatte, 6 x 2-Loch square plate, 6 x 2-holes
		
1/1	50-31-164	Rechteckplatte, 6 x 6-Loch square plate, 6 x 6-holes
		

Medium-Platten 1,6 mm, Profil 0,6 mm, TITAN
 Medium Plates 1.6 mm, Profile 0.6 mm, TITANIUM

TITAN

1 Verpackungseinheit/VE = 1 Stück / packing unit 1 pcs.

Artikel-Nr.
 Cat. No.

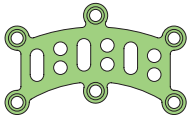
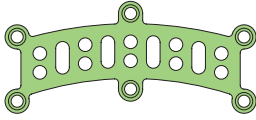
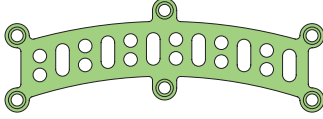
50-31-149	Neuro-Spaltenplatte <i>neuro gap plate</i>	1/1 
50-31-150	Neuro-Spaltenplatte <i>neuro gap plate</i>	1/1 
50-31-151	Neuro-Spaltenplatte <i>neuro gap plate</i>	1/1 

Artikel-Nr.
 Cat. No.

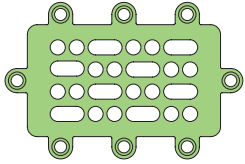
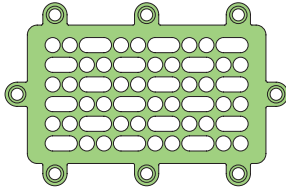
50-31-152	Neuro-Sub-temporale Platte <i>neuro sub temporal plate</i>	1/1 
50-31-153	Neuro-Sub-temporale Platte <i>neuro sub temporal plate</i>	1/1 

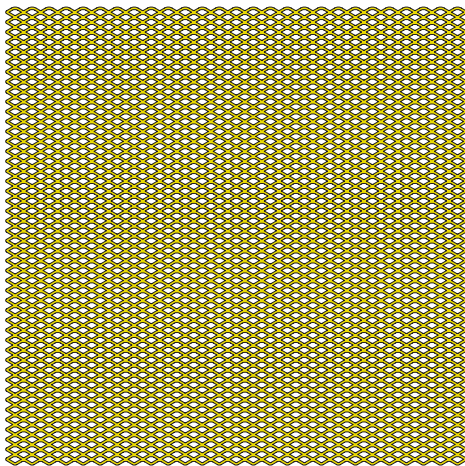

Gitter-Platten, TITAN
Mesh Plates, TITANIUM
TITAN
1 Verpackungseinheit/VE = 1 Stück / packing unit 1 pcs.

Artikel-Nr.
Cat. No.
Maße
Measurement

50-31-251

60 x 60 x 0,1 mm

50-31-252

120 x 60 x 0,1 mm

50-31-253

120 x 120 x 0,1 mm

50-31-254

60 x 60 x 0,2 mm

50-31-255

120 x 60 x 0,2 mm

50-31-256

120 x 120 x 0,2 mm

Artikel-Nr.
Cat. No.
Maße
Measurement

50-31-257

80 x 50 x 0,3 mm

50-31-258

80 x 50 x 0,6 mm

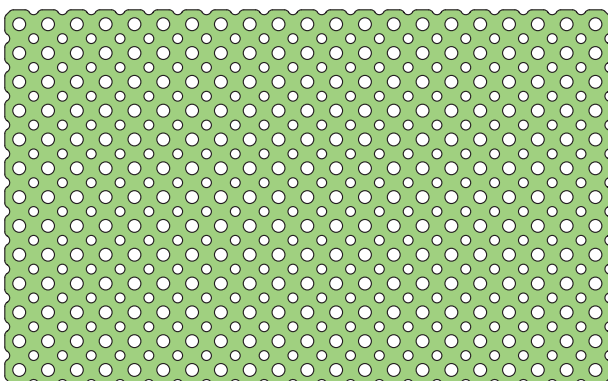

Gitter-Platten, TITAN
Mesh Plates, TITANIUM

TITAN

1 Verpackungseinheit/VE = 1 Stück / packing unit 1 pcs.

Artikel-Nr. Cat. No.	Maße Measurement
50-36-200	40 x 60 x 0,3 mm
50-36-201	50 x 70 x 0,3 mm
50-36-202	60 x 80 x 0,3 mm
50-36-203	70 x 90 x 0,3 mm
50-36-204	90 x 90 x 0,3 mm
50-36-100	40 x 60 x 0,6 mm
50-36-101	50 x 70 x 0,6 mm
50-36-102	60 x 80 x 0,6 mm
50-36-103	70 x 90 x 0,6 mm
50-36-104	90 x 90 x 0,6 mm
50-36-105	80 x 120 x 0,6 mm
50-36-106	90 x 120 x 0,6 mm
50-36-107	100 x 120 x 0,6 mm
50-36-108	120 x 120 x 0,6 mm
50-36-109	100 x 150 x 0,6 mm
50-36-110	120 x 150 x 0,6 mm
50-36-111	150 x 150 x 0,6 mm
50-36-112	150 x 200 x 0,6 mm

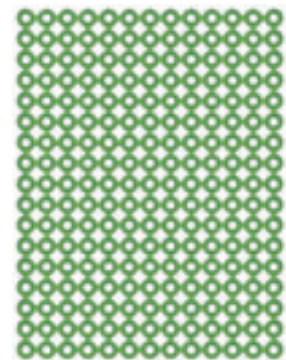

5

Artikel-Nr. Cat. No.	Maße Measurement
50-36-240	40 x 60 x 0,3 mm
50-36-244	90 x 90 x 0,3 mm
50-36-140	40 x 60 x 0,6 mm
50-36-144	90 x 90 x 0,6 mm
50-36-148	120 x 120 x 0,6 mm
50-36-152	150 x 200 x 0,6 mm

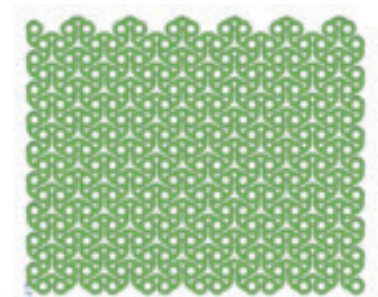

Medium-Knochenschrauben 1,6 mm, TITAN
Medium Bone Screws, 1.6 mm, TITANIUM

TITAN

5

Verpackungseinheit/VE = 5 Stück / packing unit 5 pcs.



Schrauben im handlichen Spendermagazin zur Direktentnahme. Sterilisierbar im Autoklav bei 134° C.
 In convenient dispenser unit for direct extraction. Sterilizable in the vacuum autoclave with 134 °C.

Kreuzschlitz-Schrauben
Cross Head Screws

2/1

Selbstschneidend Self cutting	Selbstbohrend Self drilling	∅	Länge Length
50-31-301	50-31-351	1,6 mm	3 mm
50-31-302	50-31-352	1,6 mm	4 mm
50-31-303	50-31-353	1,6 mm	5 mm
50-31-304		1,6 mm	6 mm
50-31-305		1,6 mm	7 mm
50-31-306		1,6 mm	8 mm

Notfallschrauben, Kreuzschlitz
Emergency Screws, Cross Head

2/1

	∅	Länge Length
50-31-307	1,9 mm	5 mm

Instrumente für Medium-Platten System 1,6 mm
 Instruments for Medium Plate System 1.6 mm

TC

Artikel-Nr. Cat. No.	Gesamtlänge Total length
50-31-501	120 mm / 4¾"
	Plattenschneidezange, TC plate cutting pliers, TC



2/3
 50-31-501
 120 mm
 4¾"

Artikel-Nr. Cat. No.	Gesamtlänge Total length
50-31-502	135 mm / 5¼"
	Flachzange flat pliers



2/3
 50-31-502
 135 mm
 5¼"

Artikel-Nr. Cat. No.	Gesamtlänge Total length	ADERER
50-31-503	130 mm / 5⅛"	
	Plattenbiegezange plate bending pliers	



2/3
 ADERER
 50-31-503
 130 mm
 5⅛"



Instrumente für Medium-Platten System 1,6 mm
Instruments for Medium Plate System 1.6 mm

 2/3
50-31-505
 150 mm
 6"

TITAN
Artikel-Nr.
Cat. No.
Gesamtlänge
Total length
50-31-505

150 mm / 6"

 Platten-/Schrauben-Haltepinzette,
 abgewinkelt, TITAN

plate and screw holding forceps,
angled, TITANIUM

Artikel-Nr. Cat. No.	Gesamtlänge Total length
50-31-505	150 mm / 6"

 2/3
04-16-551
 120 mm
 4¾"

TC
Artikel-Nr.
Cat. No.
Gesamtlänge
Total length

1/1

04-16-552

120 mm / 4¾"

 Draht-/Blechscherer, TC
wire cutting scissors, TC

Artikel-Nr. Cat. No.	Gesamtlänge Total length
04-16-552	120 mm / 4¾"

Instrumente für Medium-Platten System 1,6 mm
 Instruments for Medium Plate System 1.6 mm

Artikel-Nr. Cat. No.	Gesamtlänge Total length	
50-31-507	180 mm / 7"	1/1
	Schraubendreher komplett, selbsthaltend für Kreuzschlitzschrauben <i>screwdriver complete, self-holding for cross drive screws</i>	

1/2
 50-31-507
 180 mm
 7"



5

Artikel-Nr. Cat. No.		
50-31-509	Schraubendrehergriff allein, für alle Schraubendreherklingen <i>screwdriver handle alone for screwdriver blades</i>	

1/2
 50-31-509



Artikel-Nr. Cat. No.	Gesamtlänge Total length	
50-31-510	180 mm / 7"	1/1
	Schraubendreher komplett, selbsthaltend für Kreuzschlitzschrauben <i>screwdriver complete, self-holding for cross head screws</i>	

1/2
 50-31-510
 180 mm
 7"



Instrumente für Medium-Platten System 1,6 mm
Instruments for Medium Plate System 1.6 mm

 1/2
 50-31-513

Artikel-Nr.
Cat. No.
50-31-513

 Schraubendrehergriff allein,
 für alle Schraubendreherklingen

*screwdriver handle alone,
 for screwdriver blades*

 1/2
 50-31-514

Artikel-Nr.
Cat. No.

1/1

50-31-514

 Schraubendreherklinge allein,
 selbsthaltend,
 für Kreuzschlitzschrauben

*screwdriver blade alone, self-holding,
 for cross head screws*

 1/2
 50-31-518

Artikel-Nr.
Cat. No.
50-31-518

 Tiefenmesser, Messtiefe 50 mm
depth gauge, measuring depth 50 mm

Instrumente für Medium-Platten System 1,6 mm
Instruments for Medium Plate System 1.6 mm

Artikel-Nr.
Cat. No.

	Spiralbohrer mit Stryker-Anschluss <i>Twist Drill with Stryker Coupling</i>
50-31-525	Spiralbohrer ø 1,3 x 47 mm für Schrauben bis 4 mm Länge <i>twist drill ø 1.3 x 47 mm for screws up to 4 mm length</i>
50-31-526	Spiralbohrer ø 1,3 x 50 mm für Schrauben bis 8 mm Länge <i>twist drill ø 1.3 x 50 mm for screws up to 8 mm length</i>

Artikel-Nr.
Cat. No.

	Spiralbohrer mit Dental-Anschluss <i>Twist Drill with Dental Coupling</i>
50-31-527	Spiralbohrer ø 1,3 x 31 mm für Schrauben bis 4 mm Länge <i>twist drill ø 1.3 x 31 mm for screws up to 4 mm length</i>
50-31-528	Spiralbohrer ø 1,3 x 34 mm für Schrauben bis 8 mm Länge <i>twist drill ø 1.3 x 34 mm for screws up to 8 mm length</i>





Mikro-Neurochirurgische Instrumente
Micro-Neurosurgical Instruments

HF-Instrumente und Zubehör
HF Instruments and Accessoires

Kopf-Schädelinstrumente und Haltesysteme
Head-Cranio Instruments and Holding Systems

Aneurysmen-Clip System
Aneurysm Clip System

Schädel-Verplattung
Cranial Plate System

Hypophysektomie-Instrumente *Pituitary Instruments*



Instrumente für die Wirbelsäule, Wundspreizer
Spine Instruments, Self-retaining Retractors

Laminektomie-Stanzen, Rongeure, Hohlmeißelzangen
Laminectomy Punches, Rongeurs

Gefäß- und Bulldogklemmen, Gefäß-Clips
Vessel- and Bulldog-Clamps, Vessel Clips

Allgemeinchirurgische Instrumente
General Surgical Instruments

Alphabetischer Index, Numerischer Index
Alphabetical Index, Numerical Index

/// 06

SURGICAL
INSTRUMENTS
MICRO-NEURO-SPINE

REBSTOCK®
Precision made in Germany

/// Hypophysektomie-Instrumente
Pituitary Instruments

/// www.rebstock.de



SURGICAL
INSTRUMENTS
MICRO-NEURO-SPINE

REBSTOCK
Precision made in Germany

/// Hypophysektomie-Instrumente
Pituitary Instruments

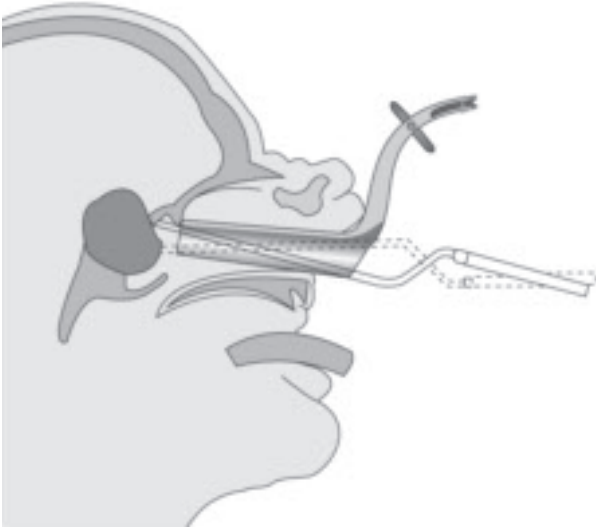

Artikel-Nr.
Cat. No.

Größe
Size

Artikel-Nr. Cat. No.	Größe Size		
15-11-100	70 x 15 mm	CUSHING- LANDOLT	
15-11-101	90 x 15 mm		
15-11-102	110 x 15 mm		
Spekula für transphenoidale Hypophysektomie <i>specula for transphenoidal hypophysectomy</i>			

1/2
CUSHING-LANDOLT
15-11-101
90 x 15 mm

Artikel-Nr.
Cat. No.

Gesamtlänge
Total length

Artikel-Nr. Cat. No.	Gesamtlänge Total length		
15-11-103	210 mm / 8¼"	LANDOLT	
Spreizzange zum Spreizen der Spekula 15-11-100 bis 15-11-102 <i>spreader for specula 15-11-100 to 15-11-102</i>			



1/2
LANDOLT
15-11-103
210 mm
8¼"

Standard Line

Oberfläche matt gebürstet
Surface polished

Beispiel-Artikel-Nr.
Example Cat. No. **15-11-103**

Black Line

Oberfläche schwarz, titanbeschichtet
Surface black, titanium-coated

Beispiel-Artikel-Nr.
Example Cat. No. **15-11-103B**

PAPAVERO-CASPAR
Artikel-Nr.
Cat. No.
Größe
Size
06-06-589
06-06-590
06-06-591

 80 x 11 mm
 90 x 13 mm
 100 x 13 mm

 Spekula für transphenoidale
 Hypophysektomie

specula for transphenoidal hypophysectomy
20-05-749

 Spanschlüssel für Spekula
 06-06-589 bis 06-06-591

key for specula
06-06-589 to 06-06-591

 1/2
PAPAVERO-CASPAR
06-06-590
 90 x 13 mm

1/2

PAPAVERO-HARTMANN
Artikel-Nr.
Cat. No.
06-06-595

 Spreizer für Spekula
 06-06-589 bis 06-06-591

spreader for specula
06-06-589 to 06-06-591

 1/2
PAPAVERO-HARTMANN
06-06-595

1/2

COTTLE
Artikel-Nr.
Cat. No.
Größe
Size
15-11-089
15-11-090

 80 x 7 mm
 90 x 7 mm

 Selbsthaltende Nasenspekula,
 als Einführungshilfe für Spekula
 06-06-589 bis 06-06-591

self-retaining nasal specula,
as introducer for 06-06-589 to 06-06-591

 1/2
COTTLE
15-11-090
 90 x 7 mm

Standard Line

 Oberfläche matt gebürstet
Surface polished

 Beispiel-Artikel-Nr.
Example Cat. No.
15-11-090
Black Line

 Oberfläche schwarz, titanbeschichtet
Surface black, titanium-coated

 Beispiel-Artikel-Nr.
Example Cat. No.
15-11-090B

Artikel-Nr. Cat. No.	Gesamtlänge Total length		
15-12-301	180 mm / 7" 4 mm		COTTLE
15-12-302	180 mm / 7" 6 mm		
15-12-303	180 mm / 7" 8 mm		
15-62-300	180 mm / 7" 10 mm		
15-12-304	180 mm / 7" 12 mm		
Osteotome, graduiert osteotomes, graduated			

1/2
COTTLE
15-12-301
 180 mm
 7"



Artikel-Nr. Cat. No.	Gesamtlänge Total length		
06-06-610	220 mm / 8¾" 4 mm breit 4 mm wide Meißel chisel		PAPAVERO
Meißel chisel			

1/2
PAPAVERO
06-06-610
 220 mm
 8¾"



Artikel-Nr. Cat. No.	Gesamtlänge Total length		
06-12-038	180 mm / 7" ø 30 mm, 240 g 1 Seite flach, 1 Seite convex 1 side flat, 1 side convex		COTTLE
1 Seite flach, 1 Seite convex 1 side flat, 1 side convex			

1/2
COTTLE
06-12-038
 180 mm
 7"





6





			Artikel-Nr. Cat. No.	Schaftlänge Length of shaft
1/1	FAHLBUSCH		06-04-220	165 mm / 6½" Mikro-Schere, gebogen, horizontal schneidend <i>micro scissors, curved, horizontal cutting</i>
1/1	NICOLA		06-04-226	165 mm / 6½" Mikro-Schere, gerade <i>micro scissors, straight</i>
1/1	CASPAR		06-04-228	165 mm / 6½" Mikro-Schere, gebogen <i>micro scissors, curved</i>
1/1	YASARGIL-NICOLA		06-04-222	165 mm / 6½" Löffelzange, gerade <i>spoon forceps, straight</i>
1/1	CASPAR		06-04-224	165 mm / 6½" Faßzange, gerade <i>grasping forceps, straight</i>

 1/2
CASPAR
06-04-226
 165 mm
 6½"



Artikel-Nr. Cat. No.	Gesamtlänge Total length		
06-04-083	215 mm / 8½"	LANDOLT	
	Schaftlänge 140 mm / 5½" length of shaft 140 mm / 5½"		

1/2
LANDOLT
06-04-083
215 mm
8½"

Artikel-Nr. Cat. No.	Gesamtlänge Total length		
06-74-645	135 mm / 5¼"	1/1 6 mm	
06-74-646	135 mm / 5¼"	1/1 8 mm	
06-74-647	135 mm / 5¼"	1/1 10 mm	
06-74-648	135 mm / 5¼"	1/1 12 mm	
	Alle Spiegel passend für Spiegelgriffe all mirrors for mirror handles 13-56-000, 13-56-100, 06-04-361, 06-54-361		



1/2
06-74-648
135 mm
5¼"

Griffe siehe Seite 240, 241
Handle see page 240, 241



2/3
06-04-361
 105 mm
 4 1/8"

Artikel-Nr.
Cat. No.

Gesamtlänge
Total length

06-04-361

105 mm / 4 1/8"

Metallgriff für auswechselbare
 Mikroschäfte, 360° drehbar

*metal handle for micro-shaft instruments,
 360° turnable*

Artikel-Nr.
Cat. No.

Gesamtlänge
Total length

06-54-361

155 mm / 6 1/4"

Kunststoffgriff für auswechselbare Mikro-
 schäfte, 360° drehbar, mit Gegengewicht

*plastic handle for micro-shaft instruments,
 360° turnable, with counter balance*

2/3
06-54-361
 155 mm
 6 1/4"

Artikel-Nr. Cat. No.	Gesamtlänge Total length
13-56-100	160 mm / 6¼"
Metallgriff für auswechselbare Mikroschäfte, bajonettförmig, in der Länge variabel einstellbar, 360° drehbar <i>metal handle, bayonet-shaped, for micro-shaft instruments, shaft length adjustable, 360° turnable</i>	

Artikel-Nr. Cat. No.	Gesamtlänge Total length
13-56-000	170 mm / 6¾"
Kunststoffgriff für auswechselbare Mikroschäfte, bajonettförmig, in der Länge variabel einstellbar, 360° drehbar, mit Gegengewicht <i>plastic handle, bayonet-shaped, for micro-shaft instruments, shaft length adjustable, 360° turnable, with counter balance</i>	



2/3
13-56-100
 160 mm
 6¼"

2/3
13-56-000
 170 mm
 6¾"

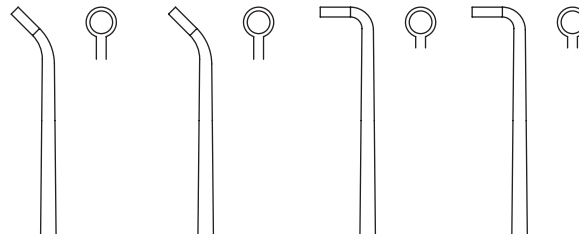

 1/1
13-06-117
 150 mm
 6"

**Mikroschaft
Küretten**
*Micro shaft
Currettes*

	45° gebogen, scharf 45° curved, sharp	45° gebogen, stumpf 45° curved, blunt	90° gebogen, scharf 90° curved, sharp	90° gebogen, stumpf 90° curved, blunt	Gesamtlänge Total length
ø 2 mm	13-06-121	13-06-112	13-06-125	13-06-116	150 mm / 6"
ø 3 mm	13-06-122	13-06-113	13-06-126	13-06-117	150 mm / 6"
ø 4 mm	13-06-123	13-06-114	13-06-127	13-06-118	150 mm / 6"
ø 5 mm	13-06-124	13-06-115	13-06-128	13-06-119	150 mm / 6"
ø 6 mm	13-56-124	13-56-115	16-56-128	13-06-120	150 mm / 6"

TITAN
**Mikroschaft
Küretten, TITAN**
*Micro shaft
Currettes, TITANIUM*

	45° gebogen, scharf 45° curved, sharp	45° gebogen, stumpf 45° curved, blunt	90° gebogen, scharf 90° curved, sharp	90° gebogen, stumpf 90° curved, blunt	Gesamtlänge Total length
ø 2 mm	13-06-121T	13-06-112T	13-06-125T	13-06-116T	150 mm / 6"
ø 3 mm	13-06-122T	13-06-113T	13-06-126T	13-06-117T	150 mm / 6"
ø 4 mm	13-06-123T	13-06-114T	13-06-127T	13-06-118T	150 mm / 6"
ø 5 mm	13-06-124T	13-06-115T	13-06-128T	13-06-119T	150 mm / 6"
ø 6 mm	13-56-124T	13-56-115T	13-56-128T	13-06-120T	150 mm / 6"

 Zur Verwendung mit den Griffen **13-56-000, 13-56-100, 06-04-361, 06-54-361**
 to use with handles **13-56-000, 13-56-100, 06-04-361, 06-54-361**



45° horizontal
45° horizontal



45° vertikal
45° vertical

Gesamtlänge
Total length

Küretten
Curettes

06-56-600	06-56-610	265 mm / 10½"	RAY	ø 3 mm
06-06-611	06-06-614	265 mm / 10½"	RAY	ø 4 mm
06-56-609	06-56-611	265 mm / 10½"	RAY	ø 5 mm



45° horizontal
45° horizontal



45° vertikal
45° vertical

Gesamtlänge
Total length

TITAN

Küretten, TITAN
Curettes, TITANIUM

06-56-600T	06-56-610T	265 mm / 10½"	RAY	ø 3 mm
06-06-611T	06-06-614T	265 mm / 10½"	RAY	ø 4 mm
06-56-609T	06-56-611T	265 mm / 10½"	RAY	ø 5 mm



6

1/1
RAY
06-06-611
180 mm
7½"



6

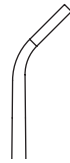

45°
gewinkelt,
langer Hals
45° angled,
long neck



45°
gewinkelt,
kurzer Hals
45° angled,
short neck

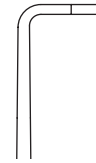

90°
gewinkelt,
langer Hals
90° angled,
long neck

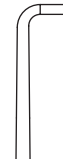

90°
gewinkelt,
kurzer Hals
90° angled,
short neck

Küretten, halbscharf
Curettes, semi-sharp

Gesamtlänge
Total length

Ø	Hersteller	06-51-001	06-51-006	06-51-010	06-51-013	Gesamtlänge
ø 2 mm	HARDY	06-51-001	06-51-006	06-51-010	06-51-013	265 mm / 10½"
ø 3 mm	HARDY	06-51-002	06-51-007	06-51-011	06-51-014	265 mm / 10½"
ø 4 mm	HARDY	06-51-003	06-01-036	06-01-034	06-01-035	265 mm / 10½"
ø 5 mm	HARDY	06-51-004	06-51-008	06-51-012	06-51-015	265 mm / 10½"
ø 6 mm	HARDY	06-51-005	06-51-009	06-01-037	06-01-038	265 mm / 10½"



45°vertikal gewinkelt,
beidseitig arbeitend
45°vertical angled,
working on both sides



45°horizontal gewinkelt
45°horizontal angled

Küretten, halbscharf
Curettes, semi-sharp

Gesamtlänge
Total length

Ø	Hersteller	06-01-030	06-01-031	Gesamtlänge
ø 6,5 mm	NICOLA	06-01-030	06-01-031	265 mm / 10½"

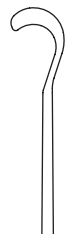

Enucleator
links
schneidend
Enucleator
left cutting



Enucleator
rechts
schneidend
Enucleator
right cutting



Mikro-
Häkchen
1,7 mm
Micro Hook
1.7 mm



Dissektor
stumpf
2,0 mm
Dissector
blunt
2.0 mm

Gesamtlänge
Total length

Hersteller	06-01-032	06-01-033	06-01-039	06-01-040	Gesamtlänge
HARDY	06-01-032	06-01-033			265 mm / 10½"
LANDOLT-REULEN			06-01-039	06-01-040	265 mm / 10½"

2/3
HARDY
06-01-034
265 mm
10½"

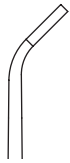

45°
gewinkelt,
langer Hals
45° angled,
long neck



45°
gewinkelt,
kurzer Hals
45° angled,
short neck

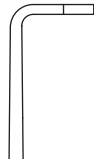

90°
gewinkelt,
langer Hals
90° angled,
long neck

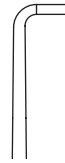

90°
gewinkelt,
kurzer Hals
90° angled,
short neck

Gesamtlänge
Total length

TITAN

Küretten, halbscharf, TITAN
Curettes, semi-sharp, TITANIUM

06-51-001T	06-51-006T	06-51-010T	06-51-013T	265 mm / 10½"	HARDY	ø 2 mm
06-51-002T	06-51-007T	06-51-011T	06-51-014T	265 mm / 10½"	HARDY	ø 3 mm
06-51-003T	06-01-036T	06-01-034T	06-01-035T	265 mm / 10½"	HARDY	ø 4 mm
06-51-004T	06-51-008T	06-51-012T	06-51-015T	265 mm / 10½"	HARDY	ø 5 mm
06-51-005T	06-51-009T	06-01-037T	06-01-038T	265 mm / 10½"	HARDY	ø 6 mm

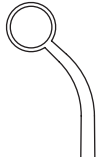

45°vertikal gewinkelt,
beidseitig arbeitend
45°vertical angled,
working on both sides



45°horizontal gewinkelt
45°horizontal angled

Gesamtlänge
Total length

TITAN

Küretten, halbscharf, TITAN
Curettes, semi-sharp, TITANIUM

06-01-030T	06-01-031T	265 mm / 10½"	NICOLA	ø 6,5 mm
------------	------------	---------------	--------	----------



Enukleator
links
schneidend
Enucleator
left cutting



Enukleator
rechts
schneidend
Enucleator
right cutting



Mikro-
Häkchen
1,7 mm
Micro Hook
1.7 mm



Dissektor
stumpf
2,0 mm
Dissector
blunt
2.0 mm

Gesamtlänge
Total length

TITAN

06-01-032T	06-01-033T			265 mm / 10½"	HARDY	
		06-01-039T	06-01-040T	265 mm / 10½"	LANDOLT- REULEN	



2/3
HARDY
06-01-034T
265 mm
10½"

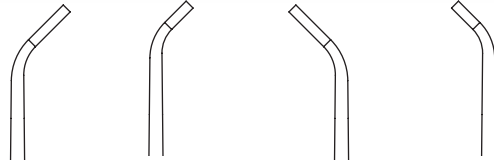

Küretten, halbscharf Curettes, semi-sharp		45° rechts, langer Hals 45° right, long neck	45° rechts, kurzer Hals 45° right, short neck	45° links, langer Hals 45° left, long neck	45° links, kurzer Hals 45° left, short neck	Gesamtlänge Total length
ø 2 mm	HARDY	06-51-016	06-51-021	06-51-025	06-51-030	280 mm / 11"
ø 3 mm	HARDY	06-51-017	06-51-022	06-51-026	06-51-031	280 mm / 11"
ø 4 mm	HARDY	06-51-018	06-01-062	06-51-027	06-01-061	280 mm / 11"
ø 5 mm	HARDY	06-51-019	06-51-023	06-51-028	06-51-032	280 mm / 11"
ø 6 mm	HARDY	06-51-020	06-51-024	06-51-029	06-51-033	280 mm / 11"

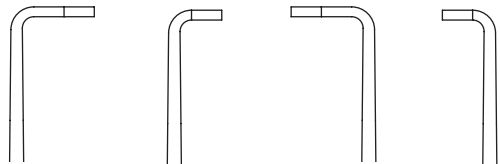

Küretten, halbscharf Curettes, semi-sharp		90° rechts, langer Hals 90° right, long neck	90° rechts, kurzer Hals 90° right, short neck	90° links, langer Hals 90° left, long neck	90° links, kurzer Hals 90° left, short neck	Gesamtlänge Total length
ø 2 mm	HARDY	06-51-034	06-51-037	06-51-040	06-51-043	280 mm / 11"
ø 3 mm	HARDY	06-51-035	06-51-038	06-51-041	06-51-044	280 mm / 11"
ø 4 mm	HARDY	06-01-047	06-01-060	06-01-045	06-01-046	280 mm / 11"
ø 5 mm	HARDY	06-51-036	06-51-039	06-51-042	06-51-045	280 mm / 11"
ø 6 mm	HARDY	06-01-065	06-01-066	06-01-063	06-01-064	280 mm / 11"



Küretten, halbscharf Curettes, semi-sharp		45° vertikal aufwärts ge- winkelt, beidseitig arbeitend 45° vertical angled up, working on both sides	45° horizontal aufwärts gewinkelt 45° horizontal angled up	Gesamtlänge Total length
ø 2 mm	HARDY	06-51-046	06-51-051	280 mm / 11"
ø 3 mm	HARDY	06-51-047	06-51-052	280 mm / 11"
ø 4 mm	HARDY	06-51-048	06-51-053	280 mm / 11"
ø 5 mm	HARDY	06-51-049	06-51-054	280 mm / 11"
ø 6 mm	HARDY	06-51-050	06-51-055	280 mm / 11"
ø 6,5 mm	NICOLA	06-01-041	06-01-042	280 mm / 11"

2/3
 HARDY
 06-01-045
 280 mm
 11"

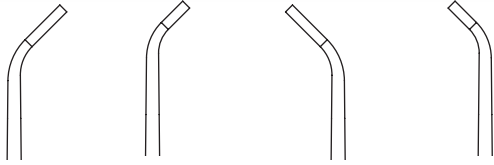

45° rechts, langer Hals
45° right, long neck

45° rechts, kurzer Hals
45° right, short neck

45° links, langer Hals
45° left, long neck

45° links, kurzer Hals
45° left, short neck

Gesamtlänge
Total length

TITAN
Küretten, halbscharf, TITAN
Curettes, semi-sharp, TITANIUM

06-51-016T	06-51-021T	06-51-025T	06-51-030T	280 mm / 11"	HARDY	ø 2 mm
06-51-017T	06-51-022T	06-51-026T	06-51-031T	280 mm / 11"	HARDY	ø 3 mm
06-51-018T	06-01-062T	06-51-027T	06-01-061T	280 mm / 11"	HARDY	ø 4 mm
06-51-019T	06-51-023T	06-51-028T	06-51-032T	280 mm / 11"	HARDY	ø 5 mm
06-51-020T	06-51-024T	06-51-029T	06-51-033T	280 mm / 11"	HARDY	ø 6 mm

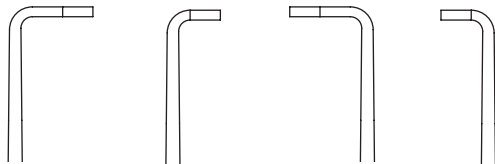

90° rechts, langer Hals
90° right, long neck

90° rechts, kurzer Hals
90° right, short neck

90° links, langer Hals
90° left, long neck

90° links, kurzer Hals
90° left, short neck

Gesamtlänge
Total length

TITAN
Küretten, halbscharf, TITAN
Curettes, semi-sharp, TITANIUM

06-51-034T	06-51-037T	06-51-040T	06-51-043T	280 mm / 11"	HARDY	ø 2 mm
06-51-035T	06-51-038T	06-51-041T	06-51-044T	280 mm / 11"	HARDY	ø 3 mm
06-01-047T	06-01-060T	06-01-045T	06-01-046T	280 mm / 11"	HARDY	ø 4 mm
06-51-036T	06-51-039T	06-51-042T	06-51-045T	280 mm / 11"	HARDY	ø 5 mm
06-01-065T	06-01-066T	06-01-063T	06-01-064T	280 mm / 11"	HARDY	ø 6 mm



45° vertikal aufwärts ge-
winkelt, beidseitig arbeitend
45° vertical angled up,
working on both sides

45° horizontal aufwärts
gewinkelt
45° horizontal angled up

Gesamtlänge
Total length

TITAN
Küretten, halbscharf, TITAN
Curettes, semi-sharp, TITANIUM

06-51-046T	06-51-051T	280 mm / 11"	HARDY	ø 2 mm
06-51-047T	06-51-052T	280 mm / 11"	HARDY	ø 3 mm
06-51-048T	06-51-053T	280 mm / 11"	HARDY	ø 4 mm
06-51-049T	06-51-054T	280 mm / 11"	HARDY	ø 5 mm
06-51-050T	06-51-055T	280 mm / 11"	HARDY	ø 6 mm
06-01-041T	06-01-042T	280 mm / 11"	NICOLA	ø 6,5 mm

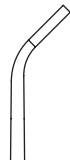

2/3
HARDY
06-01-045T
280 mm
11"

 45° rechts,
 langer Hals
 45° right,
 long neck

 45° rechts,
 kurzer Hals
 45° right,
 short neck

 45° links,
 langer Hals
 45° left,
 long neck

 45° links,
 kurzer Hals
 45° left,
 short neck

Küretten, scharf
Curettes, sharp

						Gesamtlänge Total length
ø 2 mm	HARDY	06-56-620	06-56-623	06-56-626	06-56-629	240 mm / 9½"
ø 3 mm	HARDY	06-56-612	06-56-618	06-56-614	06-56-607	240 mm / 9½"
ø 4 mm	HARDY	06-56-621	06-56-624	06-56-627	06-56-630	240 mm / 9½"
ø 5 mm	HARDY	06-56-613	06-56-619	06-56-615	06-56-608	240 mm / 9½"
ø 6 mm	HARDY	06-56-622	06-56-625	06-56-628	06-56-631	240 mm / 9½"

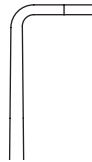
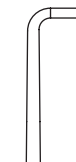
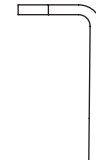
 90° rechts,
 langer Hals
 90° right,
 long neck

 90° rechts,
 kurzer Hals
 90° right,
 short neck

 90° links,
 langer Hals
 90° left,
 long neck

 90° links,
 kurzer Hals
 90° left,
 short neck

Küretten, scharf
Curettes, sharp

						Gesamtlänge Total length
ø 2 mm	HARDY	06-56-632	06-56-637	06-56-640	06-56-645	240 mm / 9½"
ø 3 mm	HARDY	06-56-633	06-56-605	06-56-641	06-56-616	240 mm / 9½"
ø 4 mm	HARDY	06-56-634	06-56-638	06-56-642	06-56-646	240 mm / 9½"
ø 5 mm	HARDY	06-56-635	06-56-606	06-56-643	06-56-617	240 mm / 9½"
ø 6 mm	HARDY	06-56-636	06-56-639	06-56-644	06-56-647	240 mm / 9½"



 45° vertikal aufwärts ge-
 winkelt, beidseitig arbeitend
 45° vertical angled up,
 working on both sides

 45° horizontal aufwärts
 gewinkelt
 45° horizontal angled up

Küretten, scharf
Curettes, sharp

				Gesamtlänge Total length
ø 2 mm	HARDY	06-56-648	06-56-653	240 mm / 9½"
ø 3 mm	HARDY	06-56-649	06-56-601	240 mm / 9½"
ø 4 mm	HARDY	06-56-650	06-56-654	240 mm / 9½"
ø 5 mm	HARDY	06-56-651	06-56-602	240 mm / 9½"
ø 6 mm	HARDY	06-56-652	06-56-655	240 mm / 9½"

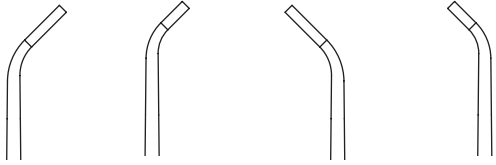
 2/3
 HARDY
 06-56-619
 240 mm
 9½"



45° rechts, langer Hals
45° right, long neck

45° rechts, kurzer Hals
45° right, short neck

45° links, langer Hals
45° left, long neck

45° links, kurzer Hals
45° left, short neck

Gesamtlänge
Total length

TITAN

Küretten, scharf, TITAN
Curettes, sharp, TITANIUM

06-56-620T	06-56-623T	06-56-626T	06-56-629T	240 mm / 9½"	HARDY	ø 2 mm
06-56-612T	06-56-618T	06-56-614T	06-56-607T	240 mm / 9½"	HARDY	ø 3 mm
06-56-621T	06-56-624T	06-56-627T	06-56-630T	240 mm / 9½"	HARDY	ø 4 mm
06-56-613T	06-56-619T	06-56-615T	06-56-608T	240 mm / 9½"	HARDY	ø 5 mm
06-56-622T	06-56-625T	06-56-628T	06-56-631T	240 mm / 9½"	HARDY	ø 6 mm

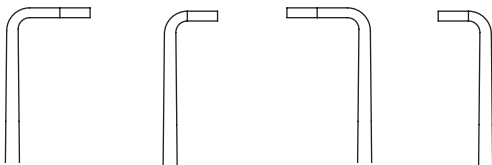

90° rechts, langer Hals
90° right, long neck

90° rechts, kurzer Hals
90° right, short neck

90° links, langer Hals
90° left, long neck

90° links, kurzer Hals
90° left, short neck

Gesamtlänge
Total length

TITAN

Küretten, scharf, TITAN
Curettes, sharp, TITANIUM

06-56-632T	06-56-637T	06-56-640T	06-56-645T	240 mm / 9½"	HARDY	ø 2 mm
06-56-633T	06-56-605T	06-56-641T	06-56-616T	240 mm / 9½"	HARDY	ø 3 mm
06-56-634T	06-56-638T	06-56-642T	06-56-646T	240 mm / 9½"	HARDY	ø 4 mm
06-56-635T	06-56-606T	06-56-643T	06-56-617T	240 mm / 9½"	HARDY	ø 5 mm
06-56-636T	06-56-639T	06-56-644T	06-56-647T	240 mm / 9½"	HARDY	ø 6 mm



45° vertikal aufwärts ge-
winkelt, beidseitig arbeitend
45° vertical angled up,
working on both sides

45° horizontal aufwärts
gewinkelt
45° horizontal angled up

Gesamtlänge
Total length

TITAN

Küretten, scharf, TITAN
Curettes, sharp, TITANIUM

06-56-648T	06-56-653T	240 mm / 9½"	HARDY	ø 2 mm
06-56-649T	06-56-601T	240 mm / 9½"	HARDY	ø 3 mm
06-56-650T	06-56-654T	240 mm / 9½"	HARDY	ø 4 mm
06-56-651T	06-56-602T	240 mm / 9½"	HARDY	ø 5 mm
06-56-652T	06-56-655T	240 mm / 9½"	HARDY	ø 6 mm





vertikal
aufwärts
gebogen,
rechts
schneidend,
biegsam
vertical
curved up,
right cutting,
malleable

vertikal
aufwärts ge-
bogen, links
schneidend,
biegsam
vertical
curved up,
left cutting,
malleable

horizontal
aufwärts
gewinkelt,
biegsam
horizontal
angled up,
malleable

Küretten
Curettes
Gesamtlänge
Total length

ø 6,5 mm	NICOLA	06-06-616			260 mm / 10¼"
ø 6,5 mm	NICOLA		06-06-617		260 mm / 10¼"
ø 6,5 mm	NICOLA			06-06-618	260 mm / 10¼"



6



vertikal
aufwärts
gebogen,
rechts
schneidend,
biegsam
vertical
curved up,
right cutting,
malleable

vertikal
aufwärts ge-
bogen, links
schneidend,
biegsam
vertical
curved up,
left cutting,
malleable

horizontal
aufwärts
gewinkelt,
biegsam
horizontal
angled up,
malleable

TITAN
Küretten, TITAN
Curettes, TITANIUM
Gesamtlänge
Total length

ø 6,5 mm	NICOLA	06-06-616T			260 mm / 10¼"
ø 6,5 mm	NICOLA		06-06-617T		260 mm / 10¼"
ø 6,5 mm	NICOLA			06-06-618T	260 mm / 10¼"

 2/3
 NICOLA
 06-06-616
 260 mm
 10¼"

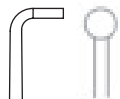

90° horizontal aufwärts
gewinkelt, biegsam
90° horizontal angled up,
malleable

06-06-631



90° horizontal aufwärts
gewinkelt, biegsam
90° horizontal angled up,
malleable

06-06-632

Gesamtlänge
Total length

260 mm / 10¼"

HARDY

Küretten
Curettes

ø 4 mm

260 mm / 10¼"

HARDY

ø 6 mm



90° horizontal aufwärts
gewinkelt, biegsam
90° horizontal angled up,
malleable

06-06-631T



90° horizontal aufwärts
gewinkelt, biegsam
90° horizontal angled up,
malleable

06-06-632T

Gesamtlänge
Total length

260 mm / 10¼"

HARDY

TITAN
Küretten, TITAN
Curettes, TITANIUM

ø 4 mm

260 mm / 10¼"

HARDY

ø 6 mm



6

2/3
HARDY
06-06-631
260 mm
10¼"



**Enukleator
abwärts
gebogen,
Klinge rechts**
*Enucleator
curved down,
blade right*



**Enukleator
abwärts
gebogen,
Klinge links**
*Enucleator
curved down,
blade left*



**Enukleator
aufwärts
gebogen,
Klinge rechts**
*Enucleator
curved up,
blade right*



**Enukleator
aufwärts
gebogen,
Klinge links,**
*Enucleator
curved up,
blade left*

Gesamtlänge
Total length

stumpf / blunt	HARDY	06-06-620	06-06-650	06-06-621	06-06-651	245 mm / 9¾"
scharf / sharp	HARDY	06-06-622	06-06-652	06-06-623	06-06-653	245 mm / 9¾"



**Dissektor
abwärts
gebogen,
Klinge links**
*Dissector
curved down,
blade left*



**Dissektor
aufwärts
gebogen,
Klinge rechts**
*Dissector
curved up,
blade right*



**Implanta-
tionsgabel**
Implant Fork



**Raspatorium
abwärts
gebogen**
*Raspatory
curved down*

Gesamtlänge
Total length

	HARDY- FAHLBUSCH	06-06-608	06-06-609			245 mm / 9¾"
	HARDY			06-06-624		245 mm / 9¾"
	NICOLA				06-06-619	215 mm / 8¼"



Mikro-Häkchen
 1,7 mm
Micro Hook
 1.7 mm



Dissektor stumpf
 2,0 mm
Dissector blunt
 2.0 mm

Gesamtlänge
Total length

	LANDOLT- REULEN	06-56-656	06-56-657			245 mm / 9¾"
--	----------------------------	-----------	-----------	--	--	--------------

2/3
HARDY
06-06-650
 245 mm
 9¾"

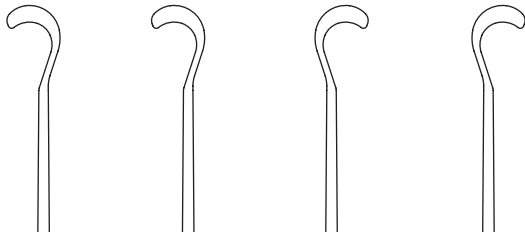

E nukleator abwärts gebogen, Klinge rechts
E nucleator curved down, blade right

E nukleator abwärts gebogen, Klinge links
E nucleator curved down, blade left

E nukleator aufwärts gebogen, Klinge rechts
E nucleator curved up, blade right

E nukleator aufwärts gebogen, Klinge links
E nucleator curved up, blade left

Gesamtlänge
Total length

TITAN

06-06-620T	06-06-650T	06-06-621T	06-06-651T	245 mm / 9¾"	HARDY	stumpf / <i>blunt</i>
06-06-622T	06-06-652T	06-06-623T	06-06-653T	245 mm / 9¾"	HARDY	scharf / <i>sharp</i>



Dissektor abwärts gebogen, Klinge links
Dissector curved down, blade left

Dissektor aufwärts gebogen, Klinge rechts
Dissector curved up, blade right

Raspatorium, abwärts gebogen
Raspatory, curved down

Gesamtlänge
Total length

TITAN

06-06-608T	06-06-609T			245 mm / 9¾"	HARDY-FAHLBUSCH	
		06-06-619T		215 mm / 8¾"		



Mikro-Häkchen 1,7 mm
Micro Hook 1.7 mm

Dissektor stumpf 2,0 mm
Dissector blunt 2.0 mm

Gesamtlänge
Total length

TITAN

06-56-656T	06-56-657T	245 mm / 9¾"	LANDOLT-REULEN	
------------	------------	--------------	-----------------------	--



2/3
HARDY
06-06-650
245 mm
9¾"



**Enukleator
abwärts
gebogen,
Klinge rechts,
biegsam**
*Enucleator
curved down,
blade right,
malleable*



**Enukleator
abwärts
gebogen,
Klinge links,
biegsam**
*Enucleator
curved down,
blade left,
malleable*



**Enukleator
aufwärts
gebogen,
Klinge rechts,
biegsam**
*Enucleator
curved up,
blade right
malleable*



**Enukleator
aufwärts
gebogen,
Klinge links,
biegsam**
*Enucleator
curved up,
blade left
malleable*

Gesamtlänge
Total length

stumpf / blunt	LANDOLT	06-06-625	06-06-655	06-06-626	06-06-656	260 mm / 10¼"
----------------	----------------	------------------	------------------	------------------	------------------	---------------

**Enukleator
abwärts
gebogen,
Klinge rechts,
biegsam**
*Enucleator
curved down,
blade right,
malleable*

**Enukleator
abwärts
gebogen,
Klinge links,
biegsam**
*Enucleator
curved down,
blade left,
malleable*

**Enukleator
aufwärts
gebogen,
Klinge rechts,
biegsam**
*Enucleator
curved up,
blade right
malleable*

**Enukleator
aufwärts
gebogen,
Klinge links,
biegsam**
*Enucleator
curved up,
blade left
malleable*

Gesamtlänge
Total length

stumpf / blunt	LANDOLT	06-06-625T	06-06-655T	06-06-626T	06-06-656T	260 mm / 10¼"
----------------	----------------	-------------------	-------------------	-------------------	-------------------	---------------

TITAN



**Löffel,
biegsam**
*Spoon,
malleble*



**Häkchen,
stumpf,
biegsam**
*Hook, blunt,
malleable*



**Gabelspatel,
fest**
*Fork spatula,
rigid*



**Kürette,
biegsam**
*Curette,
malleble*

Gesamtlänge
Total length

	LANDOLT	06-06-628				260 mm / 10¼"
	LANDOLT		06-06-629			260 mm / 10¼"
	HOSOBUCHI			06-06-630		260 mm / 10¼"
	LANDOLT				06-06-627	260 mm / 10¼"

TITAN

	LANDOLT		06-06-629T			260 mm / 10¼"
--	----------------	--	-------------------	--	--	---------------



2/3
LANDOLT
06-06-625
260 mm
10¼"



Löffel,
biegsam
Spoon,
malleable

Kürette,
biegsam
Curette,
malleable

Kürette, fest
Curette, rigid

Gesamtlänge
Total length

06-06-635				260 mm / 10¼"	FAHLBUSCH	ø 2,0 mm
	06-06-637			260 mm / 10¼"	FAHLBUSCH	ø 2,5 mm
		06-06-642		260 mm / 10¼"	LANDOLT-REULEN	ø 2,5 mm

Löffel,
biegsam
Spoon,
malleable

Kürette,
biegsam
Curette,
malleable

Kürette, fest
Curette, rigid

Gesamtlänge
Total length

TITAN

06-06-635T				260 mm / 10¼"	FAHLBUSCH	ø 2,0 mm
	06-06-637T			260 mm / 10¼"	FAHLBUSCH	ø 2,5 mm
		06-06-642T		260 mm / 10¼"	LANDOLT-REULEN	ø 2,5 mm



Raspatorium,
fest
Raspatory,
rigid

Raspatorium,
fest
Raspatory,
rigid

Häkchen,
stumpf, fest
Hook, blunt,
rigid

Dissektor,
fest
Dissector,
rigid

Gesamtlänge
Total length

06-06-640				260 mm / 10¼"	LANDOLT-REULEN	ø 2,2 mm
	06-06-641			260 mm / 10¼"	LANDOLT-REULEN	ø 3,2 mm
		06-06-643		260 mm / 10¼"	LANDOLT-REULEN	
			06-06-644	260 mm / 10¼"	LANDOLT-REULEN	

Raspatorium,
fest
Raspatory,
rigid

Raspatorium,
fest
Raspatory,
rigid

Häkchen,
stumpf, fest
Hook, blunt,
rigid

Dissektor,
fest
Dissector,
rigid

Gesamtlänge
Total length

TITAN

06-06-640T				260 mm / 10¼"	LANDOLT-REULEN	ø 2,2 mm
	06-06-641T			260 mm / 10¼"	LANDOLT-REULEN	ø 3,2 mm
		06-06-643T		260 mm / 10¼"	LANDOLT-REULEN	
			06-06-644T	260 mm / 10¼"	LANDOLT-REULEN	



2/3
FAHLBUSCH
06-06-635
260 mm
10¼"



Mikro-Neurochirurgische Instrumente
Micro-Neurosurgical Instruments

HF-Instrumente und Zubehör
HF Instruments and Accessoires

Kopf-Schädelinstrumente und Haltesysteme
Head-Cranio Instruments and Holding Systems

Aneurysmen-Clip System
Aneurysm Clip System

Schädel-Verplattung
Cranial Plate System

Hypophysektomie-Instrumente
Pituitary Instruments

Instrumente für die Wirbelsäule, Wundspreizer
Spine Instruments, Self-retaining Retractors



Laminektomie-Stanzen, Rongeurs, Hohlmeißelzangen
Laminectomy Punches, Rongeurs

Gefäß- und Bulldogklemmen, Gefäß-Clips
Vessel- and Bulldog-Clamps, Vessel Clips

Allgemeinchirurgische Instrumente
General Surgical Instruments

Alphabetischer Index, Numerischer Index
Alphabetical Index, Numerical Index

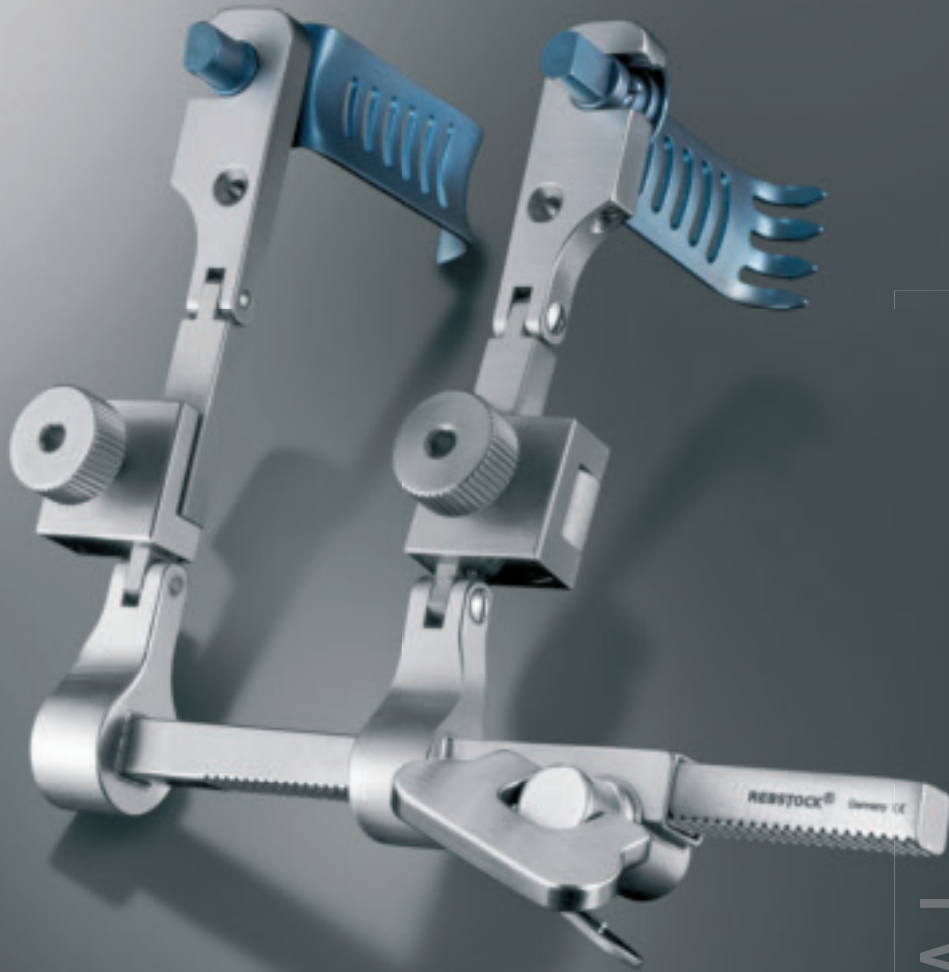

SURGICAL
INSTRUMENTS
MICRO-NEURO-SPINE

/// 07

REBSTOCK®
Precision made in Germany

/// Instrumente für die Wirbelsäule, Wundspreizer
Spine Instruments, Self-retaining Retractors

Artikel-Nr.
Cat. No.

	CASPAR	06-06-890	Wirbelkörper-Distraktor zur anterioren, zervikalen Verplattung, für rechtsseitigen Zugang zu C5-T1/2 und linksseitigem Zugang zur oberen HWS, komplett, bestehend aus: <i>Vertebral Body Distractor for anterior, cervical plating, for use in surgical procedures from the right approach for C5 through T1/2 and from the left approach for the upper cervical spine, complete, consisting of:</i>
			06-06-891 1x Distraktor, allein <i>distractor, only</i>
			06-06-897 1x Bohrlehre, rechts <i>drill guide, right</i>
			06-06-908 1x Bohrer <i>twist drill</i>
			06-06-905 1x Distraktionsschrauben, 16 mm <i>distraction screw, 16 mm</i> VE = 2 Stück <i>pack. à 2 pcs.</i>
			06-06-906 1x Schraubendreher <i>screwdriver</i>



Artikel-Nr.
 Cat. No.

06-06-900	<p>Wirbelkörper-Distraktor zur anterioren, zervikalen Verplattung, für linksseitigen Zugang zu C5-T1/2 und rechtsseitigem Zugang zur oberen HWS, komplett, bestehend aus: <i>Vertebral Body Distractor for anterior, cervical plating, for use in surgical procedures from the left approach for C5 through T1/2 and from the right approach for the upper cervical spine, complete, consisting of:</i></p>	CASPAR
06-06-901	1x Distraktor, allein <i>distractor, only</i>	
06-06-907	1x Bohrlehre, links <i>drill guide, left</i>	
06-06-908	1x Bohrer <i>twist drill</i>	
06-06-905	1x Distraktionsschrauben, 16 mm VE = 2 Stück <i>distraction screw, 16 mm pack. à 2 pcs.</i>	
06-06-906	1x Schraubendreher <i>screwdriver</i>	

Artikel-Nr.
Cat. No.

CASPAR

06-06-891

Wirbelkörper-Distraktor, alleine, für rechtsseitigen Zugang zu C5-T1/2 und linksseitigen Zugang zur oberen HWS, max. Spreizweite 70 mm

vertebral body distractor, only, for use in surgical procedures from the right approach for C5 through T1/2 and from the left approach for the upper cervical spine, max. spread 70 mm

CASPAR

06-06-893

Wirbelkörper-Distraktor, alleine, mit verlängerter Führungsstange für eine multisegmentale Distraction für rechtsseitigen Zugang zu C5-T1/2 und linksseitigen Zugang zur oberen HWS, max. Spreizweite 90 mm

vertebral body distractor, only, with elongated toothed bar, for multilevel distraction for use in surgical procedures from the right approach for C5 through T1/2 and from the left approach for the upper cervical spine, max. spread 90 mm

2/3
 CASPAR
 06-06-891

Artikel-Nr.
Cat. No.

CASPAR

06-06-897

Bohrlehre, rechts
 für Distraktor 06-06-891 und 06-06-893

*drill guide, right
 for distractor 06-06-891 and 06-06-893*

2/3
 CASPAR
 06-06-897

Artikel-Nr.
Cat. No.

<p>06-06-901</p>	<p>Wirbelkörper-Distraktor, alleine, für linksseitigen Zugang zu C5-T1/2 und rechtsseitigen Zugang zur oberen HWS, max. Spreizweite 70 mm</p> <p><i>vertebral body distractor, only, for use in surgical procedures from the left approach for C5 through T1/2 and from the right approach for the upper cervical spine, max. spread 70 mm</i></p>	<p>CASPAR</p>	
<p>06-06-903</p>	<p>Wirbelkörper-Distraktor, alleine, mit verlängerter Führungsstange für eine multisegmentale Distraction für linksseitigen Zugang zu C5-T1/2 und rechtsseitigen Zugang zur oberen HWS, max. Spreizweite 90 mm</p> <p><i>vertebral body distractor, only, with elongated toothed bar, for multilevel distraction for use in surgical procedures from the left approach for C5 through T1/2 and from the right approach for the upper cervical spine, max. spread 90 mm</i></p>	<p>CASPAR</p>	

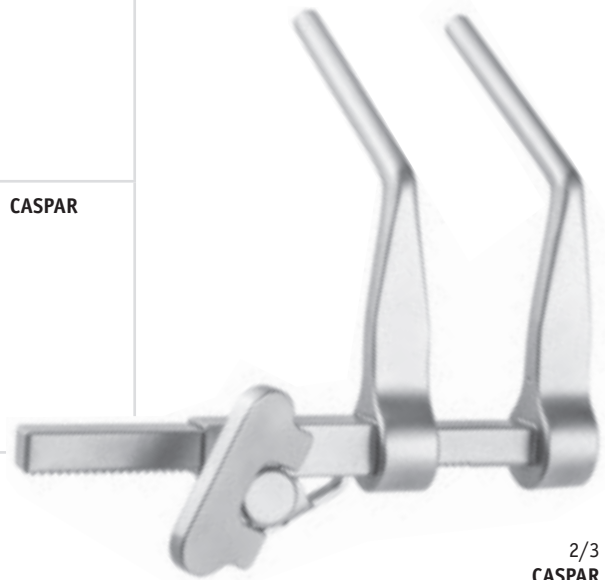

2/3
CASPAR
06-06-901



2/3
CASPAR
06-06-907

Artikel-Nr.
Cat. No.

<p>06-06-907</p>	<p>Bohrlehre, links für Distraktor 06-06-901 und 06-06-903</p> <p><i>drill guide, left for distractor 06-06-901 and 06-06-903</i></p>	<p>CASPAR</p>	
-------------------------	---	---------------	--



1/2
CASPAR
06-06-905
 16 mm

Artikel-Nr.
Cat. No.

Gewindelänge
length of thread

	CASPAR	Artikel-Nr. Cat. No.	Gewindelänge length of thread
		06-06-912	12 mm
		06-06-904	14 mm
		06-06-905	16 mm
		06-06-909	18 mm
			Distraktionsschrauben, zur Verwendung mit den Distraktoren 06-06-891, 06-06-893, 06-06-901 und 06-06-903 (VE = 2 Stück)
			<i>distraction screws, to be used with distractors 06-06-891, 06-06-893, 06-06-901 and 06-06-903 (pack. à 2 pcs.)</i>



1/2
CASPAR
06-06-908
 145 mm
 5 3/4"

Artikel-Nr.
Cat. No.

Gesamtlänge
Total length

	CASPAR	Artikel-Nr. Cat. No.	Gesamtlänge Total length
		06-06-908	145 mm / 5 3/4"
			Bohrer ø 1,7 mm für Distraktionsschrauben, Bohrtiefe 8 mm
			<i>twist drill ø 1,7 mm for distractions screws, drilling depth 8 mm</i>





1/2
CASPAR
06-06-906
 200 mm
 8"

Artikel-Nr.
Cat. No.

Gesamtlänge
Total length

	CASPAR	Artikel-Nr. Cat. No.	Gesamtlänge Total length
		06-06-906	200 mm / 8"
			Schraubendreher für Distraktionsschrauben <i>screwdriver for distraction screws</i>

Artikel-Nr. Cat. No.	Gesamtlänge Total length		
06-06-917	205 mm / 8"	CASPAR	1/1 
06-06-918	205 mm / 8"	CASPAR	1/1 



1/2
CASPAR
06-06-917
205 mm
8"

Artikel-Nr. Cat. No.			
01-01-845	Messschieber zum Vermessen des Knochenspans und des Span-Situs Messbereich 0-125 mm <i>caliper, for measurement of the bone graft and graft site measuring range 0-125 mm</i>	CASPAR	



CASPAR
01-01-845

Artikel-Nr. Cat. No.	Gesamtlänge Total length		
06-06-911	220 mm / 8 1/4"	CASPAR	

Knochenspanhalter und
-einsetzinstrument
bone graft holder and impactor



1/2
CASPAR
06-06-911
220 mm
8 1/4"





1/2
CASPAR
06-11-775
 220 mm
 8¾"

		Artikel-Nr. Cat. No.	Gesamtlänge Total length
1/1 3,6 mm		CASPAR 06-11-773	220 mm / 8¾" gerade straight
1/1 4,4 mm		CASPAR 06-11-774	220 mm / 8¾" gerade straight
1/1 5,2 mm		CASPAR 06-11-775	220 mm / 8¾" gerade straight
1/1 3,6 mm		CASPAR 06-11-783	220 mm / 8¾" gebogen curved
1/1 4,4 mm		CASPAR 06-11-784	220 mm / 8¾" gebogen curved
1/1 5,2 mm		CASPAR 06-11-785	220 mm / 8¾" gebogen curved





1/2
CASPAR
06-11-835
 220 mm
 8¾"

		Artikel-Nr. Cat. No.	Gesamtlänge Total length
1/1 4 mm		CASPAR 06-11-834	220 mm / 8¾" gezahnt toothed
1/1 5 mm		CASPAR 06-11-835	220 mm / 8¾" gezahnt toothed
1/1 6 mm		CASPAR 06-11-836	220 mm / 8¾" gezahnt toothed

Artikel-Nr. Cat. No.	Gesamtlänge Total length		
06-11-854	250 mm / 10"	CASPAR	1/1 4 mm 
06-11-855	250 mm / 10"	CASPAR	1/1 5 mm 

1/2
CASPAR
06-11-854
250 mm
10"









Artikel-Nr. Cat. No.	Gesamtlänge Total length		
06-11-863	270 mm / 10¾"	CASPAR	1/1 3 mm 
06-11-864	270 mm / 10¾"	CASPAR	1/1 4 mm 

1/2
CASPAR
06-11-863
270 mm
10¾"









1/2
CASPAR
06-06-913
 200 mm
 8"

			Artikel-Nr. Cat. No.	Gesamtlänge Total length
	1/1 3 mm	CASPAR	06-06-913	200 mm / 8"
	1/1 5 mm	CASPAR	06-06-914	200 mm / 8"
	1/1 8 mm	CASPAR	06-06-915	200 mm / 8"
	1/1 12 mm		06-12-090	200 mm / 8"
	1/1 14 mm		06-12-091	200 mm / 8"
	1/1 16 mm		06-12-092	200 mm / 8"



1/3
SYPERT
06-07-093
 290 mm
 11½"

			Artikel-Nr. Cat. No.	Gesamtlänge Total length
	1/1 3 x 8 mm	SYPERT	06-07-093	290 mm / 11½"
	1/1 4 x 10 mm	SYPERT	06-07-094	290 mm / 11½"
	1/1 5 x 15 mm	SYPERT	06-07-095	290 mm / 11½"
	1/1 6 x 20 mm	SYPERT	06-07-096	290 mm / 11½"

Die K-Line Küretten sind speziell für den Einsatz in der Mikrodiskektomie geeignet. Sie sind in drei Ausführungen erhältlich und entsprechen den speziellen klinischen Anforderungen der Wirbelsäulenchirurgie.

Zervikale Küretten

Kleine Löffelgrößen, für die kleine Anatomie im zervikalen Bereich.

Zervikale lange Küretten

Gleiche Spitzenkonfiguration wie die zervikalen Küretten, jedoch länger, für eine größere Reichweite.

Lumbale Küretten

Größere Löffel, optimal für lumbale Eingriffe.

- Bajonett-Ausführung für verbesserte Visualisierung
- Ergonomischer Handgriff für optimale Kontrolle
- Große Anzahl an Konfigurationen und Größen

K-Line curettes are specifically suitable for the use in microdiscectomy procedures. They are available in three designs to meet the unique clinical needs of spinal surgery.

Cervical Curettes

Smaller cup sizes for the smaller anatomy in the cervical area.

Cervical Long Curettes

Same tip configurations as the cervical curettes, but longer to improve reach.

Lumbar Curettes

Larger cup sizes optimally suited for lumbar procedures.

- bayonet design for improved visualization
- ergonomic handle for enhanced control
- multiple tip configurations and sizes



Ausführungen
Tip configurations

BS abwärts gerade <i>backward straight</i>	
BA abwärts gewinkelt <i>backward angle</i>	
BD abwärts schneidend / aufwärts gewinkelt <i>backward down</i>	
FS aufwärts gerade <i>forward straight</i>	
FA aufwärts gewinkelt <i>forward angle</i>	
FD aufwärts schneidend / abwärts gewinkelt <i>forward down</i>	



	Größe <i>Size</i>	Figur <i>Figure</i>
	4.0 mm	2
	3.5 mm	1
	3.0 mm	0
	2.7 mm	00
	2.4 mm	000
	1.6 mm	0000







Artikel-Nr.
Cat. No.

13-56-200

K-LINE Zervikal Mikrodiskektomie Instrumenten Set, bestehend aus:
K-LINE Cervical Microdiscectomy Instrument Set, consisting of:

13-06-251	1 x Kürette, 3,0 mm, FS <i>curette, 3.0 mm, FS</i>	13-06-264	1 x Kürette, 1,6 mm, BS <i>curette, 1.6 mm, BS</i>
13-06-252	1 x Kürette, 2,7 mm, FS <i>curette, 2.7 mm, FS</i>	13-06-265	1 x Kortikal Kürette, 3,0 mm, BS <i>cortical bone cutter, 3.0 mm, BS</i>
13-06-253	1 x Kürette, 2,4 mm, FS <i>curette, 2.4 mm, FS</i>	13-06-266	1 x Kürette, 3,0 mm, BA <i>curette, 3.0 mm, BA</i>
13-06-254	1 x Kürette, 1,6 mm, FS <i>curette, 1.6 mm, FS</i>	13-06-267	1 x Kürette, 2,7 mm, BA <i>curette, 2.7 mm, BA</i>
13-06-255	1 x Kortikal Kürette, 3,0 mm, FS <i>cortical bone cutter, 3.0 mm, FS</i>	13-06-268	1 x Kürette, 2,4 mm, BA <i>curette, 2.4 mm, BA</i>
13-06-256	1 x Kürette, 3,0 mm, FA <i>curette, 3.0 mm, FA</i>	13-06-269	1 x Kürette, 1,6 mm, BA <i>curette, 1.6 mm, BA</i>
13-06-257	1 x Kürette, 2,7 mm, FA <i>curette, 2.7 mm, FA</i>	13-06-270	1 x Kortikal Kürette, 3,0 mm, BA <i>cortical bone cutter, 3.0 mm, BA</i>
13-06-258	1 x Kürette, 2,4 mm, FA <i>curette, 2.4 mm, FA</i>	13-06-321	1 x Zervikal Mikro Nerv Haken <i>cervical micro nerve hook</i>
13-06-259	1 x Kürette, 1,6 mm, FA <i>curette, 1.6 mm, FA</i>	13-06-322	1 x Zervikal Mikro Nerv Haken, extra fein <i>cervical ultra micro nerve hook</i>
13-06-260	1 x Kortikal Kürette, 3,0 mm, FA <i>cortical bone cutter, 3.0 mm, FA</i>	13-06-323	1 x Zervikal Knochenwaxser <i>cervical bone waxer</i>
13-06-261	1 x Kürette, 3,0 mm, BS <i>curette, 3.0 mm, BS</i>	10-56-032	2 x Sterilisationscontainer mit Siebeinsatz für 12 Küretten, 380 x 260 x 65 mm <i>sterilisation case with tray insert for 12 currettes, 380 x 260 x 65 mm</i>
13-06-262	1 x Kürette, 2,7 mm, BS <i>curette, 2.7 mm, BS</i>		
13-06-263	1 x Kürette, 2,4 mm, BS <i>curette, 2.4 mm, BS</i>		

Zervikale Kürette mit Bajonettgriff
Cervical Curette with bayonet handle

Artikel-Nr. Cat. No.	Gesamtlänge Total length	Konfiguration Configuration	Figur Figure	Größe Size
13-06-254	215 mm / 8½"	FS	0000	1,6 mm
13-06-253	215 mm / 8½"	FS	000	2,4 mm
13-06-252	215 mm / 8½"	FS	00	2,7 mm 
13-06-251	215 mm / 8½"	FS	0	3,0 mm
13-06-255	215 mm / 8½"	FS		3,0 mm Kortal Kürette cortical bone cutter
13-06-259	215 mm / 8½"	FA	0000	1,6 mm
13-06-258	215 mm / 8½"	FA	000	2,4 mm
13-06-257	215 mm / 8½"	FA	00	2,7 mm 
13-06-256	215 mm / 8½"	FA	0	3,0 mm
13-06-260	215 mm / 8½"	FA		3,0 mm Kortal Kürette cortical bone cutter
13-06-264	215 mm / 8½"	BS	0000	1,6 mm
13-06-263	215 mm / 8½"	BS	000	2,4 mm
13-06-262	215 mm / 8½"	BS	00	2,7 mm 
13-06-261	215 mm / 8½"	BS	0	3,0 mm
13-06-265	215 mm / 8½"	BS		3,0 mm Kortal Kürette cortical bone cutter
13-06-269	215 mm / 8½"	BA	0000	1,6 mm
13-06-268	215 mm / 8½"	BA	000	2,4 mm
13-06-267	215 mm / 8½"	BA	00	2,7 mm 
13-06-266	215 mm / 8½"	BA	0	3,0 mm
13-06-270	215 mm / 8½"	BA		3,0 mm Kortal Kürette cortical bone cutter



2/3
13-06-253
215 mm
8½"

Artikel-Nr. Cat. No.	Gesamtlänge Total length		
13-06-321	215 mm / 8½"	Zervikal Mikro Nerv Haken cervical micro nerve hook	
13-06-322	215 mm / 8½"	Zervikal Mikro Nerv Haken, extra fein cervical ultra micro nerve hook	
13-06-323	215 mm / 8½"	Zervikal Knochenwachser cervical bone waxer	





Artikel-Nr.
Cat. No.

13-56-201

K-LINE Zervikal Mikrodiskektomie Instrumenten Set, lang, bestehend aus:
K-LINE Cervical Microdiscectomy Instrument Set, long, consisting of:

13-06-272	1 x Kürette, 3,0 mm, FS <i>curette, 3.0 mm, FS</i>	13-06-285	1 x Kürette, 1,6 mm, BS <i>curette, 1.6 mm, BS</i>
13-06-273	1 x Kürette, 2,7 mm, FS <i>curette, 2.7 mm, FS</i>	13-06-286	1 x Kortikal Kürette, 3,0 mm, BS <i>cortical bone cutter, 3.0 mm, BS</i>
13-06-274	1 x Kürette, 2,4 mm, FS <i>curette, 2.4 mm, FS</i>	13-06-287	1 x Kürette, 3,0 mm, BA <i>curette, 3.0 mm, BA</i>
13-06-275	1 x Kürette, 1,6 mm, FS <i>curette, 1.6 mm, FS</i>	13-06-288	1 x Kürette, 2,7 mm, BA <i>curette, 2.7 mm, BA</i>
13-06-276	1 x Kortikal Kürette, 3,0 mm, FS <i>cortical bone cutter, 3.0 mm, FS</i>	13-06-289	1 x Kürette, 2,4 mm, BA <i>curette, 2.4 mm, BA</i>
13-06-277	1 x Kürette, 3,0 mm, FA <i>curette, 3.0 mm, FA</i>	13-06-290	1 x Kürette, 1,6 mm, BA <i>curette, 1.6 mm, BA</i>
13-06-278	1 x Kürette, 2,7 mm, FA <i>curette, 2.7 mm, FA</i>	13-06-291	1 x Kortikal Kürette, 3,0 mm, BA <i>cortical bone cutter, 3.0 mm, BA</i>
13-06-279	1 x Kürette, 2,4 mm, FA <i>curette, 2.4 mm, FA</i>	13-06-292	1 x Zervikal Mikro Nerv Haken <i>cervical micro nerve hook</i>
13-06-280	1 x Kürette, 1,6 mm, FA <i>curette, 1.6 mm, FA</i>	13-06-293	1 x Zervikal Mikro Nerv Haken, extra fein <i>cervical ultra micro nerve hook</i>
13-06-281	1 x Kortikal Kürette, 3,0 mm, FA <i>cortical bone cutter, 3.0 mm, FA</i>	13-06-294	1 x Zervikal Knochenwaxser <i>cervical bone waxer</i>
13-06-282	1 x Kürette, 3,0 mm, BS <i>curette, 3.0 mm, BS</i>	10-56-032	2 x Sterilisationscontainer mit Siebeinsatz für 12 Küretten, 380 x 260 x 65 mm <i>sterilisation case with tray insert for 12 currettes, 380 x 260 x 65 mm</i>
13-06-283	1 x Kürette, 2,7 mm, BS <i>curette, 2.7 mm, BS</i>		
13-06-284	1 x Kürette, 2,4 mm, BS <i>curette, 2.4 mm, BS</i>		

Lange zervikale Kürette mit Bajonettgriff
Long Cervical Curette with bayonet handle

Artikel-Nr. Cat. No.	Gesamtlänge Total length	Konfiguration Configuration	Figur Figure	Größe Size	
13-06-275	240 mm / 9½"	FS	0000	1,6 mm	
13-06-274	240 mm / 9½"	FS	000	2,4 mm	
13-06-273	240 mm / 9½"	FS	00	2,7 mm	
13-06-272	240 mm / 9½"	FS	0	3,0 mm	
13-06-276	240 mm / 9½"	FS		3,0 mm	Kortical Kürette <i>cortical bone cutter</i>
13-06-280	240 mm / 9½"	FA	0000	1,6 mm	
13-06-279	240 mm / 9½"	FA	000	2,4 mm	
13-06-278	240 mm / 9½"	FA	00	2,7 mm	
13-06-277	240 mm / 9½"	FA	0	3,0 mm	
13-06-281	240 mm / 9½"	FA		3,0 mm	Kortical Kürette <i>cortical bone cutter</i>
13-06-285	240 mm / 9½"	BS	0000	1,6 mm	
13-06-284	240 mm / 9½"	BS	000	2,4 mm	
13-06-283	240 mm / 9½"	BS	00	2,7 mm	
13-06-282	240 mm / 9½"	BS	0	3,0 mm	
13-06-286	240 mm / 9½"	BS		3,0 mm	Kortical Kürette <i>cortical bone cutter</i>
13-06-290	240 mm / 9½"	BA	0000	1,6 mm	
13-06-289	240 mm / 9½"	BA	000	2,4 mm	
13-06-288	240 mm / 9½"	BA	00	2,7 mm	
13-06-287	240 mm / 9½"	BA	0	3,0 mm	
13-06-291	240 mm / 9½"	BA		3,0 mm	Kortical Kürette <i>cortical bone cutter</i>



2/3
13-06-273
240 mm
9½"

Artikel-Nr. Cat. No.	Gesamtlänge Total length		
13-06-292	240 mm / 9½"	Zervikal Mikro Nerv Haken <i>cervical micro nerve hook</i>	
13-06-293	240 mm / 9½"	Zervikal Mikro Nerv Haken, extra fein <i>cervical ultra micro nerve hook</i>	
13-06-294	240 mm / 9½"	Zervikal Knochenwachser <i>cervical bone waxer</i>	





Artikel-Nr.
Cat. No.

13-56-202	K-LINE Lumbal Mikrodiskektomie Instrumenten Set, lang, bestehend aus: <i>K-LINE Lumbar Microdiscectomy Instrument Set, long, consisting of:</i>	
13-06-296	1 x	Kürette, 3,0 mm, FS <i>curette, 3.0 mm, FS</i>
13-06-297	1 x	Kürette, 3,5 mm, FS <i>curette, 3.5 mm, FS</i>
13-06-298	1 x	Kürette, 4,0 mm, FS <i>curette, 4.0 mm, FS</i>
13-06-299	1 x	Kürette, 3,0 mm, FA <i>curette, 3.0 mm, FA</i>
13-06-300	1 x	Kürette, 3,5 mm, FA <i>curette, 3.5 mm, FA</i>
13-06-301	1 x	Kürette, 4,0 mm, FA <i>curette, 4.0 mm, FA</i>
13-06-302	1 x	Kürette, 3,0 mm, FD <i>curette, 3.0 mm, FD</i>
13-06-303	1 x	Kürette, 3,5 mm, FD <i>curette, 3.5 mm, FD</i>
13-06-304	1 x	Kürette, 4,0 mm, FD <i>curette, 4.0 mm, FD</i>
13-06-305	1 x	Kürette, 3,0 mm, BS <i>curette, 3.0 mm, BS</i>
13-06-306	1 x	Kürette, 3,5 mm, BS <i>curette, 3.5 mm, BS</i>
13-06-307	1 x	Kürette, 4,0 mm, BS <i>curette, 4.0 mm, BS</i>
13-06-308	1 x	Kürette, 3,0 mm, BA <i>curette, 3.0 mm, BA</i>
13-06-309	1 x	Kürette, 3,5 mm, BA <i>curette, 3.5 mm, BA</i>
13-06-310	1 x	Kürette, 4,0 mm, BA <i>curette, 4.0 mm, BA</i>
13-06-311	1 x	Kürette, 3,0 mm, BD <i>curette, 3.0 mm, BD</i>
13-06-312	1 x	Kürette, 2,7 mm, BD <i>curette, 2.7 mm, BD</i>
13-06-313	1 x	Kürette, 2,4 mm, BD <i>curette, 2.4 mm, BD</i>
13-06-314	1 x	Lumbal PENFIELD Dissektor #1 <i>lumbar PENFIELD dissector #1</i>
13-06-315	1 x	Lumbal PENFIELD Dissektor #2 <i>lumbar PENFIELD dissector #2</i>
13-06-316	1 x	Lumbal Nerv Haken <i>lumbar nerve hook</i>
13-06-317	1 x	Lumbal PENFIELD Dissektor #4 <i>lumbar PENFIELD dissector #4</i>
13-06-318	1 x	Lumbal Knochenwaxer <i>lumbar bone waxer</i>
13-06-319	1 x	Lumbal Wirbelsäulensonde <i>lumbar spine probe</i>
10-56-032	2 x	Sterilisationscontainer mit Siebeinsatz für 12 Küretten, 380 x 260 x 65 mm <i>sterilisation case with tray insert for 12 curettes, 380 x 260 x 65 mm</i>

Lumbale Kürette mit Bajonettgriff
Lumbar Curette with bayonet handle

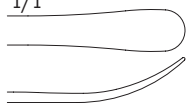
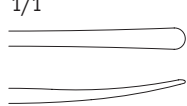
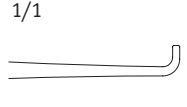
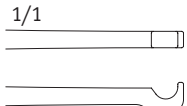
Artikel-Nr. Cat. No.	Gesamtlänge Total length	Konfiguration Configuration	Figur Figure	Größe Size
13-06-296	240 mm / 9½"	FS	0	3,0 mm
13-06-297	240 mm / 9½"	FS	1	3,5 mm
13-06-298	240 mm / 9½"	FS	2	4,0 mm
13-06-299	240 mm / 9½"	FA	0	3,0 mm
13-06-300	240 mm / 9½"	FA	1	3,5 mm
13-06-301	240 mm / 9½"	FA	2	4,0 mm
13-06-302	240 mm / 9½"	FD	0	3,0 mm
13-06-303	240 mm / 9½"	FD	1	3,5 mm
13-06-304	240 mm / 9½"	FD	2	4,0 mm
13-06-305	240 mm / 9½"	BS	0	3,0 mm
13-06-306	240 mm / 9½"	BS	1	3,5 mm
13-06-307	240 mm / 9½"	BS	2	4,0 mm
13-06-308	240 mm / 9½"	BA	0	3,0 mm
13-06-309	240 mm / 9½"	BA	1	3,5 mm
13-06-310	240 mm / 9½"	BA	2	4,0 mm
13-06-311	240 mm / 9½"	BD	0	3,0 mm
13-06-312	240 mm / 9½"	BD	1	3,5 mm
13-06-313	240 mm / 9½"	BD	2	4,0 mm

Artikel-Nr. Cat. No.	Gesamtlänge Total length		
13-06-314	240 mm / 9½"	PENFIELD	1/1 
13-06-315	240 mm / 9½"	PENFIELD	1/1 
13-06-317	240 mm / 9½"	PENFIELD	1/1 
13-06-316	240 mm / 9½"		1/1 
13-06-318	240 mm / 9½"		1/1 
13-06-319	240 mm / 9½"		1/1 



2/3
13-06-296
240 mm
9½"



Artikel-Nr.
Cat. No.

13-56-203	K-LINE Mikrodiskektomie Instrumenten Set, bestehend aus: <i>K-LINE Microdiscectomy Instrument Set, consisting of:</i>	
13-56-500	1x	Mikro-Kürette #1, vorwärts gebogen <i>micro curette #1, forward angled</i>
13-56-501	1x	Mikro-Kürette #1, rückwärts gebogen <i>micro curette #1, backward angled</i>
13-56-502	1x	Mikro-Kürette #2, vorwärts gebogen <i>micro curette #2, forward angled</i>
13-56-503	1x	Mikro-Kürette #2, rückwärts gebogen <i>micro curette #2, backward angled</i>
13-56-504	1x	Mikro-Kürette #3, vorwärts gebogen <i>micro curette #3, forward angled</i>
13-56-505	1x	Mikro-Kürette #3, rückwärts gebogen <i>micro curette #3, backward angled</i>
13-56-506	1x	Mikro-Kürette #4, vorwärts gebogen <i>micro curette #4, forward angled</i>
13-56-507	1x	Mikro-Kürette #4, rückwärts gebogen <i>micro curette #4, backward angled</i>
13-56-508	1x	Mikro-Kürette #5, vorwärts gebogen <i>micro curette #5, forward angled</i>
13-56-509	1x	Mikro-Kürette #5, rückwärts gebogen <i>micro curette #5, backward angled</i>
13-56-510	1x	Mikro-Dissektor, gerade, 3 mm <i>micro dissector, straight, 3 mm</i>
13-56-511	1x	Mikro-Dissektor, gerade, 5 mm <i>micro dissector, straight, 5 mm</i>
10-56-032	1x	Sterilisationscontainer mit Siebeinsatz für 12 Küretten, 380 x 260 x 65 mm <i>sterilisation case with tray insert for 12 curettes, 380 x 260 x 65 mm</i>



Mikro-Küretten und -Dissektoren mit rundem Bajonettgriff
Micro Curette and Dissector with round bayonet handle

Artikel-Nr. Cat. No.	Gesamtlänge Total length	Konfiguration Configuration	Figur Figure	Größe Size
13-56-500	259 mm / 10"	F	1	1,0 mm
13-56-501	259 mm / 10"	B	1	1,0 mm
13-56-502	259 mm / 10"	F	2	1,5 mm
13-56-503	259 mm / 10"	B	2	1,5 mm
13-56-504	259 mm / 10"	F	3	2,0 mm
13-56-505	259 mm / 10"	B	3	2,0 mm
13-56-506	259 mm / 10"	F	4	2,5 mm
13-56-507	259 mm / 10"	B	4	2,5 mm
13-56-508	259 mm / 10"	F	5	3,0 mm
13-56-509	259 mm / 10"	B	5	3,0 mm
13-56-510	259 mm / 10" Mikro-Dissektor micro dissector	gerade straight		3 mm
13-56-511	259 mm / 10" Mikro-Dissektor micro dissector	gerade straight		5 mm



2/3
13-56-500
 259 mm
 10"







13-56-325

Artikel-Nr.
Cat. No.

	13-56-325	Griff für Mikro-Messer <i>handle for micro knife</i>
--	------------------	---

Artikel-Nr.
Cat. No.

	13-56-327	Mikro-Messer, 2 mm <i>micro knife blade, 2 mm</i>
	13-56-328	Mikro-Messer, 1,5 mm <i>micro knife blade, 1.5 mm</i>



CCR-Doppelgelenk-Retraktor mit erweiterter Tiefenspreizung

- Doppelgelenke für flexible operative Anpassung
- Erweiterte Tiefenspreizung durch distal verstellbare Valven
- Side-load Aufnahme für einfachen und schnellen intra-operativen Valvenwechsel
- Umlegbare Flügelschraube
- Umfangreiche Auswahl an Valvengrößen und -ausführungen für individuelle und flexible Anwendung
- Gefensterte Titanvalven, semi-transparent, zum rutschsicheren und schonenden Sitz

CCR-Double Hinge Retractor with extended deep spreading

- double articulation for a flexible operative adjustment
- extended deep spreading by means of distally adjustable blades
- side-load attachment for an easy and quick intra-operative exchange of blades
- reversible wing screw
- a large selection of blade sizes and -designs for an individual and flexible application
- fenestrated titanium blades, semi-transparent, for a slip-resistant and gentle fit



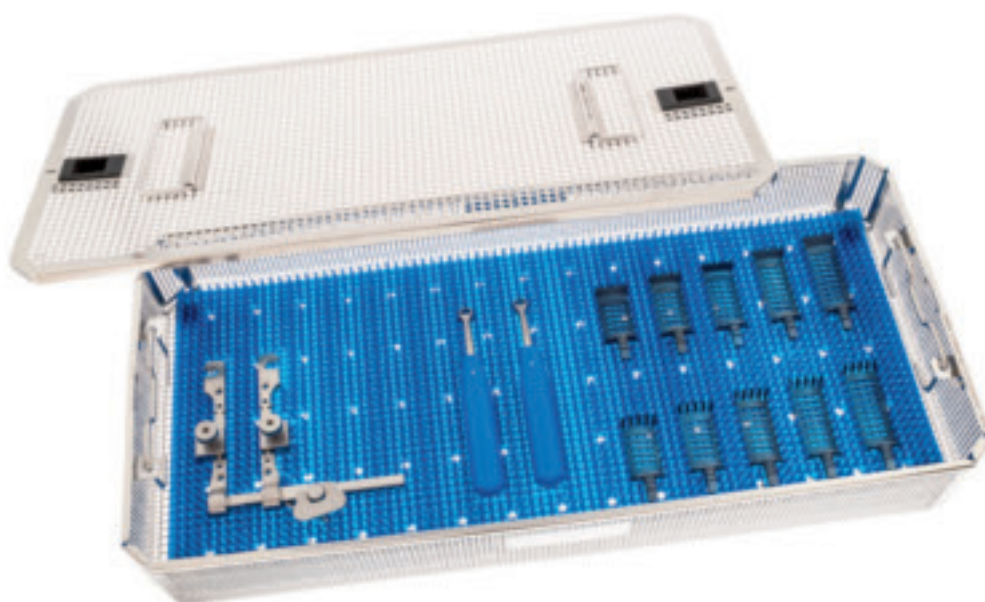

Artikel-Nr.
Cat. No.

02-73-122	CCR Zervikales Retraktor Set mit erweiterter Tiefenspreizung, bestehend aus: CCR Cervical Retractor Set with extended deep spreading, consisting of:	
10-07-224	1x	Siebkorb 545 x 255 x 100 mm aus Edelstahl <i>basket 545 x 255 x 100 mm, stainless steel screen</i>
10-06-227	1x	Deckel zu Siebkorb 545 x 255 mm aus Edelstahl, mit Verschluss <i>lid for basket 545 x 255 mm, with closure, stainless steel screen</i>
10-56-933	1x	Silikon-Matte 500 x 230 mm, blau <i>silicon mat 500 x 230 mm, blue</i>
02-73-049	1x	CCR Basis Retraktor, Doppelgelenk, mit erweiterter Tiefenspreizung <i>CCR basic retractor, double hinge, with extended deep spreading</i>
02-23-010	2x	Handgriff zum Einsetzen der Valven <i>handle for the insertion of blades</i>
02-23-143T	1x	CCR Valve, lateral 24 x 40 mm <i>CCR blade, lateral 24 x 40 mm</i>
02-23-144T	1x	CCR Valve, lateral 24 x 45 mm <i>CCR blade, lateral 24 x 45 mm</i>
02-23-145T	1x	CCR Valve, lateral 24 x 50 mm <i>CCR blade, lateral 24 x 50 mm</i>
02-23-146T	1x	CCR Valve, lateral 24 x 55 mm <i>CCR blade, lateral 24 x 55 mm</i>
02-23-147T	1x	CCR Valve, lateral 24 x 60 mm <i>CCR blade, lateral 24 x 60 mm</i>
02-23-153T	1x	CCR Valve, medial 24 x 40 mm <i>CCR blade, medial 24 x 40 mm</i>
02-23-154T	1x	CCR Valve, medial 24 x 45 mm <i>CCR blade, medial 24 x 45 mm</i>
02-23-155T	1x	CCR Valve, medial 24 x 50 mm <i>CCR blade, medial 24 x 50 mm</i>
02-23-156T	1x	CCR Valve, medial 24 x 55 mm <i>CCR blade, medial 24 x 55 mm</i>
02-23-157T	1x	CCR Valve, medial 24 x 60 mm <i>CCR blade, medial 24 x 60 mm</i>





Artikel-Nr.
Cat. No.

02-73-049	CCR Basisretractor, Doppelgelenk, mit erweiterter Tiefenspreizung <i>CCR basic retractor, double hinge, with extended deep spreading</i> (ohne Valven / <i>without blades</i>)	CASPAR modif.	
------------------	--	--------------------------	--

Passende Valven siehe Seite 286-289
suitable blades please see page 286-289



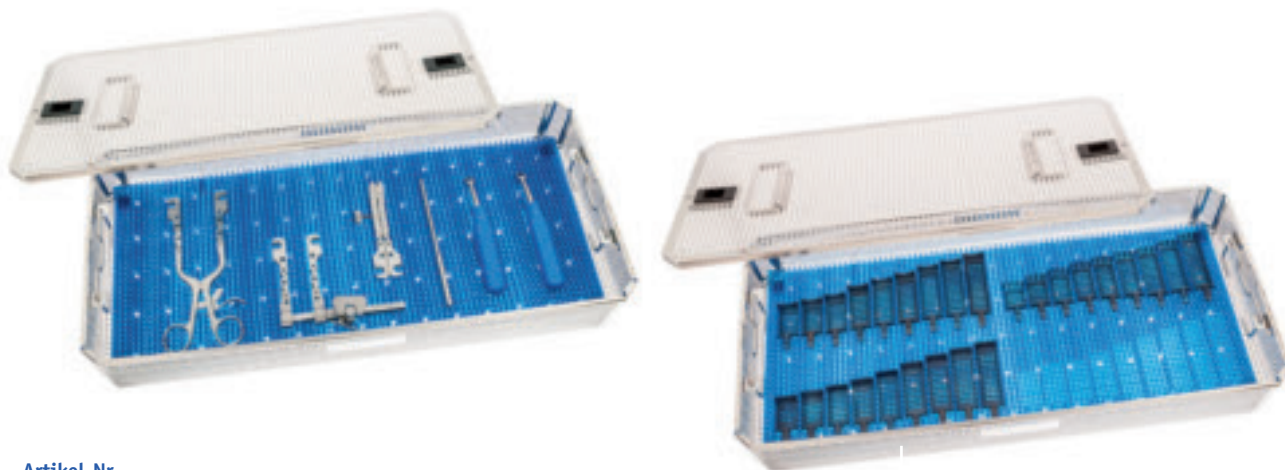

Artikel-Nr.
Cat. No.

02-23-124	CCR Zervikales Retraktor Set, bestehend aus: CCR Cervical Retractor Set, consisting of:	
10-07-224	2x	Siebkorb 545 x 255 x 100 mm aus Edelstahl <i>basket 545 x 255 x 100 mm, stainless steel screen</i>
10-06-227	2x	Deckel zu Siebkorb 545 x 255 mm aus Edelstahl, mit Verschluss <i>lid for basket 545 x 255 mm with closure, stainless steel screen</i>
10-56-933	2x	Silikon-Matte 500 x 230 mm, blau <i>silicon mat 500 x 230 mm, blue</i>
02-23-049	1x	CCR Basis Retraktor, Doppelgelenk <i>CCR basic retractor, double hinge</i>
02-23-047	1x	CCR Basis Gegensperrer <i>CCR basic counter retractor</i>
02-23-048	1x	CCR Gegensperrer <i>CCR counter retractor</i>
02-23-010	2x	Handgriff zum Einsetzen der Valven <i>handle for the insertion of blades</i>
02-23-011	1x	Tiefenmesser <i>depth gauge</i>
02-23-141T	1x	CCR Valve, lateral 24 x 30 mm <i>CCR blade, lateral 24 x 30 mm</i>
02-23-142T	1x	CCR Valve, lateral 24 x 35 mm <i>CCR blade, lateral 24 x 35 mm</i>
02-23-143T	1x	CCR Valve, lateral 24 x 40 mm <i>CCR blade, lateral 24 x 40 mm</i>
02-23-144T	1x	CCR Valve, lateral 24 x 45 mm <i>CCR blade, lateral 24 x 45 mm</i>
02-23-145T	1x	CCR Valve, lateral 24 x 50 mm <i>CCR blade, lateral 24 x 50 mm</i>
02-23-146T	1x	CCR Valve, lateral 24 x 55 mm <i>CCR blade, lateral 24 x 55 mm</i>
02-23-147T	1x	CCR Valve, lateral 24 x 60 mm <i>CCR blade, lateral 24 x 60 mm</i>
02-23-148T	1x	CCR Valve, lateral 24 x 65 mm <i>CCR blade, lateral 24 x 65 mm</i>
02-23-149T	1x	CCR Valve, lateral 24 x 70 mm <i>CCR blade, lateral 24 x 70 mm</i>
02-23-151T	1x	CCR Valve, medial 24 x 30 mm <i>CCR blade, medial 24 x 30 mm</i>
02-23-152T	1x	CCR Valve, medial 24 x 35 mm <i>CCR blade, medial 24 x 35 mm</i>
02-23-153T	1x	CCR Valve, medial 24 x 40 mm <i>CCR blade, medial 24 x 40 mm</i>
02-23-154T	1x	CCR Valve, medial 24 x 45 mm <i>CCR blade, medial 24 x 45 mm</i>
02-23-155T	1x	CCR Valve, medial 24 x 50 mm <i>CCR blade, medial 24 x 50 mm</i>
02-23-156T	1x	CCR Valve, medial 24 x 55 mm <i>CCR blade, medial 24 x 55 mm</i>
02-23-157T	1x	CCR Valve, medial 24 x 60 mm <i>CCR blade, medial 24 x 60 mm</i>
02-23-158T	1x	CCR Valve, medial 24 x 65 mm <i>CCR blade, medial 24 x 65 mm</i>
02-23-159T	1x	CCR Valve, medial 24 x 70 mm <i>CCR blade, medial 24 x 70 mm</i>
02-23-162T	1x	CCR Valve, stumpf 24 x 35 mm <i>CCR blade, blunt 24 x 35 mm</i>
02-23-163T	1x	CCR Valve, stumpf 24 x 40 mm <i>CCR blade, blunt 24 x 40 mm</i>
02-23-164T	1x	CCR Valve, stumpf 24 x 45 mm <i>CCR blade, blunt 24 x 45 mm</i>
02-23-165T	1x	CCR Valve, stumpf 24 x 50 mm <i>CCR blade, blunt 24 x 50 mm</i>
02-23-166T	1x	CCR Valve, stumpf 24 x 55 mm <i>CCR blade, blunt 24 x 55 mm</i>
02-23-167T	1x	CCR Valve, stumpf 24 x 60 mm <i>CCR blade, blunt 24 x 60 mm</i>
02-23-168T	1x	CCR Valve, stumpf 24 x 65 mm <i>CCR blade, blunt 24 x 65 mm</i>
02-23-169T	1x	CCR Valve, stumpf 24 x 70 mm <i>CCR blade, blunt 24 x 70 mm</i>
02-23-170T	1x	CCR Valve, stumpf 24 x 75 mm <i>CCR blade, blunt 24 x 75 mm</i>

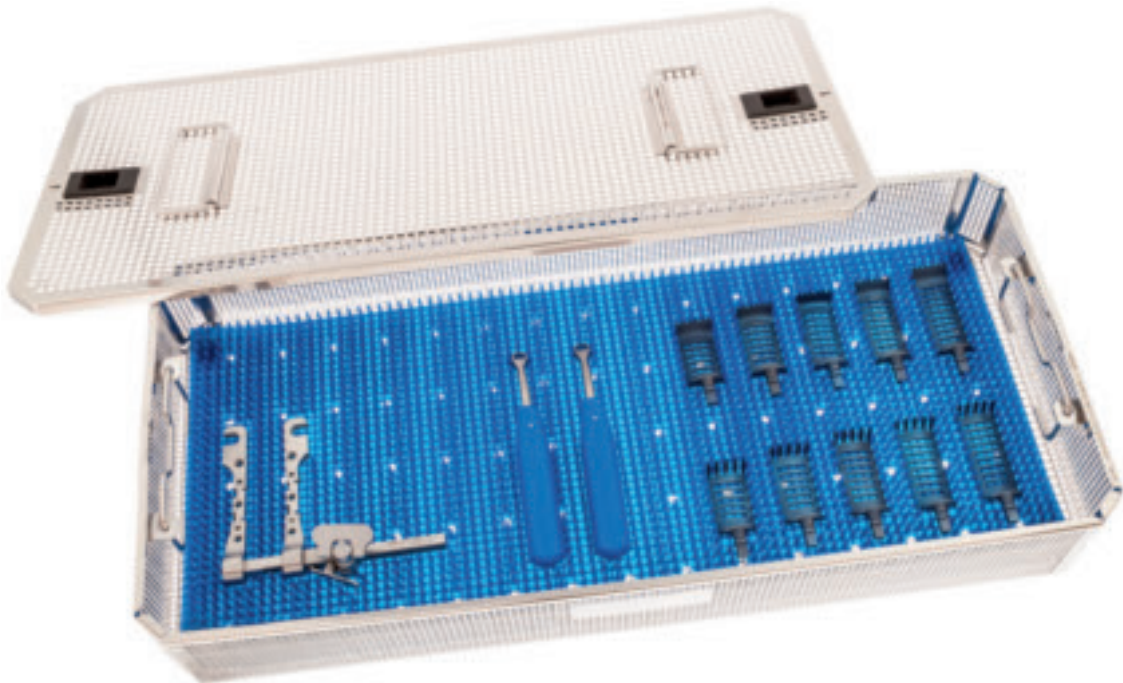

Artikel-Nr.
Cat. No.

02-23-122

CCR Basis Retraktor Set, bestehend aus:
CCR Basic Retractor Set, consisting of:

10-07-224 1x Siebkorb 545 x 255 x 100 mm aus Edelstahl
basket 545 x 255 x 100 mm,
stainless steel screen

10-06-227 1x Deckel zu Siebkorb 545 x 255 mm
aus Edelstahl, mit Verschluss
lid for basket 545 x 255 mm with closure,
stainless steel screen

10-56-933 1x Silikon-Matte 500 x 230 mm, blau
silicon mat 500 x 230 mm, blue

02-23-049 1x CCR Basis Retraktor, Doppelgelenk
CCR basic retractor, double hinge

02-23-010 2x Handgriff zum Einsetzen der Valven
handle for the insertion of blades

02-23-143T 1x CCR Valve, lateral 24 x 40 mm
CCR blade, lateral 24 x 40 mm

02-23-144T 1x CCR Valve, lateral 24 x 45 mm
CCR blade, lateral 24 x 45 mm

02-23-145T 1x CCR Valve, lateral 24 x 50 mm
CCR blade, lateral 24 x 50 mm

02-23-146T 1x CCR Valve, lateral 24 x 55 mm
CCR blade, lateral 24 x 55 mm

02-23-147T 1x CCR Valve, lateral 24 x 60 mm
CCR blade, lateral 24 x 60 mm

02-23-153T 1x CCR Valve, medial 24 x 40 mm
CCR blade, medial 24 x 40 mm

02-23-154T 1x CCR Valve, medial 24 x 45 mm
CCR blade, medial 24 x 45 mm

02-23-155T 1x CCR Valve, medial 24 x 50 mm
CCR blade, medial 24 x 50 mm

02-23-156T 1x CCR Valve, medial 24 x 55 mm
CCR blade, medial 24 x 55 mm

02-23-157T 1x CCR Valve, medial 24 x 60 mm
CCR blade, medial 24 x 60 mm



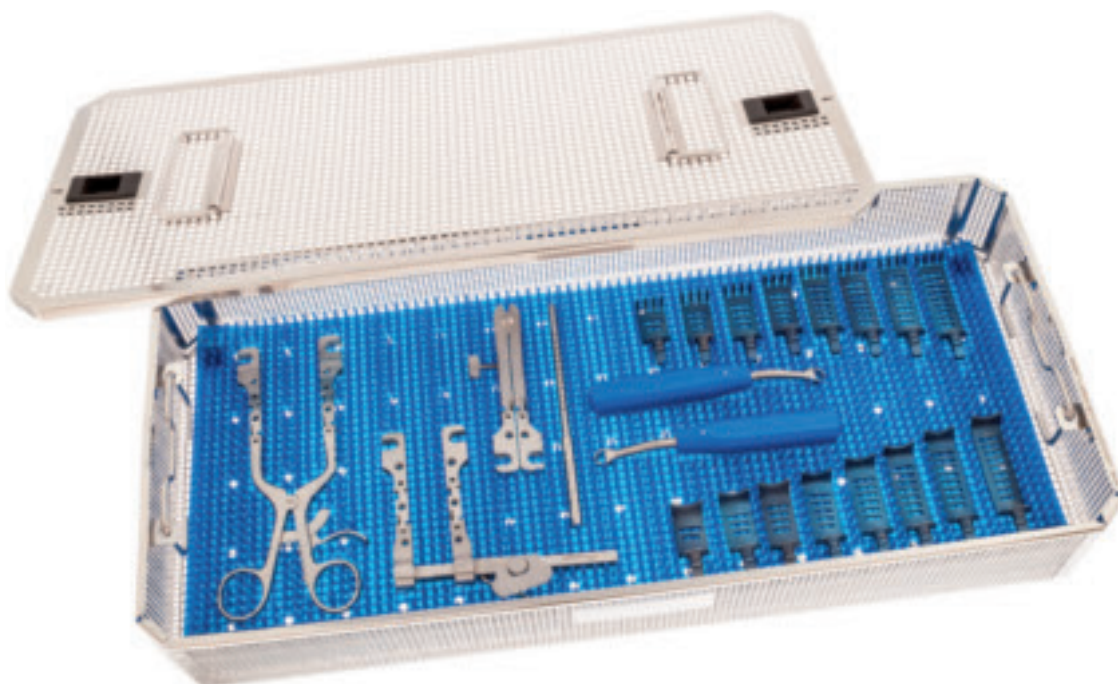

Artikel-Nr.
Cat. No.

02-23-119	CCR Retraktor Set für mikrochirurgische Eingriffe, bestehend aus: CCR Retractor Set for micro surgical intervention, consisting of:	
10-07-224	2x	Siebkorb 545 x 255 x 100 mm aus Edelstahl <i>basket 545 x 255 x 100 mm, stainless steel screen</i>
10-06-227	2x	Deckel zu Siebkorb 545 x 255 mm aus Edelstahl, mit Verschluss <i>lid for basket 545 x 255 mm, with closure, stainless steel screen</i>
10-56-933	2x	Silikon-Matte 500 x 230 mm, blau <i>silicon mat 500 x 230 mm, blue</i>
02-23-049	1x	CCR Basis Retraktor, Doppelgelenk <i>CCR basic retractor, double hinge</i>
02-23-047	1x	CCR Basis Gegensperrer <i>CCR basic counter retractor</i>
02-23-048	1x	Gegensperrer <i>counter retractor</i>
02-23-010	2x	Handgriff zum Einsetzen der Valven <i>handle for the insertion of blades</i>
02-23-011	1x	Tiefenmesser <i>depth gauge</i>
02-23-050T	2x	CCR Valve, gezahnt 19 x 25 mm <i>CCR blade, toothed 19 x 25 mm</i>
02-23-051T	2x	CCR Valve, gezahnt 19 x 30 mm <i>CCR blade, toothed 19 x 30 mm</i>
02-23-052T	2x	CCR Valve, gezahnt 19 x 35 mm <i>CCR blade, toothed 19 x 35 mm</i>
02-23-053T	2x	CCR Valve, gezahnt 19 x 40 mm <i>CCR blade, toothed 19 x 40 mm</i>
02-23-054T	2x	CCR Valve, gezahnt 19 x 45 mm <i>CCR blade, toothed 19 x 45 mm</i>
02-23-055T	2x	CCR Valve, gezahnt 19 x 50 mm <i>CCR blade, toothed 19 x 50 mm</i>
02-23-056T	2x	CCR Valve, gezahnt 19 x 55 mm <i>CCR blade, toothed 19 x 55 mm</i>
02-23-057T	2x	CCR Valve, gezahnt 19 x 60 mm <i>CCR blade, toothed 19 x 60 mm</i>
02-23-060T	1x	CCR Valve, stumpf 19 x 25 mm <i>CCR blade, blunt 19 x 25 mm</i>
02-23-061T	1x	CCR Valve, stumpf 19 x 30 mm <i>CCR blade, blunt 19 x 30 mm</i>
02-23-062T	1x	CCR Valve, stumpf 19 x 35 mm <i>CCR blade, blunt 19 x 35 mm</i>
02-23-063T	1x	CCR Valve, stumpf 19 x 40 mm <i>CCR blade, blunt 19 x 40 mm</i>
02-23-064T	1x	CCR Valve, stumpf 19 x 45 mm <i>CCR blade, blunt 19 x 45 mm</i>
02-23-065T	1x	CCR Valve, stumpf 19 x 50 mm <i>CCR blade, blunt 19 x 50 mm</i>
02-23-066T	1x	CCR Valve, stumpf 19 x 55 mm <i>CCR blade, blunt 19 x 55 mm</i>
02-23-067T	1x	CCR Valve, stumpf 19 x 60 mm <i>CCR blade, blunt 19 x 60 mm</i>

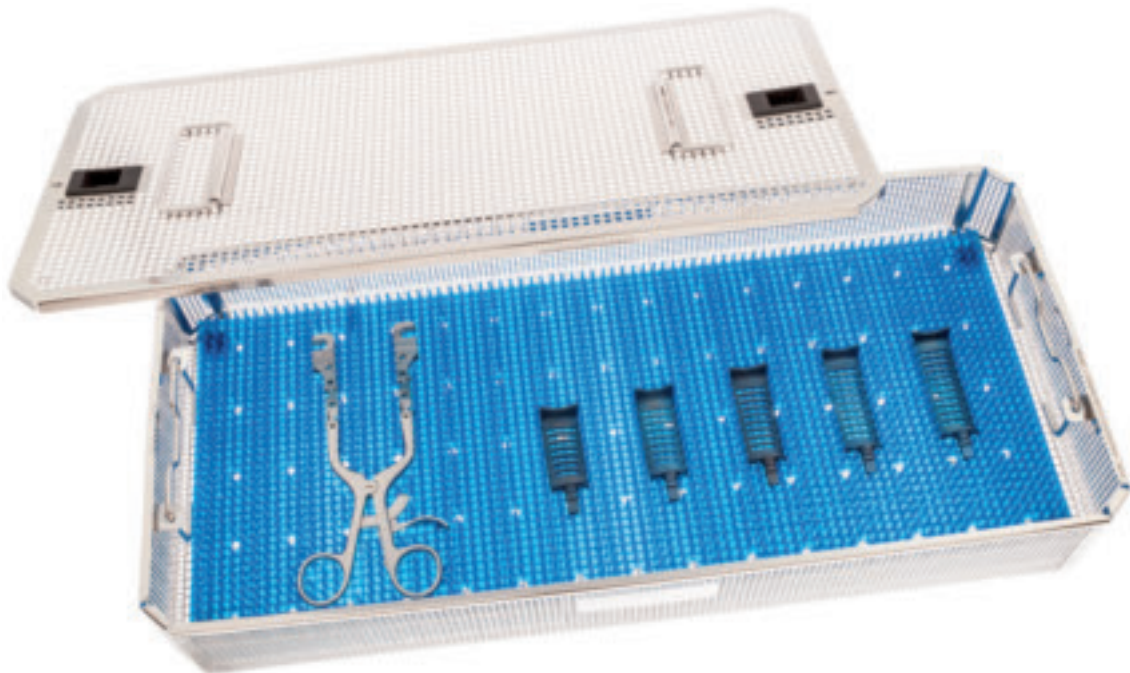

Artikel-Nr.
Cat. No.

02-23-123	CCR Basis-Gegensperrer Set, bestehend aus: CCR Basic Counter Retractor, set consisting of:	
10-07-224	1x	Siebkorb 545 x 255 x 100 mm aus Edelstahl <i>basket 545 x 255 x 100 mm, stainless steel screen</i>
10-06-227	1x	Deckel zu Siebkorb 545 x 255 mm, aus Edelstahl, mit Verschluss <i>lid for basket 545 x 255 mm, with closure, stainless steel screen</i>
10-56-933	1x	Silikon-Matte 500 x 230 mm, blau <i>silicon mat 500 x 230 mm, blue</i>
02-23-047	1x	CCR Basis Gegensperrer <i>CCR basic counter retractor</i>
02-23-164T	1x	CCR Valve, stumpf 24 x 45 mm <i>CCR blade, blunt 24 x 45 mm</i>
02-23-165T	1x	CCR Valve, stumpf 24 x 50 mm <i>CCR blade, blunt 24 x 50 mm</i>
02-23-166T	1x	CCR Valve, stumpf 24 x 55 mm <i>CCR blade, blunt 24 x 55 mm</i>
02-23-167T	1x	CCR Valve, stumpf 24 x 60 mm <i>CCR blade, blunt 24 x 60 mm</i>
02-23-168T	1x	CCR Valve, stumpf 24 x 65 mm <i>CCR blade, blunt 24 x 65 mm</i>



Artikel-Nr.
Cat. No.

	CASPAR	02-23-049	CCR Basis Retraktor mit Doppelgelenk, Spreizweite 90 mm <i>CCR basic retractor, double hinge, spread 90 mm</i> (ohne Valven / without blades)
--	---------------	------------------	---

CASPAR
02-23-049

Artikel-Nr.
Cat. No.

	CASPAR	02-23-047	CCR Basis Gegensperrer mit Doppelgelenk, Spreizweite 90 mm <i>CCR basic counter retractor, double hinge, spread 90 mm</i> (ohne Valven / without blades)
--	---------------	------------------	--

CASPAR
02-23-047

Artikel-Nr.
Cat. No.

02-23-048	CCR Gegensperrer, Spreizweite 90 mm <i>CCR counter retractor, spread 90 mm</i> (ohne Valven / <i>without blades</i>)	CASPAR	
-----------	---	--------	--



CASPAR
02-23-048

Artikel-Nr.
Cat. No.

02-23-010	Handgriff zum Einsetzen der Valven auch verwendbar als Wundhaken in Verbindung mit CCR-Valven <i>handle for the insertion of blades</i> <i>also for use as retractor with CCR blades</i>		
-----------	--	--	--



02-23-010

Artikel-Nr.
Cat. No.

02-23-011	Tiefenmesser zur Bestimmung der Valvenlänge <i>depth gauge for determining the</i> <i>length of the blades</i>		
-----------	---	--	--



02-23-011

 1/1
02-23-055T
 19 x 50 mm

Valven gezahnt, medial-lateral, semi-röntgentransparent, TITAN
 Blades toothed, medial-lateral, semi x-ray transparent, TITANIUM

TITAN

Artikel-Nr. Cat. No.	Maße B x L Measurements W x L
02-23-050T	19 x 25 mm
02-23-051T	19 x 30 mm
02-23-052T	19 x 35 mm
02-23-053T	19 x 40 mm
02-23-054T	19 x 45 mm
02-23-055T	19 x 50 mm
02-23-056T	19 x 55 mm
02-23-057T	19 x 60 mm



7

Valven stumpf, longitudinal, semi-röntgentransparent, TITAN
 Blades blunt, longitudinal, semi x-ray transparent, TITANIUM

TITAN

Artikel-Nr. Cat. No.	Maße B x L Measurements W x L
02-23-060T	19 x 25 mm
02-23-061T	19 x 30 mm
02-23-062T	19 x 35 mm
02-23-063T	19 x 40 mm
02-23-064T	19 x 45 mm
02-23-065T	19 x 50 mm
02-23-066T	19 x 55 mm
02-23-067T	19 x 60 mm

 1/1
02-23-065T
 19 x 50 mm

Valven lateral, semi röntgentransparent, TITAN
Blades lateral, semi x-ray transparent, TITANIUM

TITAN

Artikel-Nr. Cat. No.	Maße B x L Measurements W x L
02-23-141T	24 x 30 mm
02-23-142T	24 x 35 mm
02-23-143T	24 x 40 mm
02-23-144T	24 x 45 mm
02-23-145T	24 x 50 mm
02-23-146T	24 x 55 mm
02-23-147T	24 x 60 mm
02-23-148T	24 x 65 mm
02-23-149T	24 x 70 mm



1/1
02-23-145T
24 x 50 mm

Valven medial, semi-röntgentransparent, TITAN
Blades medial, semi x-ray transparent, TITANIUM

TITAN

Artikel-Nr. Cat. No.	Maße B x L Measurements W x L
02-23-151T	24 x 30 mm
02-23-152T	24 x 35 mm
02-23-153T	24 x 40 mm
02-23-154T	24 x 45 mm
02-23-155T	24 x 50 mm
02-23-156T	24 x 55 mm
02-23-157T	24 x 60 mm
02-23-158T	24 x 65 mm
02-23-159T	24 x 70 mm



1/1
02-23-155T
24 x 50 mm

Valven stumpf, longitudinal, semi-röntgentransparent, TITAN
Blades blunt, longitudinal, semi x-ray transparent, TITANIUM

TITAN

Artikel-Nr. Cat. No.	Maße B x L Measurements W x L
02-23-162T	24 x 35 mm
02-23-163T	24 x 40 mm
02-23-164T	24 x 45 mm
02-23-165T	24 x 50 mm
02-23-166T	24 x 55 mm
02-23-167T	24 x 60 mm
02-23-168T	24 x 65 mm
02-23-169T	24 x 70 mm
02-23-170T	24 x 75 mm



1/1
02-23-165T
24 x 50 mm

Solid TITAN Valven
Solid TITANIUM blades

 1/1
02-23-255T
 19 x 50 mm

Valven gezahnt, medial-lateral, semi-röntgentransparent, TITAN-
 Blades toothed, medial-lateral, semi x-ray transparent, TITANIUM

TITAN

Artikel-Nr. Cat. No.	Maße B x L Measurements W x L
02-23-250T	19 x 25 mm
02-23-251T	19 x 30 mm
02-23-252T	19 x 35 mm
02-23-253T	19 x 40 mm
02-23-254T	19 x 45 mm
02-23-255T	19 x 50 mm
02-23-256T	19 x 55 mm
02-23-257T	19 x 60 mm

Valven stumpf, longitudinal, semi-röntgentransparent, TITAN
 Blades blunt, longitudinal, semi x-ray transparent, TITANIUM

TITAN

Artikel-Nr. Cat. No.	Maße B x L Measurements W x L
02-23-260T	19 x 25 mm
02-23-261T	19 x 30 mm
02-23-262T	19 x 35 mm
02-23-263T	19 x 40 mm
02-23-264T	19 x 45 mm
02-23-265T	19 x 50 mm
02-23-266T	19 x 55 mm
02-23-267T	19 x 60 mm

 1/1
02-23-265T
 19 x 50 mm

Valven lateral, semi röntgentransparent, TITAN
Blades lateral, semi x-ray transparent, TITANIUM

TITAN

Artikel-Nr. Cat. No.	Maße B x L Measurements W x L
02-23-341T	24 x 30 mm
02-23-342T	24 x 35 mm
02-23-343T	24 x 40 mm
02-23-344T	24 x 45 mm
02-23-345T	24 x 50 mm
02-23-346T	24 x 55 mm
02-23-347T	24 x 60 mm
02-23-348T	24 x 65 mm
02-23-349T	24 x 70 mm

Solid TITAN Valven
Solid TITANIUM blades



1/1
02-23-345T
24 x 50 mm

Valven medial, semi-röntgentransparent, TITAN
Blades medial, semi x-ray transparent, TITANIUM

TITAN

Artikel-Nr. Cat. No.	Maße B x L Measurements W x L
02-23-351T	24 x 30 mm
02-23-352T	24 x 35 mm
02-23-353T	24 x 40 mm
02-23-354T	24 x 45 mm
02-23-355T	24 x 50 mm
02-23-356T	24 x 55 mm
02-23-357T	24 x 60 mm
02-23-358T	24 x 65 mm
02-23-359T	24 x 70 mm



1/1
02-23-355T
24 x 50 mm

Valven stumpf, longitudinal, semi-röntgentransparent, TITAN
Blades blunt, longitudinal, semi x-ray transparent, TITANIUM

TITAN

Artikel-Nr. Cat. No.	Maße B x L Measurements W x L
02-23-362T	24 x 35 mm
02-23-363T	24 x 40 mm
02-23-364T	24 x 45 mm
02-23-365T	24 x 50 mm
02-23-366T	24 x 55 mm
02-23-367T	24 x 60 mm
02-23-368T	24 x 65 mm
02-23-369T	24 x 70 mm
02-23-370T	24 x 75 mm



1/1
02-23-365T
24 x 50 mm

Artikel-Nr.
 Cat. No.

 1/2
 CASPAR
 02-22-460

CASPAR

02-22-460

**Zervikal-Sperrer, Spreizweite 90 mm,
 komplett, bestehend aus:**
*Cervical Retractor, spread 90 mm,
 complete, consisting of:*

- | | | |
|------------------|------------|---|
| 02-22-439 | 1 x | Zervikal Sperrer, allein
<i>cervical retractor, only</i> |
| 02-22-772 | 1 x | Valve medial, 23 x 40 mm
<i>blade medial, 23 x 40 mm</i> |
| 02-22-773 | 1 x | Valve medial, 23 x 45 mm
<i>blade medial, 23 x 45 mm</i> |
| 02-22-774 | 1 x | Valve medial, 23 x 50 mm
<i>blade medial, 23 x 50 mm</i> |
| 02-22-775 | 1 x | Valve medial, 23 x 55 mm
<i>blade medial, 23 x 55 mm</i> |
| 02-22-776 | 1 x | Valve medial, 23 x 60 mm
<i>blade medial, 23 x 60 mm</i> |
| 02-22-792 | 1 x | Valve lateral, 23 x 40 mm
<i>blade lateral, 23 x 40 mm</i> |
| 02-22-793 | 1 x | Valve lateral, 23 x 45 mm
<i>blade lateral, 23 x 45 mm</i> |
| 02-22-794 | 1 x | Valve lateral, 23 x 50 mm
<i>blade lateral, 23 x 50 mm</i> |
| 02-22-795 | 1 x | Valve lateral, 23 x 55 mm
<i>blade lateral, 23 x 55 mm</i> |
| 02-22-796 | 1 x | Valve lateral, 23 x 60 mm
<i>blade lateral, 23 x 60 mm</i> |

 1/2
 CASPAR
 02-22-490

CASPAR

 Artikel-Nr.
 Cat. No.

02-22-490

**Zervikal Gegensperrer, Spreizweite 90 mm,
 komplett, bestehend aus:**
*Cervical Counter Retractor, spread 90 mm,
 complete, consisting of:*

- | | | |
|------------------|------------|--|
| 02-22-491 | 1 x | Zervikal Gegensperrer, allein
<i>cervical counter retractor, only</i> |
| 02-22-783 | 1 x | Valve stumpf, 23 x 45 mm
<i>blade blunt, 23 x 45 mm</i> |
| 02-22-784 | 1 x | Valve stumpf, 23 x 50 mm
<i>blade blunt, 23 x 50 mm</i> |
| 02-22-785 | 1 x | Valve stumpf, 23 x 55 mm
<i>blade blunt, 23 x 55 mm</i> |
| 02-22-786 | 1 x | Valve stumpf, 23 x 60 mm
<i>blade blunt, 23 x 60 mm</i> |
| 02-22-787 | 1 x | Valve stumpf, 23 x 65 mm
<i>blade blunt, 23 x 65 mm</i> |

Artikel-Nr.
 Cat. No.

02-22-780	Zervikal Gegensperrerr, Spreizweite 90 mm, komplett, bestehend aus: <i>Cervical Counter Retractor, spread 90 mm, complete, consisting of:</i>	CASPAR	
02-22-771	1 x Zervikal Gegensperrerr, allein <i>cervical counter retractor, only</i>		
02-22-783	1 x Valve stumpf, 23 x 45 mm, <i>blade blunt, 23 x 45 mm</i>		
02-22-784	1 x Valve stumpf, 23 x 50 mm <i>blade blunt, 23 x 50 mm</i>		
02-22-785	1 x Valve stumpf, 23 x 55 mm <i>blade blunt, 23 x 55 mm</i>		
02-22-786	1 x Valve stumpf, 23 x 60 mm <i>blade blunt, 23 x 60 mm</i>		
02-22-787	1 x Valve stumpf, 23 x 65 mm <i>blade blunt, 23 x 65 mm</i>		

1/2
CASPAR
02-22-789

Artikel-Nr.
 Cat. No.

02-22-399	Blätter-Wechselpinzette <i>blade ejector</i>		
------------------	--	--	---

1/2
02-22-399

TITAN
Artikel-Nr.
Cat. No.
Maße B x L
Measurements W x L

 1/1
02-22-884T
 24 x 50 mm

02-22-879T
02-22-880T
02-22-881T
02-22-882T
02-22-883T
02-22-884T
02-22-885T
02-22-886T
02-22-887T
02-22-888T

 24 x 25 mm
 24 x 30 mm
 24 x 35 mm
 24 x 40 mm
 24 x 45 mm
 24 x 50 mm
 24 x 55 mm
 24 x 60 mm
 24 x 65 mm
 24 x 70 mm

 Valven, medial, gefenstert, TITAN
 für Sperrer 02-22-439, 02-22-491, 02-22-771

blades, medial, fenestrated, TITANIUM
for retractors 02-22-439, 02-22-491,
02-22-771

 1/1
02-22-892T
 24 x 40 mm

02-22-889T
02-22-890T
02-22-891T
02-22-892T
02-22-893T
02-22-894T
02-22-895T
02-22-896T
02-22-897T
02-22-898T

 24 x 25 mm
 24 x 30 mm
 24 x 35 mm
 24 x 40 mm
 24 x 45 mm
 24 x 50 mm
 24 x 55 mm
 24 x 60 mm
 24 x 65 mm
 24 x 70 mm

 Valven, lateral, gefenstert, TITAN
 für Sperrer 02-22-439, 02-22-491, 02-22-771

blades, lateral, fenestrated, TITANIUM
for retractors 02-22-439, 02-22-491,
02-22-771





 1/1
02-22-783T
 24 x 45 mm

02-22-779T
02-22-781T
02-22-782T
02-22-783T
02-22-784T
02-22-785T
02-22-786T
02-22-787T
02-22-788T
02-22-789T

 24 x 30 mm
 24 x 35 mm
 24 x 40 mm
 24 x 45 mm
 24 x 50 mm
 24 x 55 mm
 24 x 60 mm
 24 x 65 mm
 24 x 70 mm
 24 x 75 mm

 Valven, stumpf, TITAN
 für Sperrer 02-22-439, 02-22-491, 02-22-771

blades, blunt, TITANIUM
for retractors 02-22-439, 02-22-491,
02-22-771

Artikel-Nr. Cat. No.	Maße B x L Measurements W x L	
02-22-772	23 x 40 mm	 <p>1/1 02-22-775 23 x 55 mm</p>
02-22-773	23 x 45 mm	
02-22-774	23 x 50 mm	
02-22-775	23 x 55 mm	
02-22-776	23 x 60 mm	
	Valven, medial, für Sperrer 02-22-439, 02-22-491, 02-22-771 blades, medial, for retractors 02-22-439, 02-22-491, 02-22-771	
02-22-792	23 x 40 mm	 <p>1/1 02-22-794 23 x 50 mm</p>
02-22-793	23 x 45 mm	
02-22-794	23 x 50 mm	
02-22-795	23 x 55 mm	
02-22-796	23 x 60 mm	
	Valven, lateral, für Sperrer 02-22-439, 02-22-491, 02-22-771 blades, lateral, for retractors 02-22-439, 02-22-491, 02-22-771	
02-22-783	23 x 45 mm	 <p>1/1 02-22-783 23 x 45 mm</p>
02-22-784	23 x 50 mm	
02-22-785	23 x 55 mm	
02-22-786	23 x 60 mm	
02-22-787	23 x 65 mm	
	Valven, stumpf, für Sperrer 02-22-439, 02-22-491, 02-22-771 blades, blunt, for retractors 02-22-439, 02-22-491, 02-22-771	
02-22-764	25 x 50 mm	 <p>1/1 02-22-764 25 x 50 mm</p>
02-22-766	25 x 60 mm	
	Valven, stumpf, für Sperrer 02-22-439, 02-22-491, 02-22-771 blades, blunt, for retractors 02-22-439, 02-22-491, 02-22-771	

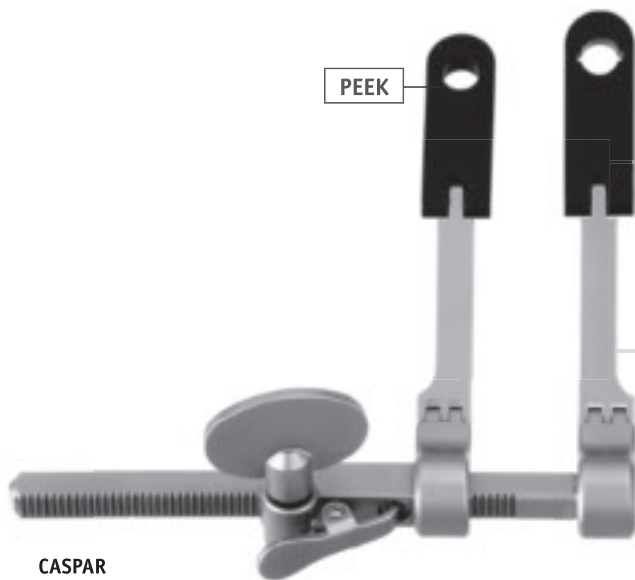

 CASPAR
 02-23-049P

 Artikel-Nr.
 Cat. No.

CASPAR

02-23-049P

 CCR Zervikal Sperrer mit Doppelgelenk und
 röntgentransparenten PEEK Armen

*CCR cervical retractor with double hinge and
 x-ray transparent PEEK arms*

 CASPAR
 02-23-047P

 Artikel-Nr.
 Cat. No.

CASPAR

02-23-047P

 CCR Basis Gegensperrer mit Doppelgelenk
 und röntgentransparenten PEEK Armen

*CCR cervical counter retractor with double
 hinge and x-ray transparent PEEK arms*

Artikel-Nr.
 Cat. No.

02-22-439P	CCR Zervikal Sperrer mit röntgentransparenten PEEK Armen <i>CCR cervical retractor with x-ray transparent PEEK arms</i>
------------	--

CASPAR

PEEK



CASPAR
 02-22-439P

Artikel-Nr.
 Cat. No.

02-22-491P	CCR Basis Gegensperrer mit röntgentransparenten PEEK Armen <i>CCR cervical counter retractor with x-ray transparent PEEK arms</i>
------------	--

CASPAR

PEEK



CASPAR
 02-22-491P

 CASPAR
 02-22-771P

Artikel-Nr.
Cat. No.

CASPAR

02-22-771P

 CCR Gegensperrer mit röntgen-
 transparenten PEEK Armen

 CCR counter retractor with x-ray transparent
 PEEK arms

7

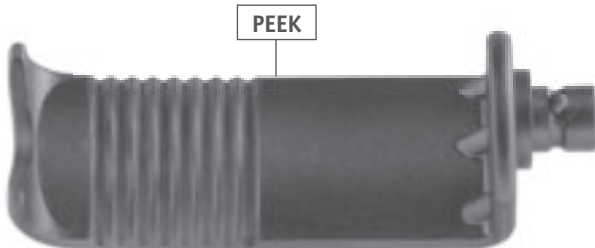
PEEK Valve stumpf, röntgentransparent
PEEK blade blunt, x-ray transparent

 1/1
 02-22-786P
 23 x 60 mm

Artikel-Nr.
Cat. No.
Maße B x L
Measurements W x L

02-72-782P

23 x 40 mm

02-22-783P

23 x 45 mm

02-22-784P

23 x 50 mm

02-22-785P

23 x 55 mm

02-22-786P

23 x 60 mm

02-22-787P

23 x 65 mm

02-72-788P

23 x 75 mm

PEEK Valve lateral, röntgentransparent
PEEK blade lateral, x-ray transparent

Artikel-Nr. Cat. No.	Maße B x L Measurements W x L
02-22-792P	23 x 40 mm
02-22-793P	23 x 45 mm
02-22-794P	23 x 50 mm
02-22-795P	23 x 55 mm
02-22-796P	23 x 60 mm
02-72-797P	23 x 65 mm
02-72-798P	23 x 75 mm

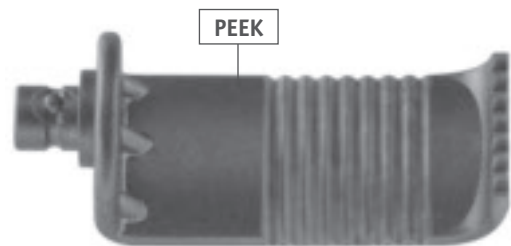

1/1
02-22-794P
 23 x 50 mm

PEEK Valve medial, röntgentransparent
PEEK blade medial, x-ray transparent

Artikel-Nr. Cat. No.	Maße B x L Measurements W x L
02-22-772P	23 x 40 mm
02-22-773P	23 x 45 mm
02-22-774P	23 x 50 mm
02-22-775P	23 x 55 mm
02-22-776P	23 x 60 mm
02-72-777P	23 x 65 mm
02-72-778P	23 x 75 mm

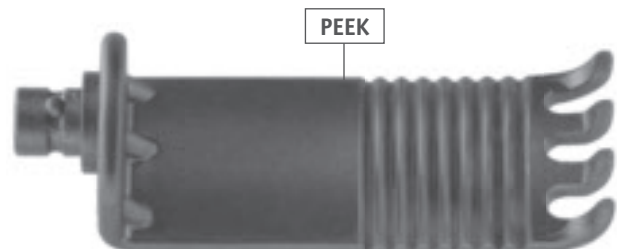

1/1
02-22-776P
 23 x 60 mm

Vorteile:

- Retraktor System für Mikro Lumbale Eingriffe
- Kleiner Zugang
- Spekula mit vergrößerter distaler Spreizweite
- Gegensperrer mit Doppelgelenk für flexiblen Einsatz
- Laterale und mediale Valven in der Tiefe zusätzlich spreizbar
- Umlegbare Flügelschraube

Advantages:

- retractor system for micro lumbar discectomy
- small access
- specula with enlarged distal spreading
- double hinged counter retractor for flexible handling
- lateral and medial blades can be additionally spreaded in the depth
- reversible wing screw



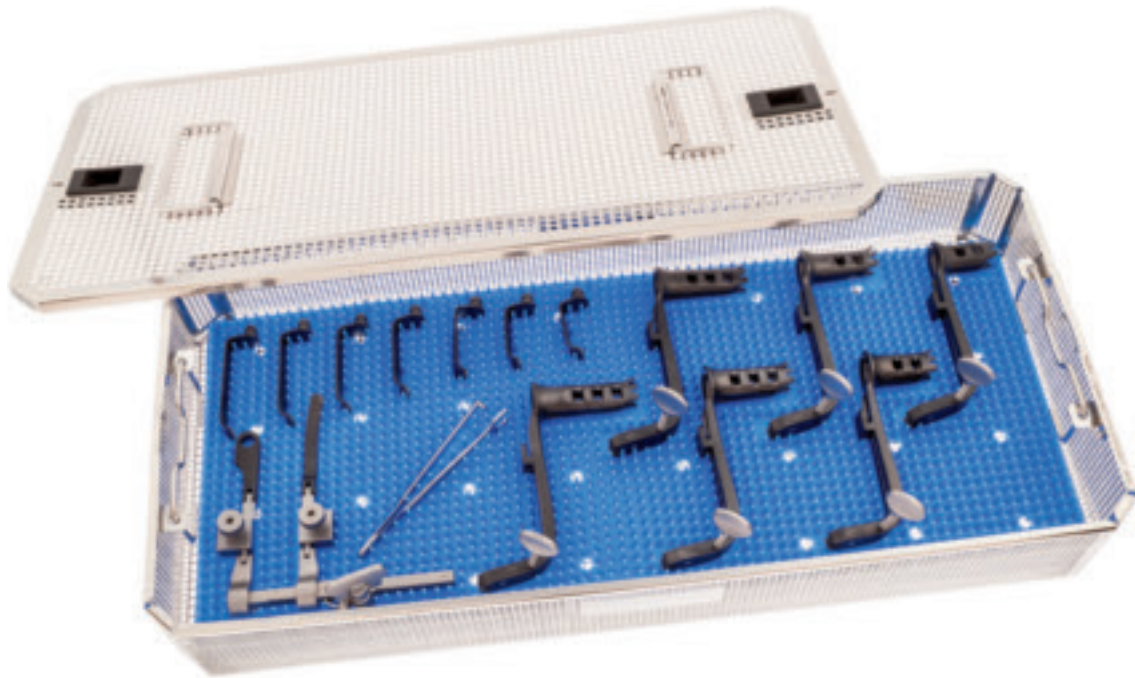

Artikel-Nr.
 Cat. No.

06-57-170

Mikrodiskektomie Retraktor Set mit erweiterter Tiefenspreizung, komplett, bestehend aus:
Micro Discectomy Retractor Set with extended deep spreading, complete, consisting of:

10-07-223 1x Siebkorb 545 x 255 x 70 mm,
 aus Edelstahl
*wire basket 545 x 255 x 70 mm,
 stainless steel*

10-06-227 1x Deckel zu Siebkorb 545 x 255 mm,
 aus Edelstahl, mit Verschluss
*lid for basket 545 x 255 mm,
 with closure, stainless steel*

10-56-933 1x Silikon-Matte 500 x 230 mm, blau
silicon mat 500 x 230 mm, blue

02-72-799 1x Spekula 40 mm
specula 40 mm

02-72-800 1x Spekula 45 mm
specula 45 mm

02-72-801 1x Spekula 50 mm
specula 50 mm

02-72-802 1x Spekula 55 mm
specula 55 mm

02-72-803 1x Spekula 60 mm
specula 60 mm

02-72-804 1x Spekula 65 mm
specula 65 mm

02-72-812 1x Gegensperrer, allein
counter retractor, only

02-22-870 1x Valve 35 mm
blade 35 mm

02-22-871 1x Valve 40 mm
blade 40 mm

02-22-872 1x Valve 45 mm
blade 45 mm

02-22-873 1x Valve 50 mm
blade 50 mm

02-22-874 1x Valve 55 mm
blade 55 mm

02-22-875 1x Valve 60 mm
blade 60 mm

02-22-876 1x Valve 65 mm
blade 65 mm

02-22-399 1x Blätter-Wechselpinzette
blade ejector

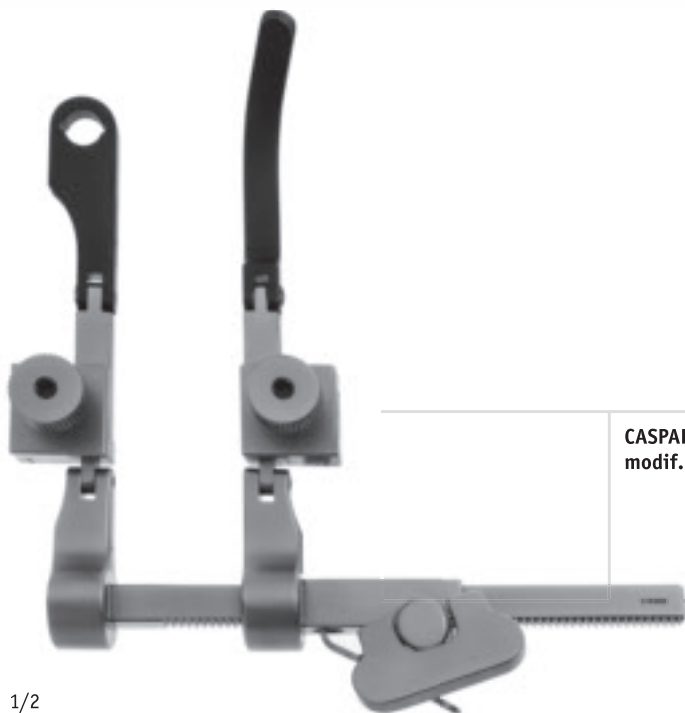

7

Artikel-Nr.
Cat. No.
CASPAR
modif.
02-72-812

 Gegensperrer mit Doppelgelenk und
 tiefenverstellbaren Armen, schwarz,
 titanbeschichtet

*double hinge counter retractor with
 deep spreading arm, black, titanium-coated*

 1/2
CASPAR modif.
02-72-812

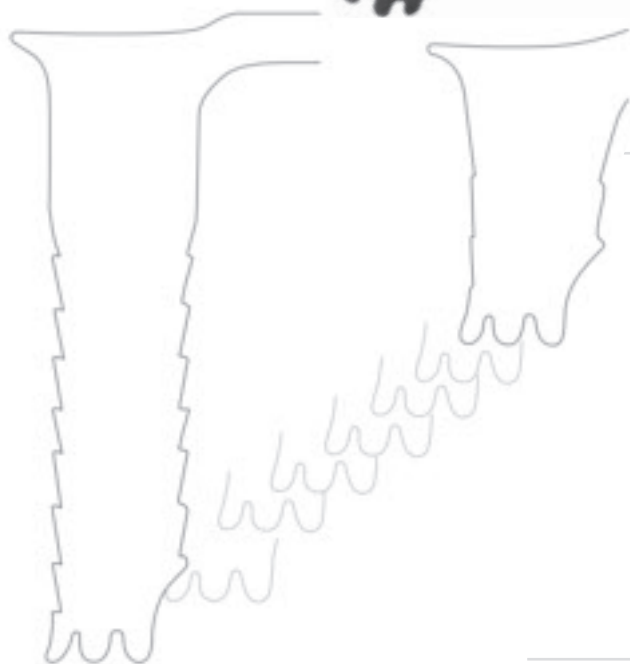
 1/1
02-72-804
 65 mm
 2½"

Artikel-Nr.
Cat. No.
Blattlänge
Length of blades
02-72-799

40 mm / 1½"

02-72-800

45 mm / 1¾"

02-72-801

50 mm / 2"

02-72-802

55 mm / 2⅛"

02-72-803

60 mm / 2¼"

02-72-804

65 mm / 2½"

02-72-806

75 mm / 3"

02-72-808

85 mm / 3¼"

 Spekula, schwarz, titanbeschichtet
 mit erweiterter Tiefenspreizung
*specula, black, titanium-coated
 with extended deep spreading*

Artikel-Nr. Cat. No.	Blattlänge Length of blades
02-22-870	35 mm / 1¼"
02-22-871	40 mm / 1½"
02-22-872	45 mm / 1¾"
02-22-873	50 mm / 2"
02-22-874	55 mm / 2⅛"
02-22-875	60 mm / 2¼"
02-22-876	65 mm / 2½"
02-22-877	75 mm / 3"
02-22-878	85 mm / 3¼"
	Valve lateral, schwarz, titanbeschichtet, für Gegensperrer 02-72-812 und 02-22-812 <i>blade lateral, black, titanium-coated for counter retractor 02-72-812 and 02-22-812</i>
02-72-851	40 mm / 1½"
02-72-852	45 mm / 1¾"
02-72-853	50 mm / 2"
02-72-854	55 mm / 2⅛"
02-72-855	60 mm / 2¼"
02-72-856	65 mm / 2½"
02-72-857	70 mm / 2¾"
	Valve medial, schwarz, titanbeschichtet, für Gegensperrer 02-72-812 <i>blade medial, black, titanium-coated, for counter retractor 02-72-812</i>



1/1
02-22-873
 50 mm
 2"



1/1
02-72-851
 40 mm
 1½"

Artikel-Nr. Cat. No.	
02-22-399	Blätter-Wechselpinzette <i>blade ejector</i>

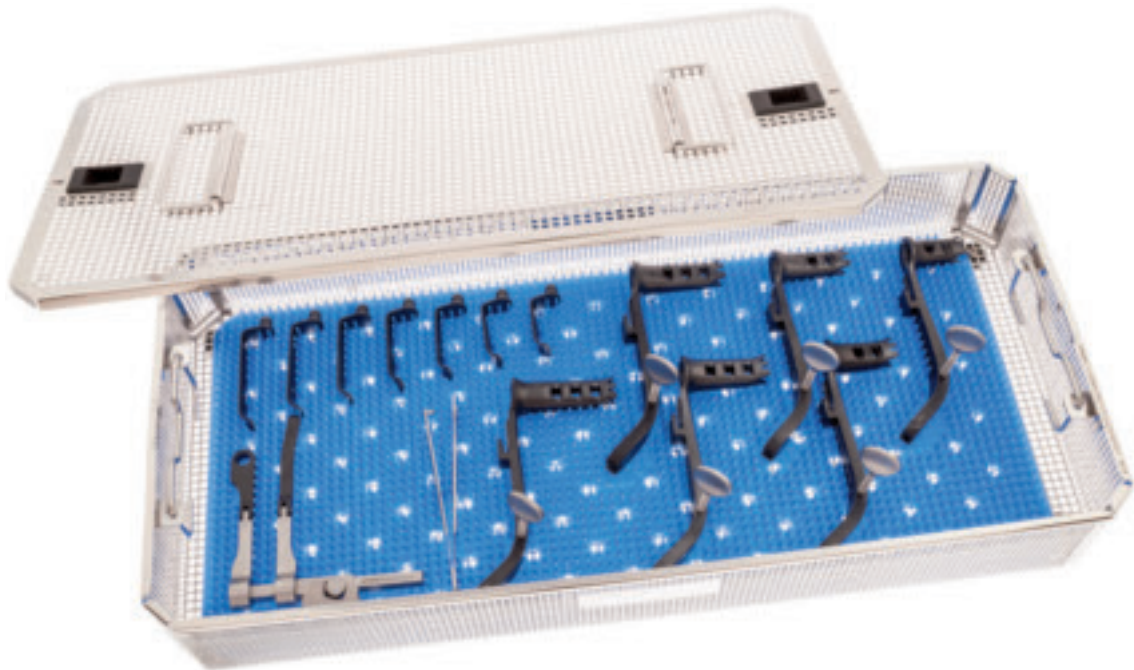

1/2
02-22-399

Artikel-Nr.
Cat. No.

CASPAR	06-07-170	Mikrodiskektomie Retraktor Set, komplett, bestehend aus: Micro Lumbar Discectomy Retractor Set, complete, consisting of:	
	10-07-223	1x Siebkorb 545 x 255 x 70 mm, aus Edelstahl <i>wire basket 545 x 255 x 70 mm, stainless steel</i>	02-22-812 1x Gegensperrer, allein <i>counter retractor, only</i>
	10-06-227	1x Deckel zu Siebkorb 545 x 255 mm, aus Edelstahl, mit Verschluss <i>lid for basket 545 x 255 mm, with closure, stainless steel</i>	02-22-870 1x Valve 35 mm <i>blade 35 mm</i>
	10-56-933	1x Silikon-Matte 500 x 230 mm, blau <i>silicon mat 500 x 230 mm, blue</i>	02-22-871 1x Valve 40 mm <i>blade 40 mm</i>
	02-22-799	1x Spekula 40 mm <i>specula 40 mm</i>	02-22-872 1x Valve 45 mm <i>blade 45 mm</i>
	02-22-800	1x Spekula 45 mm <i>specula 45 mm</i>	02-22-873 1x Valve 50 mm <i>blade 50 mm</i>
	02-22-801	1x Spekula 50 mm <i>specula 50 mm</i>	02-22-874 1x Valve 55 mm <i>blade 55 mm</i>
	02-22-802	1x Spekula 55 mm <i>specula 55 mm</i>	02-22-875 1x Valve 60 mm <i>blade 60 mm</i>
	02-22-803	1x Spekula 60 mm <i>specula 60 mm</i>	02-22-876 1x Valve 65 mm <i>blade 65 mm</i>
	02-22-804	1x Spekula 70 mm <i>specula 70 mm</i>	02-22-399 1x Blätter-Wechselpinzette <i>blade ejector</i>

Artikel-Nr.
 Cat. No.

<p>02-22-810</p>	<p>Gegensperrer, komplett mit 6 Valven 02-22-870 - 02-22-875 <i>counter retractor, complete with 6 blades</i> 02-22-870 - 02-22-875</p>	<p>CASPAR</p>
<p>02-22-812</p>	<p>Gegensperrer, allein, schwarz, titanbeschichtet <i>counter retractor, only,</i> black, titanium-coated</p>	<p>CASPAR</p>



2/3
CASPAR
 02-22-812

Artikel-Nr.
 Cat. No.

Blattlänge
 Length of blades

<p>02-22-870</p>	<p>35 mm / 1¼"</p>	
<p>02-22-871</p>	<p>40 mm / 1½"</p>	
<p>02-22-872</p>	<p>45 mm / 1¾"</p>	
<p>02-22-873</p>	<p>50 mm / 2"</p>	
<p>02-22-874</p>	<p>55 mm / 2⅛"</p>	
<p>02-22-875</p>	<p>60 mm / 2¼"</p>	
<p>02-22-876</p>	<p>65 mm / 2½"</p>	
<p>02-22-877</p>	<p>75 mm / 3"</p>	
<p>02-22-878</p>	<p>85 mm / 3¼"</p>	
<p>Valven, lateral, schwarz, titanbeschichtet, für Gegensperrer 02-22-812 und 02-72-812 <i>blades, lateral, black, titanium-coated,</i> for counter retractor 02-22-812 and 02-72-812</p>		
<p>02-22-851</p>	<p>40 mm / 1½"</p>	
<p>02-22-852</p>	<p>45 mm / 1¾"</p>	
<p>02-22-853</p>	<p>50 mm / 2"</p>	
<p>02-22-854</p>	<p>55 mm / 2⅛"</p>	
<p>02-22-855</p>	<p>60 mm / 2¼"</p>	
<p>02-22-856</p>	<p>65 mm / 2½"</p>	
<p>02-22-857</p>	<p>70 mm / 2¾"</p>	
<p>Valven, medial, schwarz, titanbeschichtet, für Gegensperrer 02-22-812 <i>blades, medial, black, titanium-coated,</i> for counter retractor 02-22-812</p>		



2/3
02-22-873
 50 mm
 2"



2/3
02-22-853
 50 mm
 2"



7

 2/3
CASPAR
02-22-801
 50 mm
 2"

Artikel-Nr.
Cat. No.
Blattlänge
Length of blades
CASPAR
02-22-799

40 mm / 1½"

02-22-800

45 mm / 1¾"

02-22-801

50 mm / 2"

02-22-802

55 mm / 2⅛"

02-22-803

60 mm / 2¼"

02-22-804

65 mm / 2½"

02-22-806

75 mm / 3"

02-22-808





85 mm / 3¼"

 Spekula, schwarz, titanbeschichtet
 specula, black, titanium-coated

Artikel-Nr.
Cat. No.

13-52-499	Ring Retraktor System komplett, bestehend aus: Ring Retractor System complete, consisting out of:
13-52-669	1 x Ring Retraktor Tischarretierung 300 mm, 12" <i>ring retractor table post 300 mm, 12"</i>
13-02-487	1 x Ring Retraktor, horizontale Stange <i>ring retractor, horizontal bar</i>
13-02-504	1 x Arretierkupplung \varnothing 25 mm, 1" <i>post coupling \varnothing 25 mm, 1"</i>
13-02-516	1 x Rahmen oval, mittel <i>ring oval, medium</i>
13-02-946	2 x Valve biegsam, flach, 51 x 152 mm <i>blade malleable, flat, 51 x 152 mm</i>
13-02-524	2 x KELLY Valve 51 x 76 mm <i>KELLY blade 51 x 76 mm</i>
13-02-525	1 x KELLY Valve 51 x 101 mm <i>KELLY blade 51 x 101 mm</i>
13-02-534	1 x BALFOUR Valve, schmal <i>BALFOUR blade, narrow</i>
13-02-503	2 x Rastmechanismus, standard <i>ratchet mechanism, standard</i>
13-02-510	6 x Rastmechanismus, kippbar <i>tilt ratchet mechanism</i>
13-02-497	1 x Zerlegbarer Rahmen, mittel <i>segmented ring, medium</i>
13-02-944	1 x Valve biegsam, flach, 38 x 152 mm <i>blade malleable, flat, 38 x 152 mm</i>
13-02-947	1 x Valve biegsam, flach, 76 x 152 mm <i>blade malleable, flat, 76 x 152 mm</i>
13-02-526	1 x KELLY Valve 51 x 127 mm <i>KELLY blade 51 x 127 mm</i>
13-02-527	1 x KELLY Valve 51 x 152 mm <i>KELLY blade 51 x 152 mm</i>
13-02-488	1 x Horizontale Wendestange, 360° drehbar <i>horizontal flex bar, 360° rotation</i>
13-02-831	1 x HARRINGTON Valve 63 x 143 mm <i>HARRINGTON blade 63 x 143 mm</i>
13-02-546	1 x GELPI Valve mit Spitze <i>GELPI point blade</i>



	Artikel-Nr. Cat. No.	
	13-52-669	Ring Retraktor Tischarretierung 300 mm, 12" <i>ring retractor table post</i> 300 mm, 12"
	13-02-487	Ring Retraktor, horizontale Stange <i>ring retractor, horizontal bar</i>
	13-02-488	Horizontale Wendestange, 360° drehbar <i>horizontal flex bar, 360° rotation</i>
	13-02-504	Arretierkupplung ø 25 mm, 1" <i>post coupling ø 25 mm, 1"</i>
	13-02-503	Rastmechanismus, standard <i>ratchet mechanism, standard</i>
	13-02-510	Rastmechanismus, kippbar <i>tilt ratchet mechanism</i>
	13-02-516	Rahmen oval, mittel <i>ring oval, medium</i>
	13-02-497	Zerlegbarer Rahmen, mittel <i>segmented ring, medium</i>

Artikel-Nr.
Cat. No.

13-02-944	Valve biegsam, flach, 38 x 152 mm <i>blade malleable, flat, 38 x 152 mm</i>		
13-02-946	Valve biegsam, flach, 51 x 152 mm <i>blade malleable, flat, 51 x 152 mm</i>		
13-02-947	Valve biegsam, flach, 76 x 152 mm <i>blade malleable, flat, 76 x 152 mm</i>		
13-02-524	Valve 51 x 76 mm <i>blade 51 x 76 mm</i>	KELLY	
13-02-525	Valve 51 x 101 mm <i>blade 51 x 101 mm</i>		
13-02-526	Valve 51 x 127 mm <i>blade 51 x 127 mm</i>		
13-02-527	Valve 51 x 152 mm <i>blade 51 x 152 mm</i>		
13-02-546	Valve mit Spitze <i>point blade</i>	GELPI	
13-02-534	Valve schmal <i>blade narrow</i>	BALFOUR	
13-02-831	Valve 63 x 143 mm <i>blade 63 x 143 mm</i>	HARRINGTON	

Artikel-Nr.
Cat. No.

 1/2
CASPAR
02-22-450

CASPAR

02-22-450

Laminektomie-Sperrer, lumbal, thorakal, zervikal, Spreizweite 150 mm, komplett, bestehend aus: Laminectomy Retractor, lumbal, thoracal, cervical, spread 150 mm, complete, consisting of:

- 02-22-449** 1x Sperrer allein, mit Drehschlüssel 20-55-749 retractor only, with key 20-55-749
- 02-22-435** 1x Haken 38 mm hook 38 mm
- 02-22-442** 1x Valve 22 x 37 mm blade 22 x 37 mm
- 02-22-443** 1x Valve 22 x 43 mm blade 22 x 43 mm
- 02-22-444** 1x Valve 22 x 47 mm blade 22 x 47 mm
- 02-22-445** 1x Valve 22 x 52 mm blade 22 x 52 mm
- 02-22-446** 1x Valve 22 x 57 mm blade 22 x 57 mm

Artikel-Nr.
Cat. No.

 1/2
20-55-749

20-55-749

Schlüssel für Sperrer 02-22-449
 key for retractor 02-22-449

Artikel-Nr.
Cat. No.

 1/2
CASPAR
02-22-435
 38 mm

CASPAR

02-22-435

Haken 38 mm
 hook 38 mm



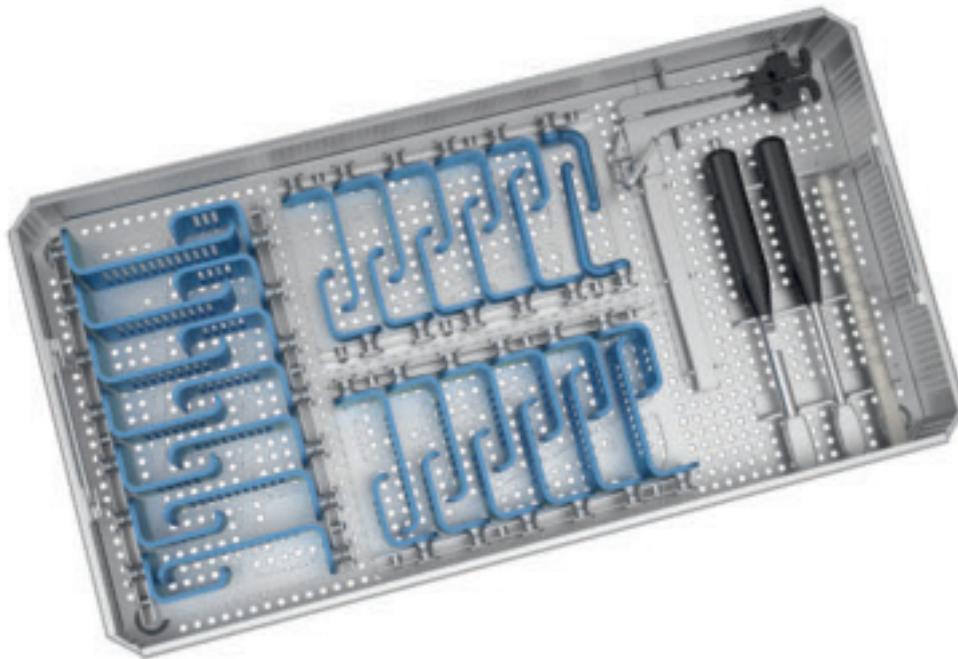

02-22-437

Haken 58 mm
 hook 58 mm

Artikel-Nr. Cat. No.	Maße B x L Measurements W x L		
02-22-441	Valve 22 x 32 mm blade 22 x 32 mm	CASPAR	 <p>1/2 CASPAR 02-22-445 22 x 52 mm</p>
02-22-442	Valve 22 x 37 mm blade 22 x 37 mm		
02-22-443	Valve 22 x 42 mm blade 22 x 42 mm		
02-22-444	Valve 22 x 47 mm blade 22 x 47 mm		
02-22-445	Valve 22 x 52 mm blade 22 x 52 mm		
02-22-446	Valve 22 x 57 mm blade 22 x 57 mm		
02-22-447	Valve 22 x 62 mm blade 22 x 62 mm		
02-22-448	Valve 22 x 67 mm blade 22 x 67 mm		
02-22-451	Valve 37 x 32 mm blade 37 x 32 mm	CASPAR	 <p>1/2 CASPAR 02-22-456 37 x 57 mm</p>
02-22-452	Valve 37 x 37 mm blade 37 x 37 mm		
02-22-453	Valve 37 x 42 mm blade 37 x 42 mm		
02-22-454	Valve 37 x 47 mm blade 37 x 47 mm		
02-22-455	Valve 37 x 52 mm blade 37 x 52 mm		
02-22-456	Valve 37 x 57 mm blade 37 x 57 mm		
02-22-457	Valve 37 x 62 mm blade 37 x 62 mm		
02-22-458	Valve 37 x 67 mm blade 37 x 67 mm		
02-22-461	Valve 52 x 32 mm blade 52 x 32 mm	CASPAR	 <p>1/2 CASPAR 02-22-467 52 x 62 mm</p>
02-22-462	Valve 52 x 37 mm blade 52 x 37 mm		
02-22-463	Valve 52 x 42 mm blade 52 x 42 mm		
02-22-464	Valve 52 x 47 mm blade 52 x 47 mm		
02-22-465	Valve 52 x 52 mm blade 52 x 52 mm		
02-22-466	Valve 52 x 57 mm blade 52 x 57 mm		
02-22-467	Valve 52 x 62 mm blade 52 x 62 mm		
02-22-468	Valve 52 x 67 mm blade 52 x 67 mm		

Artikel-Nr.
Cat. No.

02-23-120	CLR Set Side-load, bestehend aus: <i>CLR Set Side load, consisting of:</i>	
02-23-121	1 x	CLR Siebkorb, Edelstahl mit Deckel, 485 x 253 x 70 mm <i>CLR Tray, stainless steel with cover, 485 x 253 x 70 mm</i>
02-23-001	1 x	CLR Retraktor Side-load <i>CLR retractor side-load</i>
02-73-050	1 x	CLR Handgriff Side-load <i>CCR handle side-load for blades</i>
02-73-051	1 x	CLR Handgriff Side-load, kanuliert mit Luer-Lock <i>CCR handle side-load for blades, cannulated with Luer-Lock</i>
02-23-011	1 x	CLR Tiefenmeßstab <i>CLR depth gauge</i>
02-23-020T	2 x	CLR Valve 20 x 35 mm <i>CLR blade 20 x 35 mm</i>
02-23-021T	2 x	CLR Valve 20 x 40 mm <i>CLR blade 20 x 40 mm</i>
02-23-022T	2 x	CLR Valve 20 x 45 mm <i>CLR blade 20 x 45 mm</i>
02-23-023T	2 x	CLR Valve 20 x 55 mm <i>CLR blade 20 x 55 mm</i>
02-23-024T	2 x	CLR Valve 20 x 65 mm <i>CLR blade 20 x 65 mm</i>
02-23-030T	2 x	CLR Valve 40 x 35 mm <i>CLR blade 40 x 35 mm</i>
02-23-031T	2 x	CLR Valve 40 x 40 mm <i>CLR blade 40 x 40 mm</i>
02-23-032T	2 x	CLR Valve 40 x 45 mm <i>CLR blade 40 x 45 mm</i>
02-23-033T	2 x	CLR Valve 40 x 55 mm <i>CLR blade 40 x 55 mm</i>
02-23-034T	2 x	CLR Valve 40 x 65 mm <i>CLR blade 40 x 65 mm</i>
02-23-035T	2 x	CLR Valve 40 x 75 mm <i>CLR blade 40 x 75 mm</i>
02-23-040T	2 x	CLR Valve 60 x 35 mm <i>CLR blade 60 x 35 mm</i>
02-23-041T	2 x	CLR Valve 60 x 40 mm <i>CLR blade 60 x 40 mm</i>
02-23-042T	2 x	CLR Valve 60 x 45 mm <i>CLR blade 60 x 45 mm</i>
02-23-043T	2 x	CLR Valve 60 x 55 mm <i>CLR blade 60 x 55 mm</i>
02-23-044T	2 x	CLR Valve 60 x 65 mm <i>CLR blade 60 x 65 mm</i>
02-23-045T	2 x	CLR Valve 60 x 75 mm <i>CLR blade 60 x 75 mm</i>
02-23-046T	2 x	CLR Valve 60 x 85 mm <i>CLR blade 60 x 85 mm</i>
02-23-028T	1 x	Hemi-Laminektomie Haken, klein, 50 mm <i>hemilaminectomy hook, small, 50 mm</i>
02-23-038T	1 x	Hemi-Laminektomie Haken, groß, 70 mm <i>hemi-laminectomy hook, large, 70 mm</i>

Artikel-Nr. Cat. No.			 <p data-bbox="1340 761 1444 817">CASPAR 02-23-001</p>
02-23-001	CLR Retraktor Side-load <i>CLR retractor side-load</i>	CASPAR	 <p data-bbox="1340 761 1444 817">CASPAR 02-23-001</p>
02-73-050	CLR Handgriff Side-load <i>CCR handle side-load for blades</i>		 <p data-bbox="1340 1064 1444 1097">02-23-050</p>
02-73-051	CLR Handgriff Side-loaded, kanuliert mit Luer-Lock <i>CCR handle side-load for blades, cannulated with Luer-Lock</i>		 <p data-bbox="1340 1332 1444 1366">02-23-051</p>
02-23-011	CLR Tiefenmessstab <i>CLR depth gauge</i>		 <p data-bbox="1340 1590 1444 1624">02-23-011</p>

 1/2
02-23-024T
 20 x 55 mm

 1/2
02-23-034T
 40 x 55 mm

 1/2
02-23-046T
 60 x 85 mm

 1/2
02-23-028T
 50 mm

TITAN Valve für mono-segmentalen Zugang, semi-röntgentransparent
TITANIUM Blade for mono-segmental access, semi x-ray transparent
TITAN

Artikel-Nr. Cat. No.	Maße B x L Measurements W x L
02-23-020T	20 x 35 mm
02-23-021T	20 x 40 mm
02-23-022T	20 x 45 mm
02-23-023T	20 x 50 mm
02-23-024T	20 x 55 mm

TITAN Valve für bi-segmentalen Zugang, semi-röntgentransparent
TITANIUM Blade for bi-segmental access, semi x-ray transparent
TITAN

Artikel-Nr. Cat. No.	Maße B x L Measurements W x L
02-23-030T	40 x 35 mm
02-23-031T	40 x 40 mm
02-23-032T	40 x 45 mm
02-23-033T	40 x 55 mm
02-23-034T	40 x 65 mm
02-23-035T	40 x 75 mm

TITAN Valve für multi-segmentalen Zugang, semi-röntgentransparent
TITANIUM Blade for multi-segmental access, semi x-ray transparent
TITAN

Artikel-Nr. Cat. No.	Maße B x L Measurements W x L
02-23-040T	60 x 35 mm
02-23-041T	60 x 40 mm
02-23-042T	60 x 45 mm
02-23-043T	60 x 55 mm
02-23-044T	60 x 65 mm
02-23-045T	60 x 75 mm
02-23-046T	60 x 85 mm

TITAN

Artikel-Nr. Cat. No.	Länge Length
02-23-028T	50 mm CLR Hemi-Laminektomiehooken, klein, semi-röntgentransparent, TITAN CLR hemi-laminectomy hook, small, semi x-ray transparent, TITANIUM
02-23-038T	70 mm CLR Hemi-Laminektomiehooken, groß, semi-röntgentransparent, TITAN CLR hemi-laminectomy hook, large, semi x-ray transparent, TITANIUM

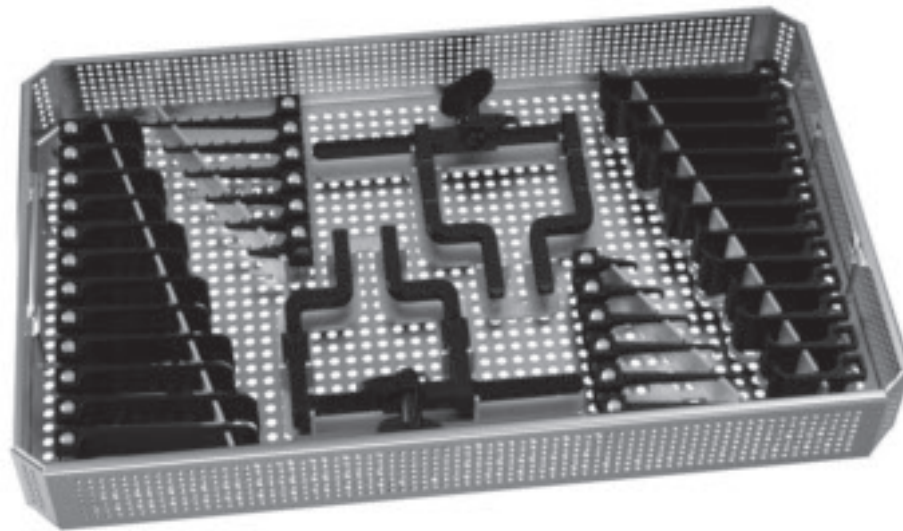

Artikel-Nr.
Cat. No.

02-72-667

MC CULLOCH Retraktor Set groß, bestehend aus:
MC CULLOCH Retractor Set large, consisting of:

- | | | | |
|------------------|---|------------------|---|
| 02-72-668 | 1 x Siebkorb für MC CULLOCH Set groß, 405 x 253 x 50 mm
<i>basket for MC CULLOCH set large, 405 x 253 x 50 mm</i> | 02-72-684 | 2 x Breite Muskelvalve 27 x 80 mm
<i>wide muscle blade 27 x 80 mm</i> |
| 02-72-670 | 2 x MC CULLOCH Retraktor mit Gelenken
<i>MC CULLOCH retractor with hinge</i> | 02-72-686 | 1 x Haken 1,8 x 20 mm
<i>hook 1.8 x 20 mm</i> |
| 02-72-672 | 2 x Schmale Muskelvalve 20 x 30 mm
<i>narrow muscle blade 20 x 30 mm</i> | 02-72-687 | 1 x Haken 1,8 x 30 mm
<i>hook 1.8 x 30 mm</i> |
| 02-72-673 | 2 x Schmale Muskelvalve 20 x 40 mm
<i>narrow muscle blade 20 x 40 mm</i> | 02-72-688 | 1 x Haken 1,8 x 40 mm
<i>hook 1.8 x 40 mm</i> |
| 02-72-674 | 2 x Schmale Muskelvalve 20 x 50 mm
<i>narrow muscle blade 20 x 50 mm</i> | 02-72-689 | 1 x Haken 1,8 x 50 mm
<i>hook 1.8 x 50 mm</i> |
| 02-72-675 | 2 x Schmale Muskelvalve 20 x 60 mm
<i>narrow muscle blade 20 x 60 mm</i> | 02-72-690 | 1 x Haken 1,8 x 60 mm
<i>hook 1.8 x 60 mm</i> |
| 02-72-676 | 2 x Schmale Muskelvalve 20 x 70 mm
<i>narrow muscle blade 20 x 70 mm</i> | 02-72-691 | 1 x Haken 1,8 x 70 mm
<i>hook 1.8 x 70 mm</i> |
| 02-72-677 | 2 x Schmale Muskelvalve 20 x 80 mm
<i>narrow muscle blade 20 x 80 mm</i> | 02-72-693 | 1 x Mehrzahn-Haken 2 x 20 mm
<i>multiple toothed hook 2 x 20 mm</i> |
| 02-72-679 | 2 x Breite Muskelvalve 27 x 30 mm
<i>wide muscle blade 27 x 30 mm</i> | 02-72-694 | 1 x Mehrzahn-Haken 2 x 30 mm
<i>multiple toothed hook 2 x 30 mm</i> |
| 02-72-680 | 2 x Breite Muskelvalve 27 x 40 mm
<i>wide muscle blade 27 x 40 mm</i> | 02-72-695 | 1 x Mehrzahn-Haken 2 x 40 mm
<i>multiple toothed hook 2 x 40 mm</i> |
| 02-72-681 | 2 x Breite Muskelvalve 27 x 50 mm
<i>wide muscle blade 27 x 50 mm</i> | 02-72-696 | 1 x Mehrzahn-Haken 2 x 50 mm
<i>multiple toothed hook 2 x 50 mm</i> |
| 02-72-682 | 2 x Breite Muskelvalve 27 x 60 mm
<i>wide muscle blade 27 x 60 mm</i> | 02-72-697 | 1 x Mehrzahn-Haken 2 x 60 mm
<i>multiple toothed hook 2 x 60 mm</i> |
| 02-72-683 | 2 x Breite Muskelvalve 27 x 70 mm
<i>wide muscle blade 27 x 70 mm</i> | 02-72-698 | 1 x Mehrzahn-Haken 2 x 70 mm
<i>multiple toothed hook 2 x 70 mm</i> |



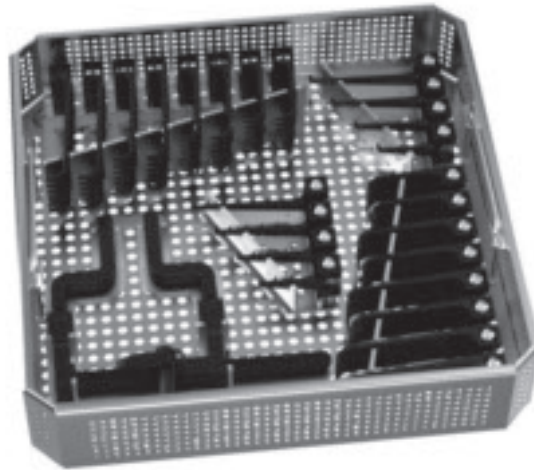

Artikel-Nr.
Cat. No.

02-72-665	MC CULLOCH Retraktor Set klein, bestehend aus: <i>MC CULLOCH Retractor Set small ,consisting of:</i>		
02-72-666	1 x Siebkorb für MC CULLOCH Set klein, 243 x 253 x 50 mm <i>basket for MC CULLOCH set small, 243 x 253 x 50 mm</i>		02-72-687 1 x Haken 1,8 x 30 mm <i>hook 1.8 x 30 mm</i>
02-72-670	1 x MC CULLOCH Retraktor mit Gelenken <i>MC CULLOCH retractor with hinge</i>		02-72-688 1 x Haken 1,8 x 40 mm <i>hook 1.8 x 40 mm</i>
02-72-673	2 x Schmale Muskelvalve 20 x 40 mm <i>narrow muscle blade 20 x 40 mm</i>		02-72-689 1 x Haken 1,8 x 50 mm <i>hook 1.8 x 50 mm</i>
02-72-674	2 x Schmale Muskelvalve 20 x 50 mm <i>narrow muscle blade 20 x 50 mm</i>		02-72-690 1 x Haken 1,8 x 60 mm <i>hook 1.8 x 60 mm</i>
02-72-675	2 x Schmale Muskelvalve 20 x 60 mm <i>narrow muscle blade 20 x 60 mm</i>		02-72-694 1 x Mehrzahn-Haken 2 x 30 mm <i>multiple toothed hook 2 x 30 mm</i>
02-72-676	2 x Schmale Muskelvalve 20 x 70 mm <i>narrow muscle blade 20 x 70 mm</i>		02-72-695 1 x Mehrzahn-Haken 2 x 40 mm <i>multiple toothed hook 2 x 40 mm</i>
02-72-680	2 x Breite Muskelvalve 27 x 40 mm <i>wide muscle blade 27 x 40 mm</i>		02-72-696 1 x Mehrzahn-Haken 2 x 50 mm <i>multiple toothed hook 2 x 50 mm</i>
02-72-681	2 x Breite Muskelvalve 27 x 50 mm <i>wide muscle blade 27 x 50 mm</i>		02-72-697 1 x Mehrzahn-Haken 2 x 60 mm <i>multiple toothed hook 2 x 60 mm</i>
02-72-682	2 x Breite Muskelvalve 27 x 60 mm <i>wide muscle blade 27 x 60 mm</i>		
02-72-683	2 x Breite Muskelvalve 27 x 70 mm <i>wide muscle blade 27 x 70 mm</i>		

Artikel-Nr.
Cat. No.

02-72-670

Retraktor mit Gelenk,
max. Spreizweite 85 mm,
schwarz, titanbeschichtet

*retractor with hinge,
max. spread 85 mm,
black, titanium-coated*

MC CULLOCH

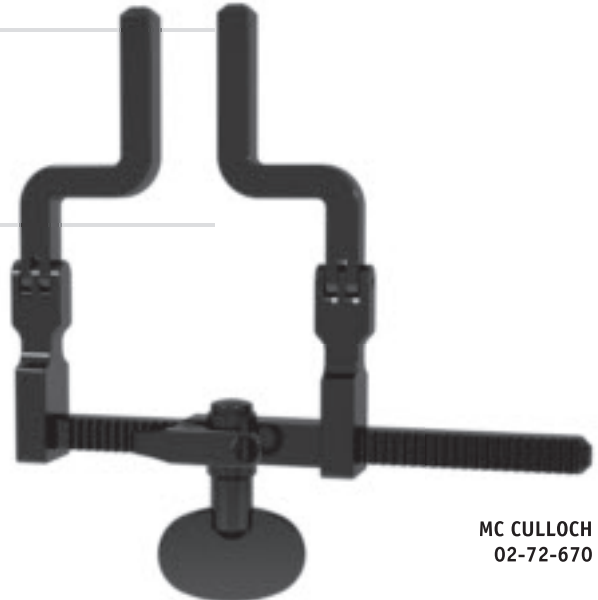

MC CULLOCH
02-72-670

Artikel-Nr.
Cat. No.

02-72-671

Retraktor mit starren Armen,
max. Spreizweite 85 mm,
schwarz, titanbeschichtet

*retractor with rigid arms,
max. spread 85 mm,
black, titanium-coated*

MC CULLOCH



MC CULLOCH
02-72-671



	Artikel-Nr. Cat. No.	Maße B x L Measurements W x L
MC CULLOCH	02-72-672	20 x 30 mm
	02-72-673	20 x 40 mm
	02-72-674	20 x 50 mm
	02-72-675	20 x 60 mm
	02-72-676	20 x 70 mm
	02-72-677	20 x 80 mm
	02-72-678	20 x 90 mm
		Schmale Muskelvalve, schwarz, titanbeschichtet <i>narrow muscle blade, black, titanium-coated</i>



MC CULLOCH	02-72-679	27 x 30 mm
	02-72-680	27 x 40 mm
	02-72-681	27 x 50 mm
	02-72-682	27 x 60 mm
	02-72-683	27 x 70 mm
	02-72-684	27 x 80 mm
	02-72-685	27 x 90 mm
		Breite Muskelvalve, schwarz, titanbeschichtet <i>wide muscle blade, black, titanium-coated</i>



MC CULLOCH	02-72-686	1,8 x 20 mm
	02-72-687	1,8 x 30 mm
	02-72-688	1,8 x 40 mm
	02-72-689	1,8 x 50 mm
	02-72-690	1,8 x 60 mm
	02-72-691	1,8 x 70 mm
	02-72-692	1,8 x 80 mm
		Haken, schwarz, titanbeschichtet <i>hook, black, titanium-coated</i>





MC CULLOCH	02-72-693	2 x 20 mm
	02-72-694	2 x 30 mm
	02-72-695	2 x 40 mm
	02-72-696	2 x 50 mm
	02-72-697	2 x 60 mm
	02-72-698	2 x 70 mm
	02-72-699	2 x 80 mm
		Mehrzahn-Haken, schwarz, titanbeschichtet <i>multiple toothed hook, black, titanium-coated</i>

Artikel-Nr. Cat. No.	Maße B x L Measurements W x L		
02-72-710	40 x 27 mm Konische Muskelvalve, schwarz, titanbeschichtet <i>tapered muscle blade, black, titanium-coated</i>	MC CULLOCH	
02-72-700	17 x 30 mm	MC CULLOCH	
02-72-701	17 x 40 mm		
02-72-702	17 x 50 mm		
02-72-703	17 x 60 mm		
02-72-704	17 x 70 mm		
02-72-705	17 x 80 mm		
02-72-706	17 x 90 mm Kleine Muskelvalve, 2 Zähne, schwarz, titanbeschichtet <i>small muscle blade, 2 teeth, black, titanium-coated</i>		
02-72-707	20 x 50 mm	MC CULLOCH	
02-72-708	20 x 60 mm		
02-72-709	20 x 70 mm Kleine Muskelvalve, 2 Zähne, schwarz, titanbeschichtet <i>small muscle blade, 2 teeth, black, titanium-coated</i>		







1/1
ALM
02-22-010
70 mm
2¾"

		Artikel-Nr. Cat. No.	Gesamtlänge Total length
	1/1	ALM 02-22-010	70 mm / 2¾"
		02-72-010	100 mm / 4"
			spitz sharp
	1/1	ALM 02-72-011	70 mm / 2¾"
		02-22-011	100 mm / 4"
			stumpf blunt



1/1
JANSEN
02-22-030
100 mm
4"

		Artikel-Nr. Cat. No.	Gesamtlänge Total length
	1/1	JANSEN 02-22-030	100 mm / 4"
			scharf sharp
	1/1	JANSEN 02-22-032	100 mm / 4"
		02-72-032	110 mm / 4¾"
			stumpf blunt

Artikel-Nr. Cat. No.	Gesamtlänge Total length		
02-72-996	130 mm / 5 1/8"	GELPI	1/1
02-22-997	175 mm / 7"		
Hautspreizer, scharf skin retractor, sharp			



1/2
GELPI
02-22-997
175 mm
7"

Artikel-Nr. Cat. No.	Gesamtlänge Total length		
02-22-993	185 mm / 7 3/4"	JACKSON- BURROWS	
	Hautspreizer, stumpf skin retractor, blunt		



1/2
JACKSON-BURROWS
02-22-993
185 mm
7 3/4"



1/2
PLESTER
02-22-090
 110 mm
 4³/₈"

		Artikel-Nr. Cat. No.	Gesamtlänge Total length
	PLESTER	02-22-090	110 mm / 4 ³ / ₈ " stumpf, volles Blatt links <i>blunt, solid blade left</i>
	PLESTER	02-22-091	110 mm / 4 ³ / ₈ " stumpf, volles Blatt rechts <i>blunt, solid blade right</i>



7



1/2
PLESTER
02-22-078
 130 mm
 5¹/₈"

		Artikel-Nr. Cat. No.	Gesamtlänge Total length
	PLESTER	02-22-078	130 mm / 5 ¹ / ₈ " scharf <i>sharp</i>
	PLESTER	02-22-079	130 mm / 5 ¹ / ₈ " stumpf <i>blunt</i>

Artikel-Nr. Cat. No.	Gesamtlänge Total length		
15-11-794	130 mm / 5 1/8" scharf, volles Blatt rechts <i>sharp, solid blade right</i>	PERKINS	
15-11-795	130 mm / 5 1/8" scharf, volles Blatt links <i>sharp, solid blade left</i>	PERKINS	





1/2
PERKINS
15-11-795
130 mm
5 1/8"

Artikel-Nr. Cat. No.	Gesamtlänge Total length		
02-22-076	130 mm / 5 1/8" scharf <i>sharp</i>	WULLSTEIN	
02-22-077	130 mm / 5 1/8" stumpf <i>blunt</i>	WULLSTEIN	



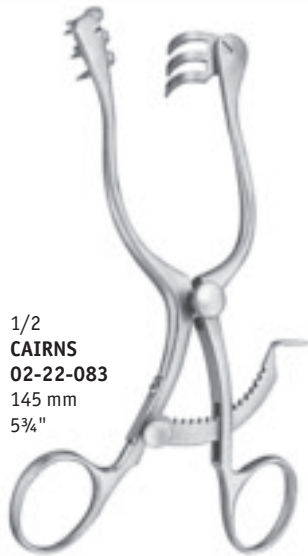

1/2
WULLSTEIN
02-22-077
130 mm
5 1/8"

 1/2
CAIRNS
 02-22-083
 145 mm
 5¾"



		Artikel-Nr. Cat. No.	Gesamtlänge Total length
1/1	CAIRNS	02-22-083	145 mm / 5¾"
			scharf <i>sharp</i>
1/1	CAIRNS	02-72-081	145 mm / 5¾"
			stumpf <i>blunt</i>

 1/2
ADSON-BABY
 02-72-085
 160 mm
 6¼"

		Artikel-Nr. Cat. No.	Gesamtlänge Total length
1/1	ADSON-BABY	02-22-085	145 mm / 5¾"
		02-72-085	160 mm / 6¼"
1/1	ADSON-BABY	02-72-086	145 mm / 5¾"
		02-72-087	160 mm / 6¼"
			stumpf <i>blunt</i>



 1/2
JEFFERSON
 02-22-092
 140 mm
 5½"

		Artikel-Nr. Cat. No.	Gesamtlänge Total length
1/1	JEFFERSON	02-22-092	140 mm / 5½"
			stumpf, gebogen <i>blunt, curved</i>

Artikel-Nr. Cat. No.	Gesamtlänge Total length		
02-22-093	130 mm / 5½"	MOLLISON	1/1
	2 x 2 Zähne, scharf 2 x 2 teeth, sharp		
02-22-088	155 mm / 6"	MOLLISON	1/1
	4 x 4 Zähne, scharf 4 x 4 teeth, sharp		



1/2
MOLLISON
02-22-088
155 mm
6"

Artikel-Nr. Cat. No.	Gesamtlänge Total length		
02-72-090	140 mm / 5½"	CONTOUR	1/1
	Kopfhautspreizer, scharf scalp retractor, sharp		
02-72-091	140 mm / 5½"	CONTOUR	1/1
	Kopfhautspreizer, stumpf scalp retractor, blunt		



1/2
CONTOUR
02-72-090
140 mm
5½"

 1/2
WEITLANER
02-22-068
 165 mm
 6½"

		Artikel-Nr. Cat. No.	Gesamtlänge Total length
1/1		WEITLANER 02-22-101	130 mm / 5¼"
		02-22-072	165 mm / 6½" scharf <i>sharp</i>
		WEITLANER 02-22-068	165 mm / 6½" halbscharf <i>semi sharp</i>
1/1		WEITLANER 02-22-104	130 mm / 5¼"
		02-22-075	165 mm / 6½" stumpf <i>blunt</i>

 1/2
WEITLANER
02-22-206
 240 mm
 9½"

		Artikel-Nr. Cat. No.	Gesamtlänge Total length
1/1		WEITLANER 02-22-200	195 mm / 7¾" 3 x 4 Zähne, scharf <i>3 x 4 teeth, sharp</i>
		02-22-206	240 mm / 9½" 3 x 4 Zähne, scharf <i>3 x 4 teeth, sharp</i>
		02-22-208	255 mm / 10" 5 x 6 Zähne, scharf <i>5 x 6 teeth, sharp</i>
1/1		WEITLANER 02-22-201	195 mm / 7¾" 3 x 4 Zähne, stumpf <i>3 x 4 teeth, blunt</i>
		02-22-207	240 mm / 9½" 3 x 4 Zähne, stumpf <i>3 x 4 teeth, blunt</i>
		02-22-209	255 mm / 10" 5 x 6 Zähne, stumpf <i>5 x 6 teeth, blunt</i>

Artikel-Nr. Cat. No.	Gesamtlänge Total length		
02-72-220	140 mm / 5½"	scharf sharp	WEITLANER- BECKMANN
02-72-221	170 mm / 6¾"		
02-72-222	220 mm / 8¾"		
02-72-223	140 mm / 5½"	stumpf blunt	WEITLANER- BECKMANN
02-72-224	170 mm / 6¾"		
02-72-225	220 mm / 8¾"		



1/2
WEITLANER-
BECKMANN
02-72-221
170 mm
6¾"

Artikel-Nr. Cat. No.	Gesamtlänge Total length		
02-72-226	310 mm / 12"	scharf sharp	BECKMANN



1/3
BECKMANN
02-72-226
310 mm
12"



1/2
MAYO-ADAMS
02-22-112
 165 mm
 6½"

		Artikel-Nr. Cat. No.	Gesamtlänge Total length
	MAYO-ADAMS	02-22-112	165 mm / 6½"



1/2
HENDERSON
02-22-113
 180 mm
 7"

		Artikel-Nr. Cat. No.	Gesamtlänge Total length
	HENDERSON	02-22-113	180 mm / 7" scharf sharp

Artikel-Nr. Cat. No.		Gesamtlänge Total length		
02-72-210	scharf <i>sharp</i>	220 mm / 8¾"	MISKIMON	1/1
02-72-211	stumpf <i>blunt</i>	220 mm / 8¾"	MISKIMON	1/1



1/2
MISKIMON
02-72-210
220 mm
8¾"

Artikel-Nr. Cat. No.		Gesamtlänge Total length		
02-22-250	scharf <i>sharp</i>	190 mm / 7¼"	ANDERSON- ADSON	1/1
02-72-249	stumpf <i>blunt</i>	190 mm / 7¼"	ANDERSON- ADSON	1/1



1/2
ANDERSON-ADSON
02-22-250
190 mm
7¼"

 Artikel-Nr.
 Cat. No.

CLOWARD

02-22-380

Wundspreizer, komplett, bestehend aus:
Self-Retaining Retractor, complete, consisting of:

- | | |
|------------------|--|
| 02-22-379 | 1x Sperrer, allein, 250 mm, 10"
<i>spreader only, 250 mm, 10"</i> |
| 02-22-381 | 1x Valve, 40 mm
<i>blade, 40 mm</i> |
| 02-22-382 | 1x Valve, 45 mm
<i>blade, 45 mm</i> |
| 02-22-383 | 1x Valve, 50 mm
<i>blade, 50 mm</i> |
| 02-22-384 | 1x Valve, 55 mm
<i>blade, 55 mm</i> |
| 02-22-385 | 1x Valve, 60 mm
<i>blade, 60 mm</i> |

 1/2
CLOWARD
02-22-380
 250 mm
 10"

 Artikel-Nr.
 Cat. No.

CLOWARD

02-72-390

Wundspreizer, komplett, bestehend aus:
Self-Retaining Retractor, complete, consisting of:

- | | |
|------------------|--|
| 02-72-389 | 1x Sperrer, allein, 150 mm, 6"
<i>spreader only, 150 mm, 6"</i> |
| 02-22-391 | 1x Valve, 40 mm
<i>blade, 40 mm</i> |
| 02-22-392 | 1x Valve, 45 mm
<i>blade, 45 mm</i> |
| 02-22-393 | 1x Valve, 50 mm
<i>blade, 50 mm</i> |
| 02-22-394 | 1x Valve, 55 mm
<i>blade, 55 mm</i> |
| 02-22-395 | 1x Valve, 60 mm
<i>blade, 60 mm</i> |

 1/2
CLOWARD
02-72-390
 130 mm
 5 1/8"

Artikel-Nr. Cat. No.	Blattlänge Length of blades		
02-22-381	40 mm / 1½"	CLOWARD	
02-22-382	45 mm / 1¾"		
02-22-383	50 mm / 2"		
02-22-384	55 mm / 2⅛"		
02-22-385	60 mm / 2¼"		
Valven gezahnt, für CLOWARD-Spreizer 02-22-379 und 02-72-389 blades, teethed, for CLOWARD retractor 02-22-397 and 02-72-389			



2/3
02-22-383
50 mm
2"



Artikel-Nr. Cat. No.	Blattlänge Length of blades		
02-22-391	40 mm / 1½"	CLOWARD	
02-22-392	45 mm / 1¾"		
02-22-393	50 mm / 2"		
02-22-394	55 mm / 2⅛"		
02-22-395	60 mm / 2¼"		
Valven stumpf, für CLOWARD-Spreizer 02-22-379 und 02-72-389 blades, blunt, for CLOWARD retractor 02-22-397 and 02-72-389			



2/3
02-22-394
55 mm
2⅛"







	Artikel-Nr. Cat. No.	Gesamtlänge Total length
1/1 	02-22-254	280 mm / 11" scharf, langes Blatt rechts <i>sharp, long blade right</i>
1/1 	02-22-255	280 mm / 11" scharf, langes Blatt links <i>sharp, long blade left</i>

1/3
02-22-254
 280 mm
 11"

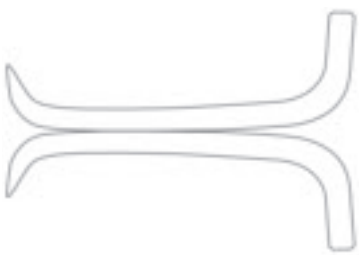



	Artikel-Nr. Cat. No.	Gesamtlänge Total length
1/1 	HARVEY JACKSON 02-22-258	280 mm / 11" scharf <i>sharp</i>

1/3
HARVEY JACKSON
02-22-258
 280 mm
 11"

Artikel-Nr. Cat. No.	Gesamtlänge Total length		
02-22-248	220 mm / 8¾"	NORFOLK AND NORWICH	1/2
	stumpf blunt		



1/2
NORFOLK
AND
NORWICH
02-22-248
220 mm
8¾"

Artikel-Nr. Cat. No.	Gesamtlänge Total length		
02-72-250	200 mm / 8"	ADSON	1/1
02-72-251	265 mm / 10½"		
	stumpf blunt		
02-72-252	200 mm / 8"	ADSON	1/1
02-22-252	265 mm / 10½"		
	scharf sharp		



1/2
ADSON
02-22-252
265 mm
10½"







		Artikel-Nr. Cat. No.	Gesamtlänge Total length
1/1	CONE	02-72-260	200 mm / 8"
		02-22-260	265 mm / 10½"
			scharf sharp
1/1	CONE	02-72-262	200 mm / 8"
		02-72-263	265 mm / 10½"
			stumpf blunt

1/3
CONE
02-22-260
 265 mm
 10½"



		Artikel-Nr. Cat. No.	Gesamtlänge Total length
1/1	ADSON	02-22-273	320 mm / 12½"
			halbscharf semi sharp

1/3
ADSON
02-22-273
 320 mm
 12½"

Artikel-Nr. Cat. No.	Gesamtlänge Total length		
02-22-271	310 mm / 12"	BECKMANN-ADSON	1/1
	halbscharf semi sharp		
02-22-272	310 mm / 12"	BECKMANN-ADSON	1/1
	scharf sharp		



1/3
BECKMANN-ADSON
02-22-272
310 mm
12"

Artikel-Nr. Cat. No.	Gesamtlänge Total length		
02-22-276	320 mm / 12 ³ / ₄ "	BECKMANN-EATON	1/2
	scharf sharp		



1/3
BECKMANN-EATON
02-22-276
320 mm
12³/₄"



1/2
WILLIAMS
02-72-310
 170 mm
 6¾"

	Artikel-Nr. Cat. No.	Gesamtlänge Total length
WILLIAMS	02-72-300	170 mm / 6¾"
		50 x 10 mm, gezahntes Blatt rechts 50 x 10 mm, serrated blade right
	02-72-310	170 mm / 6¾"
		50 x 10 mm, gezahntes Blatt links 50 x 10 mm, serrated blade left
	02-72-301	170 mm / 6¾"
		60 x 10 mm, gezahntes Blatt rechts 60 x 10 mm, serrated blade right
	02-72-311	170 mm / 6¾"
		60 x 10 mm, gezahntes Blatt links 60 x 10 mm, serrated blade left
	02-72-302	170 mm / 6¾"
		70 x 10 mm, gezahntes Blatt rechts 70 x 10 mm, serrated blade right
	02-72-312	170 mm / 6¾"
		70 x 10 mm, gezahntes Blatt links 70 x 10 mm, serrated blade left
	02-72-303	170 mm / 6¾"
		50 x 20 mm, gezahntes Blatt rechts 50 x 20 mm, serrated blade right
	02-72-313	170 mm / 6¾"
	50 x 20 mm, gezahntes Blatt links 50 x 20 mm, serrated blade left	
02-72-304	170 mm / 6¾"	
	60 x 20 mm, gezahntes Blatt rechts 60 x 20 mm, serrated blade right	
02-72-314	170 mm / 6¾"	
	60 x 20 mm, gezahntes Blatt links 60 x 20 mm, serrated blade left	
02-72-305	170 mm / 6¾"	
	70 x 20 mm, gezahntes Blatt rechts 70 x 20 mm, serrated blade right	
02-72-315	170 mm / 6¾"	
	70 x 20 mm, gezahntes Blatt links 70 x 20 mm, serrated blade left	

Artikel-Nr. Cat. No.	Gesamtlänge Total length	
02-72-283	190 mm / 7½"	MEYERDING
	Blätter gezahnt 32 x 25 mm <i>blades serrated 32 x 25 mm</i>	
02-72-280	190 mm / 7½"	
	Blätter gezahnt 45 x 25 mm <i>blades serrated 45 x 25 mm</i>	
02-72-281	190 mm / 7½"	
	Blätter gezahnt 55 x 25 mm <i>blades serrated 55 x 25 mm</i>	
02-72-284	190 mm / 7½"	
	Blätter gezahnt 60 x 19 mm <i>blades serrated 60 x 19 mm</i>	
02-72-282	190 mm / 7½"	
	Blätter gezahnt 60 x 25 mm <i>blades serrated 60 x 25 mm</i>	



1/2
MEYERDING
02-72-281
190 mm
7¼"

Artikel-Nr. Cat. No.	Gesamtlänge Total length	
02-72-285	180 mm / 7"	MARKHAM- MEYERDING
	45 x 25 mm, gezahntes Blatt rechts <i>45 x 25 mm, serrated blade right</i>	
02-72-299	180 mm / 7"	
	45 x 25 mm, gezahntes Blatt links <i>45 x 25 mm, serrated blade left</i>	
02-72-295	180 mm / 7"	
	55 x 25 mm, gezahntes Blatt rechts <i>55 x 25 mm, serrated blade right</i>	
02-72-296	180 mm / 7"	
	55 x 25 mm, gezahntes Blatt links <i>55 x 25 mm, serrated blade left</i>	



1/2
**MARKHAM-
MEYERDING**
02-72-285
180 mm
7"

 1/2
SCOVILLE
 02-72-520

**Artikel-Nr.
 Cat. No.**
SCOVILLE
02-72-520
**Laminektomie-Sperrer, komplett, bestehend aus:
 Laminectomy Retractor, complete consisting of:**
02-72-521 1x Spreizer, allein, Spreizweite 140 mm
retractor, only, spread 140 mm
02-72-525 1x Haken 50 mm
hook 50 mm
02-72-537 1x Valve 25 x 50 mm
blade 25 x 50 mm

 1/2
**SCOVILLE-
 HAVERFIELD**
 02-22-400

**Artikel-Nr.
 Cat. No.**
**SCOVILLE-
 HAVER-
 FIELD**
02-22-400
**Laminektomie-Sperrer mit Gelenkarmen, komplett, bestehend aus:
 Laminectomy Retractor, Arms with hinge, complete, consisting of:**
02-22-401 1x Spreizer, allein Spreizweite 140 mm
retractor, only, spread 140 mm
02-72-525 1x Haken 50 mm
hook 50 mm
02-72-537 1x Valve 25 x 50 mm
blade 25 x 50 mm

Artikel-Nr. Cat. No.	Maße Measurements
02-72-525	50 mm
02-72-526	70 mm
02-72-527	75 mm
	Haken, scharf, für Spreizer 02-22-401 und 02-72-521 <i>hook, sharp, for retractors 02-22-401 and 02-72-521</i>
02-22-403	50 mm
02-72-529	70 mm
02-72-530	75 mm
	Haken, stumpf, für Spreizer 02-22-401 und 02-72-521 <i>hook, blunt for retractors 02-22-401 and 02-72-521</i>
02-72-531	40 x 25 mm
02-72-532	40 x 40 mm
02-22-409	40 x 50 mm
	Valve, 3 Zähne, für Spreizer 02-22-401 und 02-72-521 <i>blade, 3 teeth, for retractors 02-22-401 and 02-72-521</i>
02-72-534	50 x 50 mm
02-22-411	50 x 60 mm
02-72-536	50 x 75 mm
	Valve, 4 Zähne, für Spreizer 02-22-401 und 02-72-521 <i>blade, 4 teeth, for retractors 02-22-401 and 02-72-521</i>
02-72-537	25 x 50 mm
02-22-405	25 x 60 mm
02-72-539	25 x 75 mm
	Valve für Spreizer 02-22-401 und 02-72-521 <i>blade for retractors 02-22-401 and 02-72-521</i>
02-72-540	50 x 50 mm
02-22-406	50 x 60 mm
02-72-542	50 x 75 mm
	Valve für Spreizer 02-22-401 und 02-72-521 <i>blade for retractors 02-22-401 and 02-72-521</i>



1/2
02-72-525
50 mm



1/2
02-72-534
50 x 50 mm

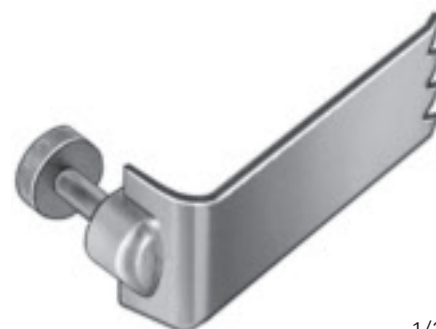

1/2
02-72-539
25 x 75 mm



 1/3
 SCOVILLE-RICHTER
 02-22-510

 Artikel-Nr.
 Cat. No.

 SCOVILLE-
 RICHTER

02-22-510

Laminektomie-Sperrer, Spreizweite 160 mm, komplett, bestehend aus:
Laminectomy Retractor, spread 160 mm, complete, consisting of:

 02-22-509 1x Sperrer, allein
spreader only

 02-22-516 1x Set Valven
set of blades

02-22-516

 Valven Set, bestehend aus:
set of blades, consisting of:

 1 Blatt 62 x 52 mm, 4 Zähne
1 blade 62 x 52 mm, 4 teeth

 1 Blatt 62 x 37 mm, 3 Zähne
1 blade 62 x 37 mm, 3 teeth

02-22-517

 Blatt 47 x 51 mm
blade 47 x 51 mm

02-22-518

 Blatt 30 x 40 mm
blade 30 x 40 mm

02-22-519

 Blatt 37 x 62 mm
blade 37 x 62 mm

Artikel-Nr. Cat. No.	Gesamtlänge Total length		
02-22-296	155 mm / 6" Blatt 5 mm, ohne Zähne blade 5 mm, without teeth	CLOWARD	
02-72-320	155 mm / 6" Blatt 5 mm, mit Zähnen blade 5 mm, with teeth	CLOWARD	



1/2
CLOWARD
02-22-320
 155 mm
 6"

Artikel-Nr. Cat. No.	Gesamtlänge Total length		
02-22-299	135 mm / 5¼" Blatt 4,5 mm, ohne Zähne blade 4.5 mm, without teeth	CLOWARD	
02-72-321	135 mm / 5¼" Blatt 4,5 mm, mit Zähnen blade 4.5 mm, with teeth	CLOWARD	



1/2
CLOWARD
02-22-299
 135 mm
 5¼"



1/2
INGE
02-72-297
 170 mm
 6¾"

	Artikel-Nr. <i>Cat. No.</i>	Gesamtlänge <i>Total length</i>
INGE	02-22-297	170 mm / 6¾" Blatt 6 mm, mit Zähnen <i>blade 6 mm, with teeth</i>
INGE	02-72-297	170 mm / 6¾" Blatt 6 mm, ohne Zähne <i>blade 6 mm, without teeth</i>



7



1/3
02-22-298
 250 mm
 10"

	Artikel-Nr. <i>Cat. No.</i>	Gesamtlänge <i>Total length</i>
INGE	02-72-298	250 mm / 10" Blatt 8 mm <i>blade 8 mm</i>
	02-22-298	250 mm / 10" Blatt 12 mm <i>blade 12 mm</i>

Area with horizontal lines for notes.



01

Mikro-Neurochirurgische Instrumente
Micro-Neurosurgical Instruments

02

HF-Instrumente und Zubehör
HF Instruments and Accessoires

03

Kopf-Schädelinstrumente und Haltesysteme
Head-Cranio Instruments and Holding Systems

04

Aneurysmen-Clip System
Aneurysm Clip System

05

Schädel-Verplattung
Cranial Plate System

06

Hypophysektomie-Instrumente
Pituitary Instruments

07

Instrumente für die Wirbelsäule, Wundspreizer
Spine Instruments, Self retaining Retractors

Laminektomie-Stanzen, Rongeure
Laminectomy Punches, Rongeurs

09

Gefäß- und Bulldogklemmen, Gefäß-Clips
Vessel- and Bulldog-Clamps, Vessel Clips

10

Allgemeinchirurgische Instrumente
General Surgical Instruments

11

Alphabetischer Index, Numerischer Index
Alphabetical Index, Numerical Index



SURGICAL
INSTRUMENTS
MICRO-NEURO-SPINE

/// 08

REBSTOCK®
Precision made in Germany

/// Laminektomie-Stanzen, Rongeurs
Laminectomy Punches, Rongeurs

/// www.rebstock.de

Die dünne Fußplatte für den Einsatz im zervikalen Bereich.

Thin footplate for the use in cervical surgeries.

Einfaches zerlegen per Knopf.

Quick and easy disassembling by pull button.

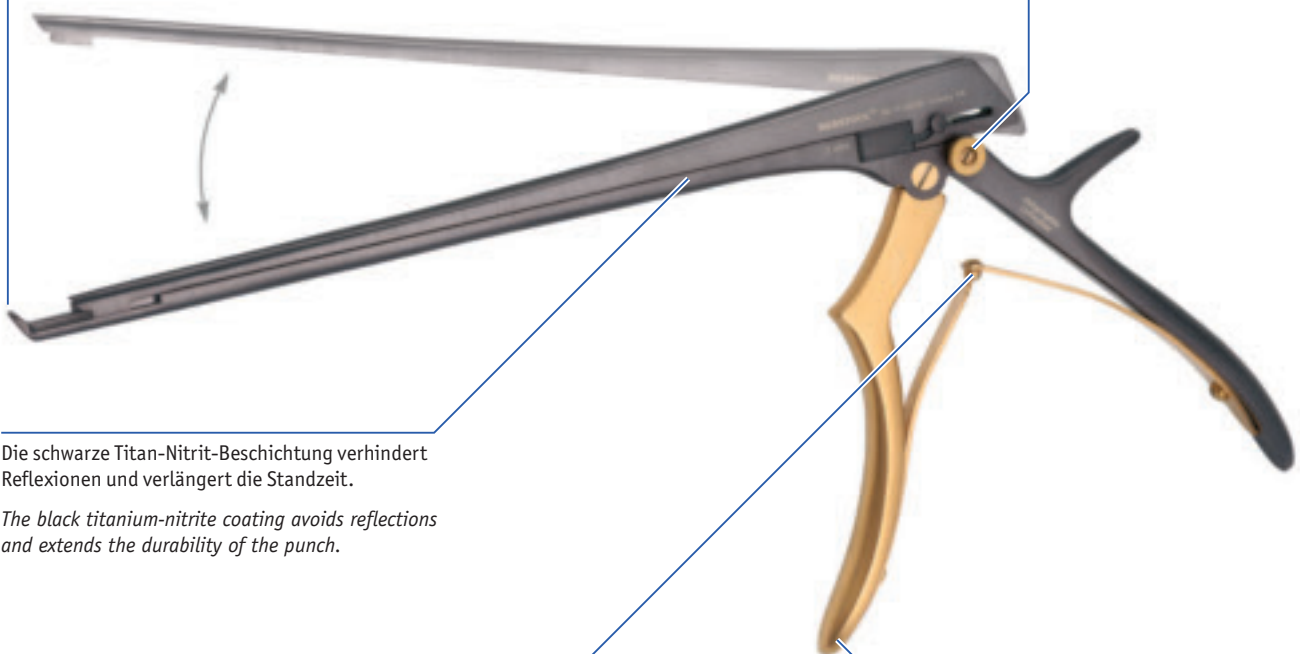

Die schwarze Titan-Nitrit-Beschichtung verhindert Reflexionen und verlängert die Standzeit.

The black titanium-nitrite coating avoids reflections and extends the durability of the punch.

Die goldene Feder definiert die Zerlegbarkeit der Stanze.

The golden spring stands for the detachability of the punch.

Der goldene Griff weist auf die dünne Fußplatte hin.

The golden handle refers to the thin footplate.

Der Auswerfer ist in die Führung integriert.



The ejector is integrated in the guiding.

Die präzise Führung reicht bis zum Schnitt.



The precise guiding extends to the cut.

Glatte Innenflächen an Haupt- und Schiebeteilen.



Smooth inner surfaces on main and sliding part.

Doppelte Markierung der Schnittbreite.



The cutting size is marked on the punch twice.

Die zerlegte Stanze bleibt als ein Teil zusammen.



The detached punch remains one part.

Die Stanze kann bei Bedarf auch in zwei Teile zerlegt werden.



The punch can also be disassembled in two parts.

Demontage Disassembly

Stanze schließen und Auslöseknopf ziehen.

Close the punch and pull the release button.



//01

Stanze öffnen und Schieber nach oben klappen. Die Stanze ist zerlegt. Alle Teile bleiben miteinander verbunden.

Open the punch and lift the sliding part up. The punch is disassembled. All parts remain connected with each other.

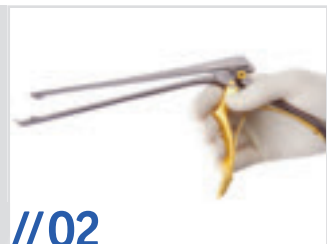

//02

Montage Assembly

Schieber in Führung am Hauptteil einsetzen.

Insert the sliding part in the guiding of the main part.



//01

Stanze schließen und gleichzeitig Schieber nach vorne bewegen. Die Stanze ist montiert und einsatzbereit.

Close the punch and push the sliding part to the front. The punch is assembled and ready for use.









//02

D E T A C H A B L E

 Alle Stanzen mit integriertem Auswerfer
 All punches with integrated ejector







 1/2
KERRISON
06-11-908
 180 mm
 7"

 Schaftlänge
 Length of shaft

		180 mm 7"	200 mm 8"	230 mm 9"	250 mm 10"	280 mm 11"	300 mm 12"
 1 mm, 130° (40°)	KERRISON	06-11-900	06-11-960	06-11-918	06-81-100	06-11-981	06-81-112
 2 mm, 130° (40°)		06-11-901	06-11-913	06-11-919	06-81-101	06-11-986	06-81-113
 3 mm, 130° (40°)		06-11-902	06-11-914	06-11-920	06-81-102	06-11-987	06-81-114
 4 mm, 130° (40°)		06-11-903	06-11-915	06-11-921	06-81-103	06-11-988	06-81-115
 5 mm, 130° (40°)		06-11-904	06-11-916	06-11-922	06-81-104	06-11-989	06-81-116
 6 mm, 130° (40°)		06-11-905	06-11-917	06-61-962	06-81-105	06-81-111	06-81-117

 mit dünner Fußplatte
 with thin footplate

 Schaftlänge
 Length of shaft

		180 mm 7"	200 mm 8"	230 mm 9"	250 mm 10"	280 mm 11"	300 mm 12"
 1 mm, 130° (40°)	KERRISON	06-11-906	06-11-961	06-11-929	06-81-121	06-11-980	06-81-129
 2 mm, 130° (40°)		06-11-907	06-11-962	06-11-925	06-81-122	06-11-976	06-81-130
 3 mm, 130° (40°)		06-11-908	06-11-963	06-11-926	06-81-123	06-11-977	06-81-131
 4 mm, 130° (40°)		06-11-909	06-11-964	06-11-927	06-81-124	06-11-978	06-81-132
 5 mm, 130° (40°)		06-11-910	06-11-965	06-11-928	06-81-125	06-11-979	06-81-133
 6 mm, 130° (40°)		06-61-947	06-61-948	06-61-949	06-81-126	06-81-128	06-81-134

Standard Line

 Oberfläche matt gebürstet
 Surface polished

 Beispiel-Artikel-Nr.
 Example Cat. No.

06-11-908
Black Line

 Oberfläche schwarz, titanbeschichtet
 Surface black, titanium-coated

 Beispiel-Artikel-Nr.
 Example Cat. No.

06-11-908B

D E T A C H A B L E



Alle Stanzen mit integriertem Auswerfer
All punches with integrated ejector

1/2
KERRISON
06-61-930B
200 mm
8"

Schaftlänge
Length of shaft

180 mm 7"	200 mm 8"	230 mm 9"	250 mm 10"	280 mm 11"	300 mm 12"		
06-11-948	06-61-921	06-61-933	06-81-135	06-81-141	06-81-147	KERRISON	1 mm, 90°
06-11-949	06-61-922	06-61-934	06-81-136	06-81-142	06-81-148		2 mm, 90°
06-11-950	06-61-923	06-61-935	06-81-137	06-81-143	06-81-149		3 mm, 90°
06-11-951	06-61-924	06-61-936	06-81-138	06-81-144	06-81-150		4 mm, 90°
06-11-952	06-61-925	06-61-937	06-81-139	06-81-145	06-81-151		5 mm, 90°
06-11-953	06-61-926	06-61-938	06-81-140	06-81-146	06-81-152		6 mm, 90°



Schaftlänge
Length of shaft

180 mm 7"	200 mm 8"	230 mm 9"	250 mm 10"	280 mm 11"	300 mm 12"		
06-61-915	06-61-927	06-61-939	06-81-153	06-81-159	06-81-165	KERRISON	1 mm, 90°
06-61-916	06-61-928	06-61-940	06-81-154	06-81-160	06-81-166		2 mm, 90°
06-61-917	06-61-929	06-61-941	06-81-155	06-81-161	06-81-167		3 mm, 90°
06-61-918	06-61-930	06-61-942	06-81-156	06-81-162	06-81-168		4 mm, 90°
06-61-919	06-61-931	06-61-943	06-81-157	06-81-163	06-81-169		5 mm, 90°
06-61-920	06-61-932	06-61-944	06-81-158	06-81-164	06-81-170		6 mm, 90°

mit dünner Fußplatte
with thin footplate



Standard Line	Black Line
Oberfläche matt gebürstet Surface polished	Oberfläche schwarz, titanbeschichtet Surface black, titanium-coated
Beispiel-Artikel-Nr. Example Cat. No. 06-61-930	Beispiel-Artikel-Nr. Example Cat. No. 06-61-930B

D E T A C H A B L E

 Alle Stanzen mit integriertem Auswerfer
 All punches with integrated ejector

 1/2
KERRISON
06-61-910
 200 mm
 8"

 Schaftlänge
 Length of shaft

		180 mm 7"	200 mm 8"	230 mm 9"	250 mm 10"	280 mm 11"	300 mm 12"
1 mm, 130° (40°)	KERRISON	06-11-930	06-61-900	06-61-902	06-81-171	06-81-177	06-81-183
2 mm, 130° (40°)		06-11-931	06-61-990	06-11-943	06-81-172	06-81-178	06-81-184
3 mm, 130° (40°)		06-11-932	06-61-991	06-11-944	06-81-173	06-81-179	06-81-185
4 mm, 130° (40°)		06-11-933	06-61-992	06-11-945	06-81-174	06-81-180	06-81-186
5 mm, 130° (40°)		06-11-934	06-61-993	06-11-946	06-81-175	06-81-181	06-81-187
6 mm, 130° (40°)		06-61-908	06-61-910	06-61-912	06-81-176	06-81-182	06-81-188

 mit dünner Fußplatte
 with thin footplate

 Schaftlänge
 Length of shaft

		180 mm 7"	200 mm 8"	230 mm 9"	250 mm 10"	280 mm 11"	300 mm 12"
1 mm, 130° (40°)	KERRISON	06-11-936	06-61-901	06-61-903	06-81-189	06-81-195	06-81-201
2 mm, 130° (40°)		06-11-937	06-61-994	06-61-904	06-81-190	06-81-196	06-81-202
3 mm, 130° (40°)		06-11-938	06-61-995	06-61-905	06-81-191	06-81-197	06-81-203
4 mm, 130° (40°)		06-11-939	06-61-996	06-61-906	06-81-192	06-81-198	06-81-204
5 mm, 130° (40°)		06-11-940	06-61-997	06-61-907	06-81-193	06-81-199	06-81-205
6 mm, 130° (40°)		06-61-909	06-61-911	06-61-913	06-81-194	06-81-200	06-81-206

Standard Line

 Oberfläche matt gebürstet
 Surface polished

 Beispiel-Artikel-Nr.
 Example Cat. No.

06-61-910
Black Line

 Oberfläche schwarz, titanbeschichtet
 Surface black, titanium-coated

 Beispiel-Artikel-Nr.
 Example Cat. No.

06-61-910B

D E T A C H A B L E



Alle Stanzen mit integriertem Auswerfer
All punches with integrated ejector

1/2
KERRISON
06-11-954
180 mm
6"

Schaftlänge
Length of shaft

180 mm 7"	200 mm 8"	230 mm 9"	250 mm 10"	280 mm 11"	300 mm 12"		
06-11-954	06-61-964	06-61-966	06-81-207	06-81-213	06-81-219	KERRISON	1 mm, 90°
06-11-955	06-61-974	06-61-982	06-81-208	06-81-214	06-81-220		2 mm, 90°
06-11-956	06-61-975	06-61-983	06-81-209	06-81-215	06-81-221		3 mm, 90°
06-11-957	06-61-976	06-61-984	06-81-210	06-81-216	06-81-222		4 mm, 90°
06-11-958	06-61-977	06-61-985	06-81-211	06-81-217	06-81-223		5 mm, 90°
06-11-959	06-61-965	06-61-967	06-81-212	06-81-218	06-81-224		6 mm, 90°



Schaftlänge
Length of shaft

180 mm 7"	200 mm 8"	230 mm 9"	250 mm 10"	280 mm 11"	300 mm 12"		
06-61-968	06-61-969	06-61-998	06-81-225	06-81-231	06-81-237	KERRISON	1 mm, 90°
06-61-970	06-61-978	06-61-986	06-81-226	06-81-232	06-81-238		2 mm, 90°
06-61-971	06-61-979	06-61-987	06-81-227	06-81-233	06-81-239		3 mm, 90°
06-61-972	06-61-980	06-61-988	06-81-228	06-81-234	06-81-240		4 mm, 90°
06-61-973	06-61-981	06-61-989	06-81-229	06-81-235	06-81-241		5 mm, 90°
06-61-950	06-61-951	06-61-952	06-81-230	06-81-236	06-81-242		6 mm, 90°

mit dünner Fußplatte
with thin footplate









Standard Line	Black Line
Oberfläche matt gebürstet Surface polished	Oberfläche schwarz, titanbeschichtet Surface black, titanium-coated
Beispiel-Artikel-Nr. Example Cat. No. 06-11-954	Beispiel-Artikel-Nr. Example Cat. No. 06-11-954B

Alle Stanzen mit integriertem Auswerfer
 All punches with integrated ejector







 1/2
KERRISON
06-06-663B
 200 mm
 8"

Schaftlänge
Length of shaft

		180 mm 7"	200 mm 8"	230 mm 9"	250 mm 10"	280 mm 11"	300 mm 12"
 1 mm, 130° (40°)	KERRISON	06-06-715	06-06-691	06-06-674	06-76-125	06-06-696	06-76-131
 2 mm, 130° (40°)		06-06-717	06-06-737	06-06-682	06-76-126	06-06-686	06-76-132
 3 mm, 130° (40°)		06-06-720	06-06-738	06-06-683	06-76-127	06-06-687	06-76-133
 4 mm, 130° (40°)		06-06-724	06-06-727	06-06-684	06-76-128	06-06-688	06-76-134
 5 mm, 130° (40°)		06-06-722	06-06-728	06-06-685	06-76-129	06-06-689	06-76-135
 6 mm, 130° (40°)		06-06-726	06-06-729	06-56-735	06-76-130	06-06-690	06-76-136

 mit dünner Fußplatte
 with thin footplate

Schaftlänge
Length of shaft

		180 mm 7"	200 mm 8"	230 mm 9"	250 mm 10"	280 mm 11"	300 mm 12"
 1 mm, 130° (40°)	KERRISON	06-06-771	06-06-661	06-06-734	06-76-501	06-06-673	06-76-509
 2 mm, 130° (40°)		06-06-772	06-06-662	06-06-746	06-76-502	06-06-666	06-76-510
 3 mm, 130° (40°)		06-06-773	06-06-663	06-06-747	06-76-503	06-06-667	06-76-511
 4 mm, 130° (40°)		06-06-769	06-06-664	06-06-748	06-76-504	06-06-668	06-76-512
 5 mm, 130° (40°)		06-06-770	06-06-665	06-06-749	06-76-505	06-06-669	06-76-513
 6 mm, 130° (40°)		06-56-736	06-56-742	06-56-744	06-76-506	06-76-508	06-76-514

Standard Line

 Oberfläche matt gebürstet
 Surface polished

 Beispiel-Artikel-Nr. **06-06-663**
 Example Cat. No.

Black Line

 Oberfläche schwarz, titanbeschichtet
 Surface black, titanium-coated

 Beispiel-Artikel-Nr. **06-06-663B**
 Example Cat. No.



Alle Stanzen mit integriertem Auswerfer
All punches with integrated ejector

1/2
KERRISON
06-06-718
180 mm
7"

Schaftlänge
Length of shaft

180 mm 7"	200 mm 8"	230 mm 9"	250 mm 10"	280 mm 11"	300 mm 12"		
06-06-716	06-06-025	06-56-707	06-76-101	06-76-515	06-76-107	KERRISON	1 mm, 90°
06-06-718	06-06-026	06-56-708	06-76-102	06-76-516	06-76-108		2 mm, 90°
06-06-750	06-06-027	06-56-709	06-76-103	06-76-517	06-76-109		3 mm, 90°
06-06-752	06-06-028	06-56-710	06-76-104	06-76-518	06-76-110		4 mm, 90°
06-06-754	06-06-029	06-56-711	06-76-105	06-76-519	06-76-111		5 mm, 90°
06-06-755	06-06-076	06-56-712	06-76-106	06-76-520	06-76-112		6 mm, 90°



Schaftlänge
Length of shaft

180 mm 7"	200 mm 8"	230 mm 9"	250 mm 10"	280 mm 11"	300 mm 12"		
06-06-115	06-06-077	06-56-727	06-76-521	06-76-527	06-76-533	KERRISON	1 mm, 90°
06-06-116	06-06-078	06-56-728	06-76-522	06-76-528	06-76-534		2 mm, 90°
06-06-117	06-06-079	06-56-729	06-76-523	06-76-529	06-76-535		3 mm, 90°
06-06-118	06-06-080	06-56-730	06-76-524	06-76-530	06-76-536		4 mm, 90°
06-06-119	06-06-085	06-56-731	06-76-525	06-76-531	06-76-537		5 mm, 90°
06-56-720	06-56-726	06-56-732	06-76-526	06-76-532	06-76-538		6 mm, 90°

mit dünner Fußplatte
with thin footplate



Standard Line	Black Line
Oberfläche matt gebürstet Surface polished	Oberfläche schwarz, titanbeschichtet Surface black, titanium-coated
Beispiel-Artikel-Nr. Example Cat. No. 06-06-718	Beispiel-Artikel-Nr. Example Cat. No. 06-06-718B









Alle Stanzen mit integriertem Auswerfer
 All punches with integrated ejector

1/2
KERRISON
06-06-712
 180 mm
 7"

Schaftlänge
 Length of shaft









		180 mm 7"	200 mm 8"	230 mm 9"	250 mm 10"	280 mm 11"	300 mm 12"
 1 mm, 130° (40°)	KERRISON	06-06-711	06-56-779	06-56-785	06-76-137	06-76-539	06-76-143
 2 mm, 130° (40°)		06-06-712	06-56-780	06-06-692	06-76-138	06-76-540	06-76-144
 3 mm, 130° (40°)		06-06-713	06-56-781	06-06-693	06-76-139	06-76-541	06-76-145
 4 mm, 130° (40°)		06-06-714	06-56-782	06-06-694	06-76-140	06-76-542	06-76-146
 5 mm, 130° (40°)		06-06-725	06-56-783	06-06-695	06-76-141	06-76-543	06-76-147
 6 mm, 130° (40°)		06-56-778	06-56-784	06-56-786	06-76-142	06-76-544	06-76-148

mit dünner Fußplatte
 with thin footplate



Schaftlänge
 Length of shaft

		180 mm 7"	200 mm 8"	230 mm 9"	250 mm 10"	280 mm 11"	300 mm 12"
 1 mm, 130° (40°)	KERRISON	06-06-781	06-56-788	06-56-794	06-76-545	06-76-551	06-76-557
 2 mm, 130° (40°)		06-06-782	06-56-789	06-56-795	06-76-546	06-76-552	06-76-558
 3 mm, 130° (40°)		06-06-783	06-56-790	06-56-796	06-76-547	06-76-553	06-76-559
 4 mm, 130° (40°)		06-06-784	06-56-791	06-56-797	06-76-548	06-76-554	06-76-560
 5 mm, 130° (40°)		06-06-785	06-56-792	06-56-798	06-76-549	06-76-555	06-76-561
 6 mm, 130° (40°)		06-56-787	06-56-793	06-56-799	06-76-550	06-76-556	06-76-562

Standard Line

Oberfläche matt gebürstet
 Surface polished

Beispiel-Artikel-Nr.
 Example Cat. No.

06-06-712

Black Line

Oberfläche schwarz, titanbeschichtet
 Surface black, titanium-coated

Beispiel-Artikel-Nr.
 Example Cat. No.







06-06-712B









Alle Stanzen mit integriertem Auswerfer
All punches with integrated ejector

1/2
KERRISON
06-06-721
180 mm
7"

Schaftlänge
Length of shaft

180 mm 7"	200 mm 8"	230 mm 9"	250 mm 10"	280 mm 11"	300 mm 12"		
06-06-741	06-56-745	06-56-895	06-76-113	06-76-563	06-76-119	KERRISON	1 mm, 90° 
06-06-719	06-06-828	06-56-896	06-76-114	06-76-564	06-76-120		2 mm, 90° 
06-06-721	06-06-829	06-56-897	06-76-115	06-76-565	06-76-121		3 mm, 90° 
06-06-742	06-06-830	06-56-898	06-76-116	06-76-566	06-76-122		4 mm, 90° 
06-06-723	06-06-831	06-56-899	06-76-117	06-76-567	06-76-123		5 mm, 90° 
06-06-743	06-06-841	06-56-900	06-76-118	06-76-568	06-76-124		6 mm, 90° 

Schaftlänge
Length of shaft

180 mm 7"	200 mm 8"	230 mm 9"	250 mm 10"	280 mm 11"	300 mm 12"		
06-56-960	06-56-966	06-56-901	06-76-569	06-76-575	06-76-581	KERRISON	1 mm, 90° 
06-06-816	06-06-809	06-56-902	06-76-570	06-76-576	06-76-582		2 mm, 90° 
06-06-817	06-06-812	06-56-903	06-76-571	06-76-577	06-76-583		3 mm, 90° 
06-06-819	06-06-813	06-56-904	06-76-572	06-76-578	06-76-584		4 mm, 90° 
06-06-821	06-06-815	06-56-905	06-76-573	06-76-579	06-76-585		5 mm, 90° 
06-56-965	06-56-971	06-56-906	06-76-574	06-76-580	06-76-586		6 mm, 90° 

mit dünner Fußplatte
with thin footplate

Standard Line	Black Line
Oberfläche matt gebürstet Surface polished	Oberfläche schwarz, titanbeschichtet Surface black, titanium-coated
Beispiel-Artikel-Nr. Example Cat. No. 06-06-721	Beispiel-Artikel-Nr. Example Cat. No. 06-06-721B







Alle Stanzen mit integriertem Auswerfer
 All punches with integrated ejector

 1/2
KERRISON
06-06-739B
 200 mm
 8"

 mit Langhub
 with large jaw opening

 Schaftlänge
 Length of shaft

	180 mm 7"	200 mm 8"	230 mm 9"	250 mm 10"	280 mm 11"	300 mm 12"
--	--------------	--------------	--------------	---------------	---------------	---------------

		180 mm 7"	200 mm 8"	230 mm 9"	250 mm 10"	280 mm 11"	300 mm 12"
 1 mm, 130° (40°)	KERRISON	06-76-900	06-76-901	06-76-902	06-76-908	06-76-914	06-76-920
 2 mm, 130° (40°)		06-06-677	06-06-660	06-76-903	06-76-909	06-76-915	06-76-921
 3 mm, 130° (40°)		06-06-678	06-06-739	06-76-904	06-76-910	06-76-916	06-76-922
 4 mm, 130° (40°)		06-06-679	06-06-745	06-76-905	06-76-911	06-76-917	06-76-923
 5 mm, 130° (40°)		06-06-680	06-06-751	06-76-906	06-76-912	06-76-918	06-76-924
 6 mm, 130° (40°)		06-06-681	06-06-753	06-76-907	06-76-913	06-76-919	06-76-925

Standard Line

 Oberfläche matt gebürstet
 Surface polished

 Beispiel-Artikel-Nr. **06-06-739**
 Example Cat. No.

Black Line

 Oberfläche schwarz, titanbeschichtet
 Surface black, titanium-coated

 Beispiel-Artikel-Nr. **06-06-739B**
 Example Cat. No.



Alle Stanzen mit integriertem Auswerfer
 All punches with integrated ejector







1/2
KERRISON
06-06-136
 180 mm
 7"

Schaftlänge
 Length of shaft

180 mm 200 mm 230 mm 250 mm 280 mm 300 mm
 7" 8" 9" 10" 11" 12"

mit Langhub
 with large jaw opening



06-76-926	06-76-928	06-76-930	06-76-936	06-76-942	06-76-948	KERRISON	1 mm, 90°	
06-76-927	06-76-929	06-76-931	06-76-937	06-76-943	06-76-949		2 mm, 90°	
06-06-136	06-06-086	06-76-932	06-76-938	06-76-944	06-76-950		3 mm, 90°	
06-06-137	06-06-087	06-76-933	06-76-939	06-76-945	06-76-951		4 mm, 90°	
06-06-138	06-06-088	06-76-934	06-76-940	06-76-946	06-76-952		5 mm, 90°	
06-06-139	06-06-089	06-76-935	06-76-941	06-76-947	06-76-953		6 mm, 90°	

Standard Line	Black Line
Oberfläche matt gebürstet Surface polished	Oberfläche schwarz, titanbeschichtet Surface black, titanium-coated
Beispiel-Artikel-Nr. Example Cat. No. 06-06-136	Beispiel-Artikel-Nr. Example Cat. No. 06-06-136B

D E T A C H A B L E

 Alle Stanzen mit integriertem Auswerfer
 All punches with integrated ejector

 1/2
KERRISON
06-76-426
 230 mm
 9"

Schaftlänge
Length of shaft

 180 mm 200 mm 230 mm
 7" 8" 9"

Ø	KERRISON	06-76-400	06-76-412	06-76-424			
1 mm, 130° (40°)	aufwärts gebogen <i>curved up</i>	06-76-400	06-76-412	06-76-424			
2 mm, 130° (40°)		06-76-401	06-76-413	06-76-425			
3 mm, 130° (40°)		06-76-402	06-76-414	06-76-426			
4 mm, 130° (40°)		06-76-403	06-76-415	06-76-427			
5 mm, 130° (40°)		06-76-404	06-76-416	06-76-428			
6 mm, 130° (40°)		06-76-405	06-76-417	06-76-429			

 Foraminotomie-Stanzen
 Foraminotomy Punches

Schaftlänge
Length of shaft

 180 mm 200 mm 230 mm
 7" 8" 9"

Ø	KERRISON	06-76-406	06-76-418	06-76-430			
1 mm, 130° (40°)	abwärts gebogen <i>curved down</i>	06-76-406	06-76-418	06-76-430			
2 mm, 130° (40°)		06-76-407	06-76-419	06-76-431			
3 mm, 130° (40°)		06-76-408	06-76-420	06-76-432			
4 mm, 130° (40°)		06-76-409	06-76-421	06-76-433			
5 mm, 130° (40°)		06-76-410	06-76-422	06-76-434			
6 mm, 130° (40°)		06-76-411	06-76-423	06-76-435			

 Foraminotomie-Stanzen
 Foraminotomy Punches

Standard Line

 Oberfläche matt gebürstet
 Surface polished

 Beispiel-Artikel-Nr. **06-76-426**
 Example Cat. No.

Black Line

 Oberfläche schwarz, titanbeschichtet
 Surface black, titanium-coated

 Beispiel-Artikel-Nr. **06-76-426B**
 Example Cat. No.



Alle Stanzen mit integriertem Auswerfer
 All punches with integrated ejector

1/2
KERRISON
06-76-052
 200 mm
 8"



Schaftlänge
 Length of shaft

180 mm 200 mm 230 mm
 7" 8" 9"

06-76-050	06-76-052	06-56-054				KERRISON	1 mm, 130° (40°)
06-76-150	06-06-466	06-56-055					2 mm, 130° (40°)
06-76-151	06-06-467	06-56-056					3 mm, 130° (40°)
06-76-152	06-06-468	06-56-057					4 mm, 130° (40°)
06-76-153	06-06-469	06-56-058					5 mm, 130° (40°)
06-76-051	06-76-053	06-56-059					6 mm, 130° (40°)

Foraminotomie-Stanzen
 Foraminotomy Punches

Schaftlänge
 Length of shaft

180 mm 200 mm 230 mm
 7" 8" 9"

06-76-060	06-76-063	06-76-066				KERRISON	1 mm, 130° (40°)
06-76-158	06-76-161	06-76-067					2 mm, 130° (40°)
06-76-159	06-76-162	06-76-068					3 mm, 130° (40°)
06-76-160	06-76-163	06-76-069					4 mm, 130° (40°)
06-76-061	06-76-064	06-76-070					5 mm, 130° (40°)
06-76-062	06-76-065	06-76-071					6 mm, 130° (40°)

Foraminotomie-Stanzen
 Foraminotomy Punches

Standard Line	Black Line
Oberfläche matt gebürstet <i>Surface polished</i>	Oberfläche schwarz, titanbeschichtet <i>Surface black, titanium-coated</i>
Beispiel-Artikel-Nr. <i>Example Cat. No.</i> 06-76-052	Beispiel-Artikel-Nr. <i>Example Cat. No.</i> 06-76-052B

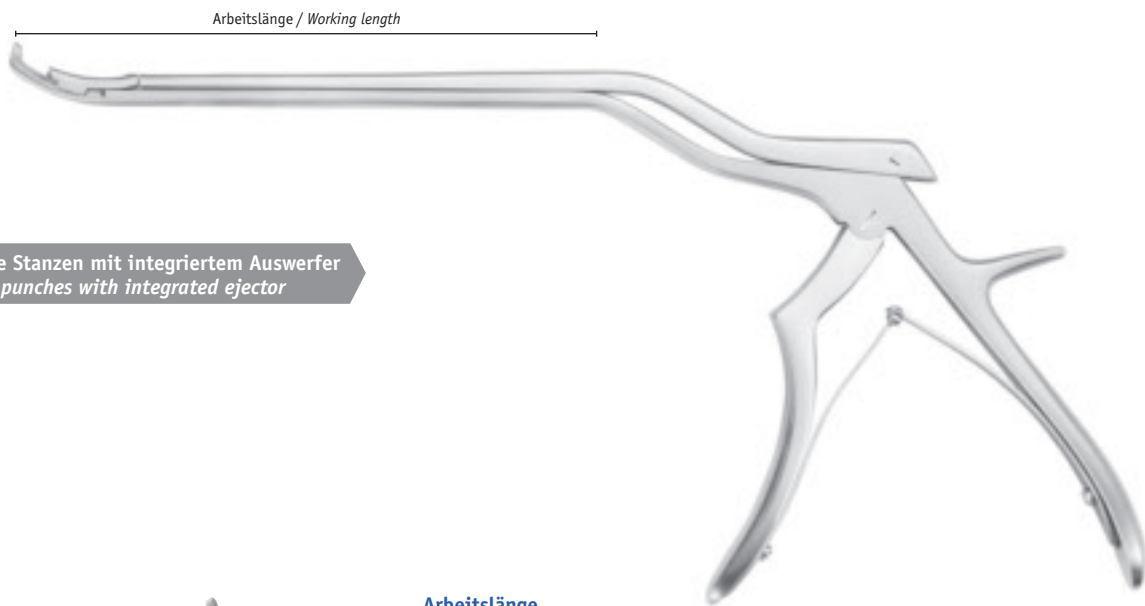

Alle Stanzen mit integriertem Auswerfer
 All punches with integrated ejector

1/2
KERRISON
06-76-308
 150 mm
 6"



Arbeitslänge
Working length

110 mm 150 mm 180 mm
 4 1/3" 6" 7"

Ø	Winkel	KURVENRICHUNG	110 mm	150 mm	180 mm			
1 mm	130° (40°)	aufwärts gebogen curved up	06-76-300	06-76-306	06-76-312			
2 mm	130° (40°)		06-76-301	06-76-307	06-76-313			
3 mm	130° (40°)		06-76-302	06-76-308	06-76-314			
4 mm	130° (40°)		06-76-303	06-76-309	06-76-315			
5 mm	130° (40°)		06-76-304	06-76-310	06-76-316			
6 mm	130° (40°)		06-76-305	06-76-311	06-76-317			

Foraminotomie-Stanzen
 Foraminotomy Punches



Arbeitslänge
Working length

110 mm 150 mm 180 mm
 4 1/3" 6" 7"

Ø	Winkel	KURVENRICHUNG	110 mm	150 mm	180 mm			
1 mm	130° (40°)	abwärts gebogen curved down	06-76-318	06-76-324	06-76-330			
2 mm	130° (40°)		06-76-319	06-76-325	06-76-331			
3 mm	130° (40°)		06-76-320	06-76-326	06-76-332			
4 mm	130° (40°)		06-76-321	06-76-327	06-76-333			
5 mm	130° (40°)		06-76-322	06-76-328	06-76-334			
6 mm	130° (40°)		06-76-323	06-76-329	06-76-335			

Foraminotomie-Stanzen
 Foraminotomy Punches

Standard Line

Oberfläche matt gebürstet
 Surface polished

Beispiel-Artikel-Nr. **06-76-308**
 Example Cat. No.

Black Line

Oberfläche schwarz, titanbeschichtet
 Surface black, titanium-coated

Beispiel-Artikel-Nr. **06-76-308B**
 Example Cat. No.

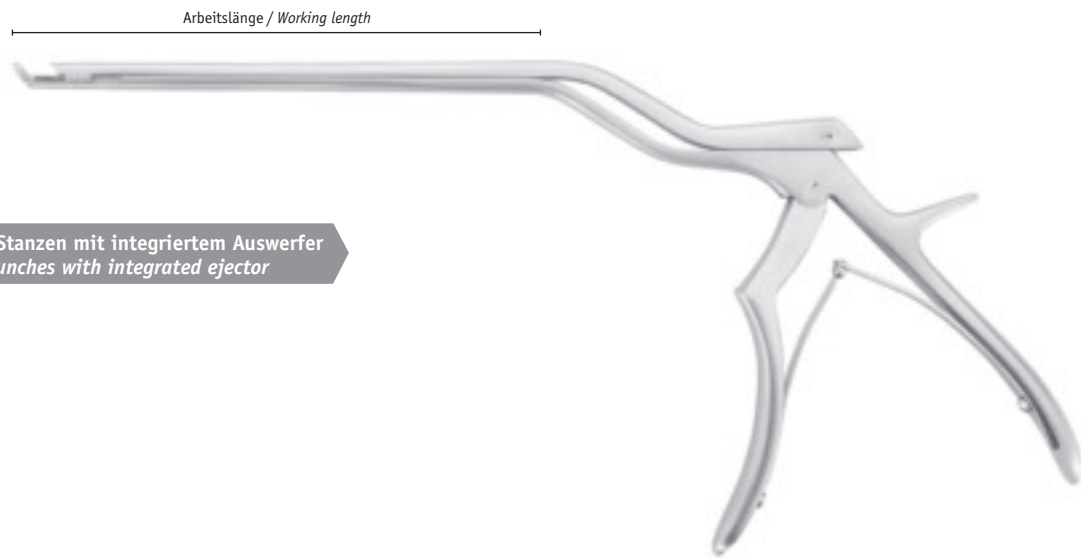

Alle Stanzen mit integriertem Auswerfer
 All punches with integrated ejector

1/2
KERRISON
06-76-199
 150 mm
 6"

Arbeitslänge
Working length

110 mm 150 mm 180 mm
 4 1/8" 6" 7"



06-76-190	06-76-196	06-76-202				KERRISON	1 mm, 130° (40°)
06-76-191	06-76-197	06-76-203					2 mm, 130° (40°)
06-76-192	06-76-198	06-76-204					3 mm, 130° (40°)
06-76-193	06-76-199	06-76-205					4 mm, 130° (40°)
06-76-194	06-76-200	06-76-206					5 mm, 130° (40°)
06-76-195	06-76-201	06-76-207					6 mm, 130° (40°)

Arbeitslänge
Working length

110 mm 150 mm 180 mm
 4 1/8" 6" 7"



06-76-170	06-76-176	06-76-182				KERRISON	1 mm, 90°
06-76-171	06-76-177	06-06-496					2 mm, 90°
06-76-172	06-76-178	06-06-497					3 mm, 90°
06-76-173	06-76-179	06-06-498					4 mm, 90°
06-76-174	06-76-180	06-06-499					5 mm, 90°
06-76-175	06-76-181	06-76-187					6 mm, 90°

Standard Line	Black Line
Oberfläche matt gebürstet Surface polished	Oberfläche schwarz, titanbeschichtet Surface black, titanium-coated
Beispiel-Artikel-Nr. Example Cat. No. 06-76-199	Beispiel-Artikel-Nr. Example Cat. No. 06-76-199B

Arbeitslänge / Working length

 Alle Stanzen mit integriertem Auswerfer
 All punches with integrated ejector

 1/2
KERRISON
06-76-258
 150 mm
 6"

Arbeitslänge
Working length

 Bajonett links
 bayonet left

 110 mm 150 mm 180 mm
 4 1/3" 6" 7"

	KERRISON	06-76-250	06-76-256	06-76-262			
1 mm, 130° (40°)		06-76-251	06-76-257	06-76-263			
2 mm, 130° (40°)		06-76-252	06-76-258	06-76-264			
3 mm, 130° (40°)		06-76-253	06-76-259	06-76-265			
4 mm, 130° (40°)		06-76-254	06-76-260	06-76-266			
5 mm, 130° (40°)		06-76-255	06-76-261	06-76-267			
6 mm, 130° (40°)							

Arbeitslänge
Working length

 Bajonett rechts
 bayonet right

 110 mm 150 mm 180 mm
 4 1/3" 6" 7"

	KERRISON	06-76-268	06-76-274	06-76-280			
1 mm, 130° (40°)		06-76-269	06-76-275	06-76-281			
2 mm, 130° (40°)		06-76-270	06-76-276	06-76-282			
3 mm, 130° (40°)		06-76-271	06-76-277	06-76-283			
4 mm, 130° (40°)		06-76-272	06-76-278	06-76-284			
5 mm, 130° (40°)		06-76-273	06-76-279	06-76-285			
6 mm, 130° (40°)							

Standard Line
 Oberfläche matt gebürstet
 Surface polished

 Beispiel-Artikel-Nr.
 Example Cat. No.
06-76-258**Black Line**
 Oberfläche schwarz, titanbeschichtet
 Surface black, titanium-coated

 Beispiel-Artikel-Nr.
 Example Cat. No.
06-76-258B

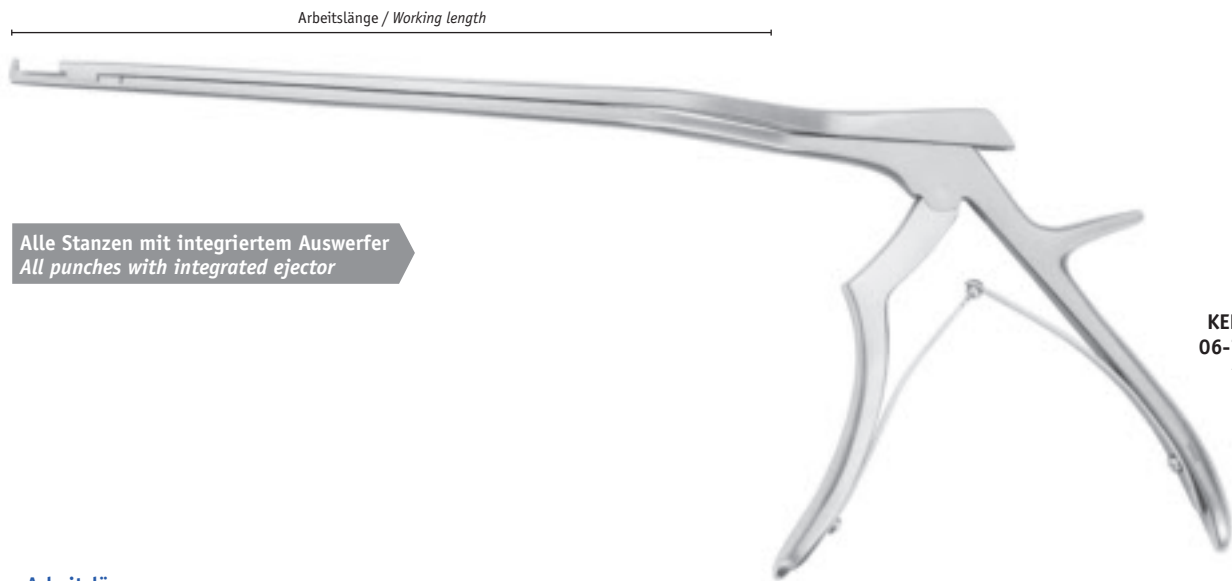

Alle Stanzen mit integriertem Auswerfer
 All punches with integrated ejector

1/2
KERRISON
06-76-217
 150 mm
 6"

Arbeitslänge
 Working length

110 mm 150 mm 180 mm
 4 1/3" 6" 7"

Bajonett links
 bayonet left



06-76-210	06-76-216	06-76-222					KERRISON 1 mm, 90°	
06-76-211	06-76-217	06-76-223						2 mm, 90°
06-76-212	06-76-218	06-76-224						3 mm, 90°
06-76-213	06-76-219	06-76-225						4 mm, 90°
06-76-214	06-76-220	06-76-226						5 mm, 90°
06-76-215	06-76-221	06-76-227						6 mm, 90°

Arbeitslänge
 Working length

110 mm 150 mm 180 mm
 4 1/3" 6" 7"



Bajonett rechts
 bayonet right





06-76-230	06-76-236	06-76-242					KERRISON 1 mm, 90°	
06-76-231	06-76-237	06-76-243						2 mm, 90°
06-76-232	06-76-238	06-76-244						3 mm, 90°
06-76-233	06-76-239	06-76-245						4 mm, 90°
06-76-234	06-76-240	06-76-246						5 mm, 90°
06-76-235	06-76-241	06-76-247						6 mm, 90°

Standard Line	Black Line
Oberfläche matt gebürstet Surface polished Beispiel-Artikel-Nr. Example Cat. No. 06-76-217	Oberfläche schwarz, titanbeschichtet Surface black, titanium-coated Beispiel-Artikel-Nr. Example Cat. No. 06-76-217B

 1/2
HAJEK-KOFLER
15-11-740
 140 mm
 5½"

		Artikel-Nr. Cat. No.	Schaftlänge Length of shaft
	3,5 mm, 90°	HAJEK-KOFLER 15-11-740	140 mm / 5½"
	4 mm, 90°	15-11-742	140 mm / 5½"



		Artikel-Nr. Cat. No.	Schaftlänge Length of shaft
	3,5 mm, 90°	HAJEK-KOFLER 15-11-741	140 mm / 5½"
	4 mm, 90°	15-11-743	140 mm / 5½"

Standard Line

 Oberfläche matt gebürstet
 Surface polished

 Beispiel-Artikel-Nr.
 Example Cat. No. **15-11-740**
Black Line

 Oberfläche schwarz, titanbeschichtet
 Surface black, titanium-coated





 Beispiel-Artikel-Nr.
 Example Cat. No. **15-11-740B**



1/2
RANEY
06-56-690
150 mm
6"

Artikel-Nr. Cat. No.	Schaftlänge Length of shaft		
06-56-690	150 mm / 6"	RANEY	6 mm, 90° 
06-56-691	180 mm / 7"		



Artikel-Nr. Cat. No.	Schaftlänge Length of shaft		
15-61-711	85 mm / 3 3/4"	KERRISON	3 mm, 90° 
15-11-711	85 mm / 3 3/4"		4 mm, 90° 
15-11-712	85 mm / 3 3/4"		5 mm, 90° 
15-61-712	85 mm / 3 3/4"		6 mm, 90° 









1/2
KERRISON
15-61-711
85 mm
3 3/4"

Standard Line	Black Line
Oberfläche matt gebürstet <i>Surface polished</i>	Oberfläche schwarz, titanbeschichtet <i>Surface black, titanium-coated</i>
Beispiel-Artikel-Nr. Example Cat. No. 15-61-711	Beispiel-Artikel-Nr. Example Cat. No. 15-61-711B

 1/2
**FERRIS-SMITH-
KERRISON**
 13-03-322
 180 mm
 7"

Schaftlänge
Length of shaft

180 mm 7"	200 mm 8"	280 mm 11"
--------------	--------------	---------------

		180 mm 7"	200 mm 8"	280 mm 11"			
 1 mm, 130° (40°)	FERRIS-SMITH-KERRISON	13-03-300	13-03-306	13-03-312			
 2 mm, 130° (40°)		13-03-301	13-03-307	13-03-313			
 3 mm, 130° (40°)		13-03-302	13-03-308	13-03-314			
 4 mm, 130° (40°)		13-03-303	13-03-309	13-03-315			
 5 mm, 130° (40°)		13-03-304	13-03-310	13-03-316			
 6 mm, 130° (40°)		13-03-305	13-03-311	13-03-317			

Standard Line

 Oberfläche matt gebürstet
Surface polished

 Beispiel-Artikel-Nr. [13-03-322](#)
 Example Cat. No.

Black Line

 Oberfläche schwarz, titanbeschichtet
Surface black, titanium-coated

 Beispiel-Artikel-Nr. [13-03-322B](#)
 Example Cat. No.



1/2
**FERRIS-SMITH-
KERRISON**
13-03-322
180 mm
7"

Schaftlänge
Length of shaft

180 mm 200 mm 280 mm
7" 8" 11"



13-03-318	13-03-324	13-03-330				FERRIS-SMITH-KERRISON	1 mm, 90°	
13-03-319	13-03-325	13-03-331					2 mm, 90°	
13-03-320	13-03-326	13-03-332					3 mm, 90°	
13-03-321	13-03-327	13-03-333					4 mm, 90°	
13-03-322	13-03-328	13-03-334					5 mm, 90°	
13-03-323	13-03-329	13-03-335					6 mm, 90°	

Schaftlänge
Length of shaft

180 mm 200 mm 280 mm
7" 8" 11"



13-53-300	13-53-306	13-53-312				FERRIS-SMITH-KERRISON	1 mm, 90°	
13-53-301	13-53-307	13-53-313					2 mm, 90°	
13-53-302	13-53-308	13-53-314					3 mm, 90°	
13-53-303	13-53-309	13-53-315					4 mm, 90°	
13-53-304	13-53-310	13-53-316					5 mm, 90°	
13-53-305	13-53-311	13-53-317					6 mm, 90°	

Standard Line	Black Line
Oberfläche matt gebürstet <i>Surface polished</i>	Oberfläche schwarz, titanbeschichtet <i>Surface black, titanium-coated</i>
Beispiel-Artikel-Nr. <i>Example Cat. No.</i> 13-03-322	Beispiel-Artikel-Nr. <i>Example Cat. No.</i> 13-03-322B

Besonders stabile Maulkonstruktion.

Firm construction of jaw.

Der zerlegte Rongeur bleibt als ein Teil zusammen.

The detached rongeur remains one part.

Die schwarze Titan-Nitrit-Beschichtung verhindert Reflexionen.

The black titanium-nitrite coating avoids reflections.

Der goldene Griff weist auf die Zerlegbarkeit hin.

The golden handle refers to the detachability.

Die Maulbreite wird zweifach angezeigt.

Jaw size is marked on the rongeur twice.

Einfaches Zerlegen per Knopf.

Quick and easy disassembling by pull button.

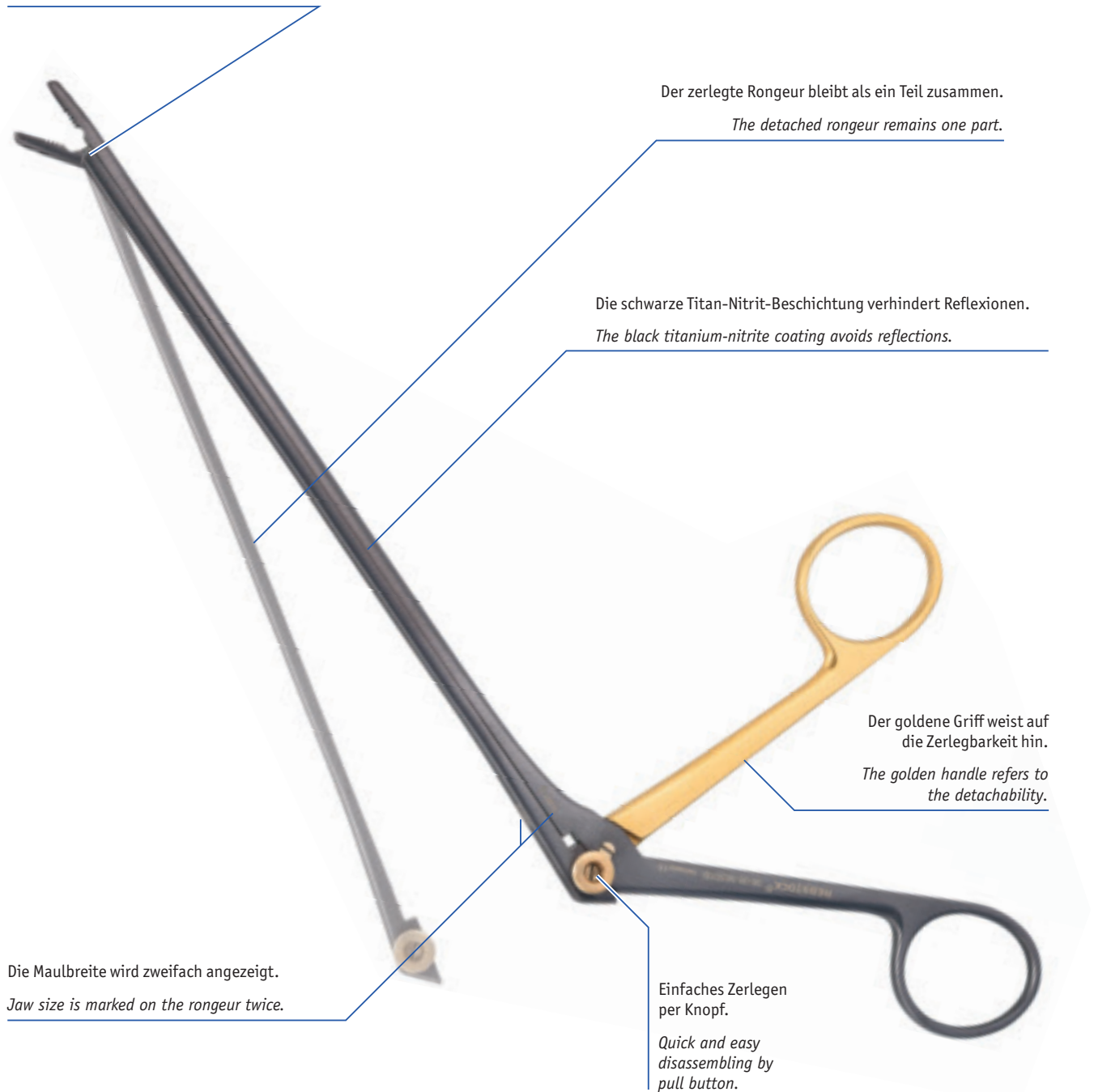

Standard Line	D E T A C H A B L E
Oberfläche matt gebürstet Surface polished Beispiel-Artikel-Nr. 06-06-543 <i>Example Cat. No.</i>	zerlegbar detachable Beispiel-Artikel-Nr. 06-06-543DT <i>Example Cat. No.</i>
Black Line	D E T A C H A B L E
Oberfläche schwarz, titanbeschichtet Surface black, titanium-coated Beispiel-Artikel-Nr. 06-06-543B <i>Example Cat. No.</i>	zerlegbar detachable Beispiel-Artikel-Nr. 06-06-543DTB <i>Example Cat. No.</i>

Demontage
Disassembly

Auslöseknopf ziehen und
Schieber nach oben klappen.
*Pull the release button and lift
the sliding part up.*



Der Rongeur ist zerlegt. Alle
Teile bleiben miteinander
verbunden.
*The rongeur is disassembled.
All parts remain connected with
each other.*

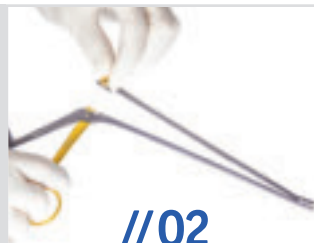

Montage
Assembly



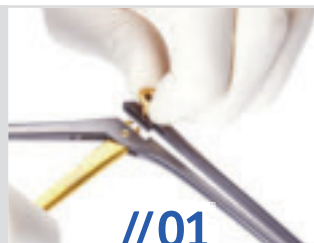

Schieber bei gezogenem Auslöseknopf in Hauptteil einsetzen.
*When the release button is
pulled, insert the sliding part in
the main part.*

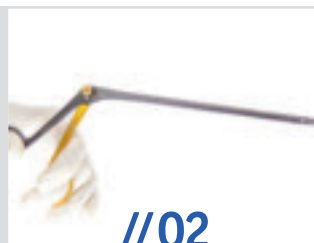

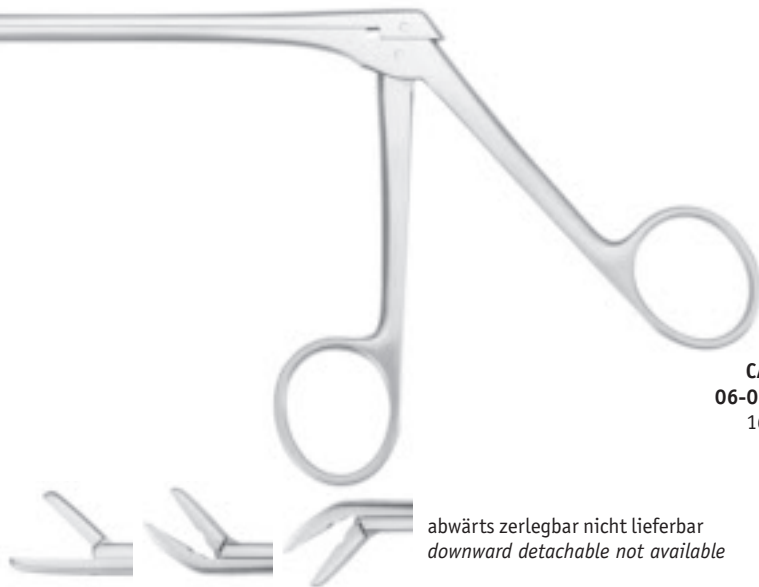
Der Rongeur ist montiert und
einsatzbereit.
*The rongeur is assembled and
ready for use.*





		Artikel-Nr. Cat. No.	Artikel-Nr. Cat. No.	Artikel-Nr. Cat. No.	Schaftlänge Length of shaft
1/1 2 x 12 mm 	CASPAR	06-06-502	06-56-512	06-56-522	140 mm / 5 1/2"
		06-06-532	06-56-542	06-56-552	160 mm / 6 3/4"
		06-06-562	06-56-572	06-56-582	185 mm / 7 3/4"
1/1 3 x 12 mm 	CASPAR	06-06-503	06-06-513	06-06-523	140 mm / 5 1/2"
		06-06-533	06-06-543	06-06-553	160 mm / 6 3/4"
		06-06-563	06-06-573	06-06-583	185 mm / 7 3/4"
1/1 4 x 14 mm 	CASPAR	06-06-504	06-06-514	06-06-524	140 mm / 5 1/2"
		06-06-534	06-06-544	06-06-554	160 mm / 6 3/4"
		06-06-564	06-06-574	06-06-584	185 mm / 7 3/4"
1/1 5 x 14 mm 	CASPAR	06-06-505	06-06-515	06-56-525	140 mm / 5 1/2"
		06-06-535	06-06-545	06-56-555	160 mm / 6 3/4"
		06-06-565	06-06-575	06-56-585	185 mm / 7 3/4"
1/1 6 x 16 mm 	CASPAR	06-06-506			140 mm / 5 1/2"
		06-06-536			160 mm / 6 3/4"
		06-06-566			185 mm / 7 3/4"

Standard Line

 Oberfläche matt gebürstet
 Surface polished

 Beispiel-Artikel-Nr.
 Example Cat. No. **06-06-543**
D E T A C H A B L E

 zerlegbar
 detachable

 Beispiel-Artikel-Nr.
 Example Cat. No. **06-06-543DT**
Black Line

 Oberfläche schwarz, titanbeschichtet
 Surface black, titanium-coated

 Beispiel-Artikel-Nr.
 Example Cat. No. **06-06-543B**
D E T A C H A B L E

 zerlegbar
 detachable

 Beispiel-Artikel-Nr.
 Example Cat. No. **06-06-543DTB**



zerlegbare Rongeur siehe
Fußnote und Seite 366
Rongeurs detachable please refer
to footnote and page 366

1/2
CASPAR
06-56-837
180 mm
7"





Artikel-Nr. Cat. No.	Artikel-Nr. Cat. No.	Artikel-Nr. Cat. No.	Schaftlänge Length of shaft		
06-56-830	06-56-840	06-56-850	120 mm / 4¾"	CASPAR	1/1 2 mm
06-06-832	06-06-842	06-06-852	155 mm / 6"		
06-56-832	06-56-842	06-56-852	180 mm / 7"		
06-56-833	06-56-843	06-56-853	120 mm / 4¾"	CASPAR	
06-06-833	06-06-843	06-06-853	155 mm / 6"		
06-56-837	06-56-847	06-56-857	180 mm / 7"		
06-56-834	06-56-844	06-56-854	120 mm / 4¾"	CASPAR	
06-06-834	06-06-844	06-06-854	155 mm / 6"		
06-56-836	06-56-846	06-56-856	180 mm / 7"		
06-56-838	06-56-848	06-56-858	120 mm / 4¾"	CASPAR	
06-06-835	06-56-849	06-56-859	155 mm / 6"		
06-56-841	06-56-851	06-56-861	180 mm / 7"		

Standard Line	D E T A C H A B L E
Oberfläche matt gebürstet <i>Surface polished</i>	zerlegbar <i>detachable</i>
Beispiel-Artikel-Nr. Example Cat. No. 06-56-837	Beispiel-Artikel-Nr. Example Cat. No. 06-56-837DT
Black Line	D E T A C H A B L E
Oberfläche schwarz, titanbeschichtet <i>Surface black, titanium-coated</i>	zerlegbar <i>detachable</i>
Beispiel-Artikel-Nr. Example Cat. No. 06-56-837B	Beispiel-Artikel-Nr. Example Cat. No. 06-56-837DTB

 1/2
LOVE-GRUENWALD
06-06-806DT
 180 mm
 7"

 zerlegbare Rongeurs siehe
 Fußnote und Seite 366
*Rongeurs detachable please refer
 to footnote and page 366*

			Artikel-Nr. Cat. No.	Artikel-Nr. Cat. No.	Artikel-Nr. Cat. No.	Schaftlänge Length of shaft
1/1 1,5 x 10 mm 	CUSHING	06-76-800	06-76-805	06-76-810	130 mm / 5 1/8"	
		06-76-801	06-76-806	06-76-811	150 mm / 6"	
		06-76-802	06-76-807	06-76-812	180 mm / 7"	
		06-76-803	06-76-808	06-76-813	230 mm / 9"	
		06-76-804	06-76-809	06-76-814	280 mm / 11"	
1/1 2 x 10 mm 	CUSHING	06-06-799	06-56-769	06-56-760	130 mm / 5 1/8"	
		06-56-802	06-56-770	06-56-761	150 mm / 6"	
		06-06-803	06-56-771	06-56-762	180 mm / 7"	
		06-56-803	06-56-772	06-56-763	230 mm / 9"	
		06-56-804	06-56-773	06-56-764	280 mm / 11"	
1/1 3 x 10 mm 	LOVE-GRUENWALD	06-06-800	06-06-774	06-06-777	130 mm / 5 1/8"	
		06-56-800	06-56-774	06-56-777	150 mm / 6"	
		06-06-805	06-06-806	06-06-810	180 mm / 7"	
		06-56-805	06-56-811	06-56-810	230 mm / 9"	
		06-56-806	06-56-812	06-56-816	280 mm / 11"	

Standard Line	D E T A C H A B L E
Oberfläche matt gebürstet <i>Surface polished</i> Beispiel-Artikel-Nr. <i>Example Cat. No.</i> 06-06-806	zerlegbar <i>detachable</i> Beispiel-Artikel-Nr. <i>Example Cat. No.</i> 06-06-806DT
Black Line	D E T A C H A B L E
Oberfläche schwarz, titanbeschichtet <i>Surface black, titanium-coated</i> Beispiel-Artikel-Nr. <i>Example Cat. No.</i> 06-06-806B	zerlegbar <i>detachable</i> Beispiel-Artikel-Nr. <i>Example Cat. No.</i> 06-06-806DTB



1/2
CUSHING
06-56-771DT
180 mm
7"

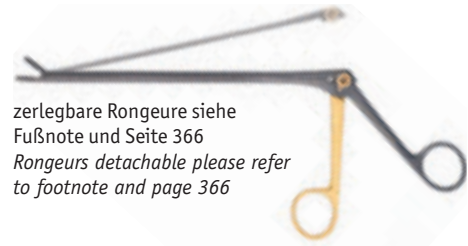

zerlegbare Rongeurs siehe
Fußnote und Seite 366
*Rongeurs detachable please refer
to footnote and page 366*



Artikel-Nr. Cat. No.	Artikel-Nr. Cat. No.	Artikel-Nr. Cat. No.	Schaftlänge Length of shaft		
06-06-801	06-06-775	06-06-778	130 mm / 5 1/8"	SPURLING	1/1 4 x 10 mm
06-56-801	06-56-775	06-56-807	150 mm / 6"		
06-06-807	06-06-814	06-06-811	180 mm / 7"		
06-56-808	06-56-814	06-56-817	230 mm / 9"		
06-56-809	06-56-815	06-56-818	280 mm / 11"		
06-06-767	06-06-776	06-76-823	130 mm / 5 1/8"	CUSHING	1/1 5 x 10 mm
06-76-815	06-76-819	06-76-824	150 mm / 6"		
06-76-816	06-76-820	06-76-825	180 mm / 7"		
06-76-817	06-76-821	06-76-826	230 mm / 9"		
06-76-818	06-76-822	06-76-827	280 mm / 11"		
06-06-768	06-76-832	06-76-837	130 mm / 5 1/8"	CUSHING	1/1 6 x 10 mm
06-76-828	06-76-833	06-76-838	150 mm / 6"		
06-76-829	06-76-834	06-76-839	180 mm / 7"		
06-76-830	06-76-835	06-76-840	230 mm / 9"		
06-76-831	06-76-836	06-76-841	280 mm / 11"		

Standard Line	D E T A C H A B L E
Oberfläche matt gebürstet <i>Surface polished</i> Beispiel-Artikel-Nr. <i>Example Cat. No.</i> 06-56-771	zerlegbar <i>detachable</i> Beispiel-Artikel-Nr. <i>Example Cat. No.</i> 06-56-771DT
Black Line	D E T A C H A B L E
Oberfläche schwarz, titanbeschichtet <i>Surface black, titanium-coated</i> Beispiel-Artikel-Nr. <i>Example Cat. No.</i> 06-56-771B	zerlegbar <i>detachable</i> Beispiel-Artikel-Nr. <i>Example Cat. No.</i> 06-56-771DTB

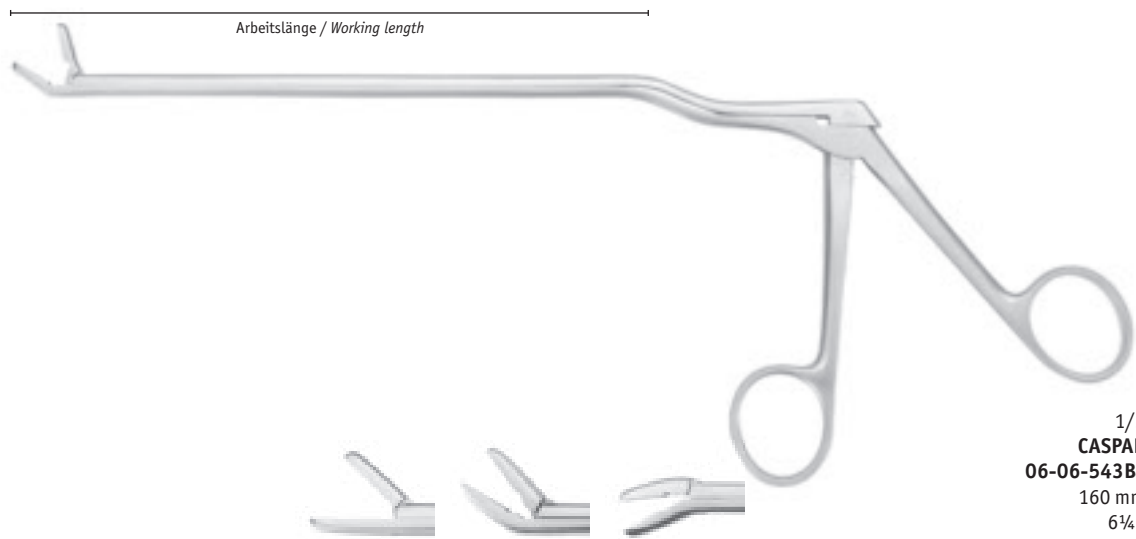
 Maulteil gefenestert und gezahnt
 Mouth fenestrated and serrated

 1/2
CASPAR
06-06-543BJ
 160 mm
 6¼"

		Artikel-Nr. Cat. No.	Artikel-Nr. Cat. No.	Artikel-Nr. Cat. No.	Arbeitslänge Working length
1/1 2 x 12 mm 	CASPAR	06-06-502BJ	06-56-512BJ	06-56-522BJ	140 mm / 5½"
		06-06-532BJ	06-56-542BJ	06-56-552BJ	160 mm / 6¼"
		06-06-562BJ	06-56-572BJ	06-56-582BJ	185 mm / 7¼"
1/1 3 x 12 mm 	CASPAR	06-06-503BJ	06-06-513BJ	06-06-523BJ	140 mm / 5½"
		06-06-533BJ	06-06-543BJ	06-06-553BJ	160 mm / 6¼"
		06-06-563BJ	06-06-573B	06-06-583BJ	185 mm / 7¼"
1/1 4 x 14 mm 	CASPAR	06-06-504BJ	06-06-514BJ	06-06-524BJ	140 mm / 5½"
		06-06-534BJ	06-06-544BJ	06-06-554BJ	160 mm / 6¼"
		06-06-564BJ	06-06-574BJ	06-06-584BJ	185 mm / 7¼"
1/1 5 x 14 mm 	CASPAR	06-06-505BJ	06-06-515BJ	06-56-525BJ	140 mm / 5½"
		06-06-535BJ	06-06-545BJ	06-56-555BJ	160 mm / 6¼"
		06-06-565BJ	06-06-575BJ	06-56-585BJ	185 mm / 7¼"
1/1 6 x 16 mm 	CASPAR	06-06-506BJ			140 mm / 5½"
		06-06-536BJ			160 mm / 6¼"
		06-06-566BJ			185 mm / 7¼"

Standard Line

 Oberfläche matt gebürstet
 Surface polished

 Beispiel-Artikel-Nr.
 Example Cat. No. **06-06-543BJ**
Black Line

 Oberfläche schwarz, titanbeschichtet
 Surface black, titanium-coated

 Beispiel-Artikel-Nr.
 Example Cat. No. **06-06-543BJB**

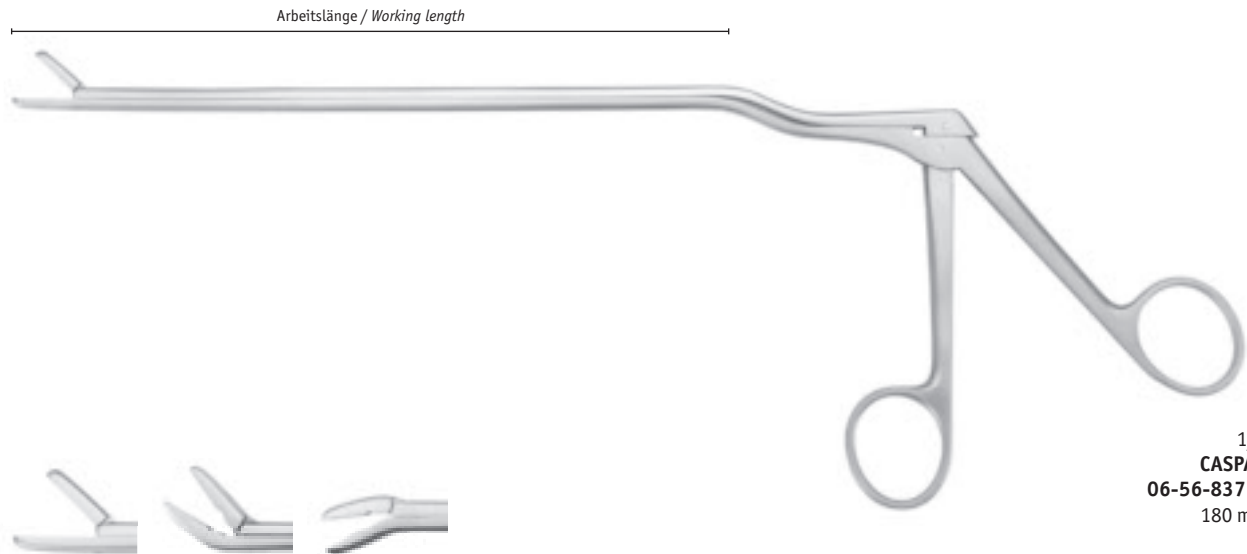

Artikel-Nr. Cat. No.	Artikel-Nr. Cat. No.	Artikel-Nr. Cat. No.	Arbeitslänge Working length		
06-56-830BJ	06-56-840BJ	06-56-850BJ	120 mm / 4 ³ / ₄ "	CASPAR	1/1 2 mm
06-06-832BJ	06-06-842BJ	06-06-852BJ	155 mm / 6"		
06-56-832BJ	06-56-842BJ	06-56-852BJ	180 mm / 7"		
06-56-833BJ	06-56-843BJ	06-56-853BJ	120 mm / 4 ³ / ₄ "	CASPAR	1/1 3 mm
06-06-833BJ	06-06-843BJ	06-06-853BJ	155 mm / 6"		
06-56-837BJ	06-56-847BJ	06-56-857BJ	180 mm / 7"		
06-56-834BJ	06-56-844BJ	06-56-854BJ	120 mm / 4 ³ / ₄ "	CASPAR	1/1 4 mm
06-06-834BJ	06-06-844BJ	06-06-854BJ	155 mm / 6"		
06-56-836BJ	06-56-846BJ	06-56-856BJ	180 mm / 7"		
06-56-838BJ	06-56-848BJ	06-56-858BJ	120 mm / 4 ³ / ₄ "	CASPAR	1/1 5 mm
06-06-835BJ	06-56-849BJ	06-56-859BJ	155 mm / 6"		
06-56-841BJ	06-56-851BJ	06-56-861BJ	180 mm / 7"		

Standard Line	Black Line
Oberfläche matt gebürstet <i>Surface polished</i> Beispiel-Artikel-Nr. Example Cat. No. 06-56-837BJ	Oberfläche schwarz, titanbeschichtet <i>Surface black, titanium-coated</i> Beispiel-Artikel-Nr. Example Cat. No. 06-56-837BJB

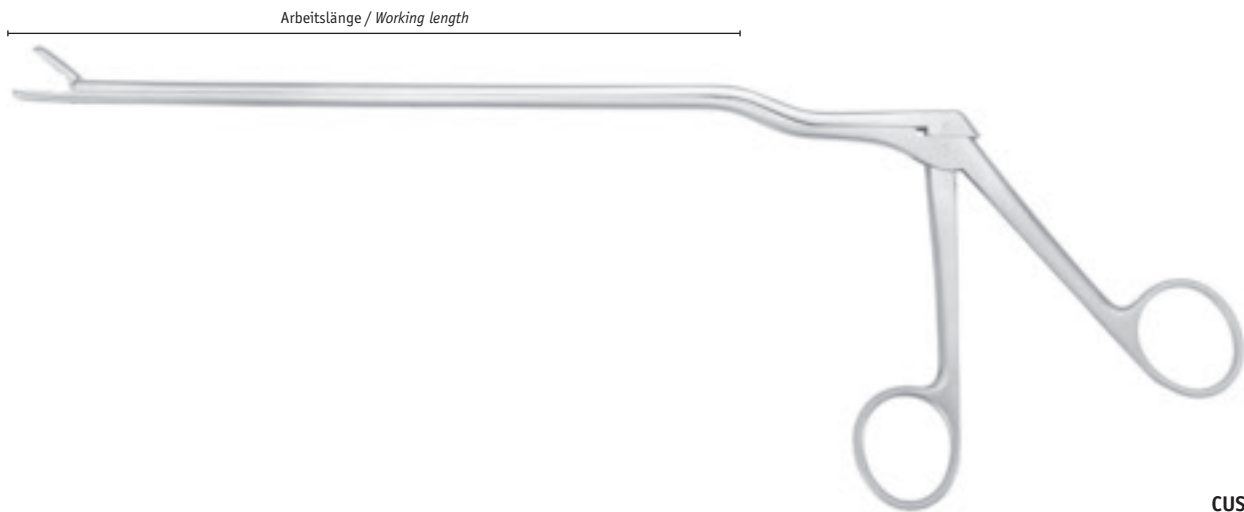
 1/2
CUSHING
06-06-807BJ
 180 mm
 7"

		Artikel-Nr. Cat. No.	Artikel-Nr. Cat. No.	Artikel-Nr. Cat. No.	Arbeitslänge Working length
1/1 1,5 x 10 mm	CUSHING	06-76-800BJ	06-76-805BJ	06-76-810BJ	130 mm / 5 1/8"
		06-76-801BJ	06-76-806BJ	06-76-811BJ	150 mm / 6"
		06-76-802BJ	06-76-807BJ	06-76-812BJ	180 mm / 7"
		06-76-803BJ	06-76-808BJ	06-76-813BJ	230 mm / 9"
		06-76-804BJ	06-76-809BJ	06-76-814BJ	280 mm / 11"
1/1 2 x 10 mm	CUSHING	06-06-799BJ	06-56-769BJ	06-56-760BJ	130 mm / 5 1/8"
		06-56-802BJ	06-56-770BJ	06-56-761BJ	150 mm / 6"
		06-06-803BJ	06-56-771BJ	06-56-762BJ	180 mm / 7"
		06-56-803BJ	06-56-772BJ	06-56-763BJ	230 mm / 9"
		06-56-804BJ	06-56-773BJ	06-56-764BJ	280 mm / 11"
1/1 3 x 10 mm	LOVE-GRUEN-WALD	06-06-800BJ	06-06-774BJ	06-06-777BJ	130 mm / 5 1/8"
		06-56-800BJ	06-56-774BJ	06-56-777BJ	150 mm / 6"
		06-06-805BJ	06-06-806BJ	06-06-810BJ	180 mm / 7"
		06-56-805BJ	06-56-811BJ	06-56-810BJ	230 mm / 9"
		06-56-806BJ	06-56-812BJ	06-56-816BJ	280 mm / 11"

Standard Line

 Oberfläche matt gebürstet
 Surface polished

 Beispiel-Artikel-Nr. **06-06-807BJ**
 Example Cat. No.

Black Line

 Oberfläche schwarz, titanbeschichtet
 Surface black, titanium-coated

 Beispiel-Artikel-Nr. **06-06-807BJB**
 Example Cat. No.

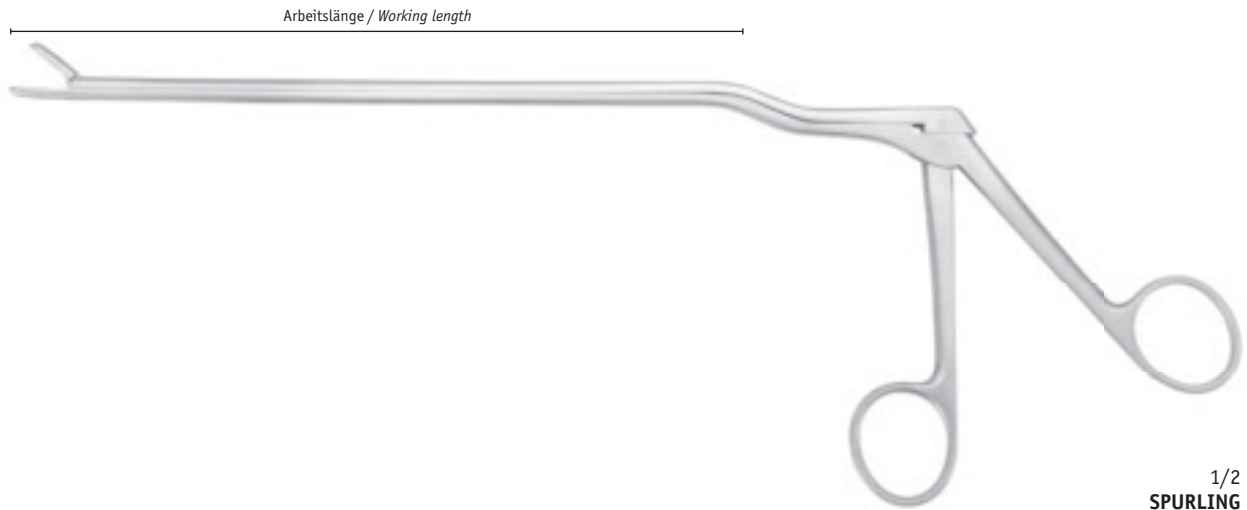

1/2
SPURLING
06-06-807BJ
180 mm
7"



Artikel-Nr. Cat. No.	Artikel-Nr. Cat. No.	Artikel-Nr. Cat. No.	Arbeitslänge Working length		
06-06-801BJ	06-06-775BJ	06-06-778BJ	130 mm / 5 1/8"	SPURLING	1/1 4 x 10 mm
06-56-801BJ	06-56-775BJ	06-56-807BJ	150 mm / 6"		
06-06-807BJ	06-06-814BJ	06-06-811BJ	180 mm / 7"		
06-56-808BJ	06-56-814BJ	06-56-817BJ	230 mm / 9"		
06-56-809BJ	06-56-815BJ	06-56-818BJ	280 mm / 11"		
06-06-767BJ	06-06-776BJ	06-76-823BJ	130 mm / 5 1/8"	CUSHING	1/1 5 x 10 mm
06-76-815BJ	06-76-819BJ	06-76-824BJ	150 mm / 6"		
06-76-816BJ	06-76-820BJ	06-76-825BJ	180 mm / 7"		
06-76-817BJ	06-76-821BJ	06-76-826BJ	230 mm / 9"		
06-76-818BJ	06-76-822BJ	06-76-827BJ	280 mm / 11"		
06-06-768BJ	06-76-832BJ	06-76-837BJ	130 mm / 5 1/8"	CUSHING	1/1 6 x 10 mm
06-76-828BJ	06-76-833BJ	06-76-838BJ	150 mm / 6"		
06-76-829BJ	06-76-834BJ	06-76-839BJ	180 mm / 7"		
06-76-830BJ	06-76-835BJ	06-76-840BJ	230 mm / 9"		
06-76-831BJ	06-76-836BJ	06-76-841BJ	280 mm / 11"		

Standard Line	Black Line
Oberfläche matt gebürstet <i>Surface polished</i> Beispiel-Artikel-Nr. Example Cat. No. 06-06-807BJ	Oberfläche schwarz, titanbeschichtet <i>Surface black, titanium-coated</i> Beispiel-Artikel-Nr. Example Cat. No. 06-06-807BJB

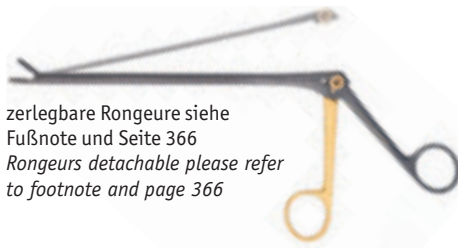





zerlegbare Rongeurs siehe
Fußnote und Seite 366
Rongeurs detachable please refer
to footnote and page 366



1/2
TAKAHASHI
15-11-525
120 mm
4¾"



			Artikel-Nr. Cat. No.	Artikel-Nr. Cat. No.	Artikel-Nr. Cat. No.	Schaftlänge Length of shaft
1/1 2 mm 	BECK	06-06-765				130 mm / 5¼"
1/1 3 mm 	ST. BARTS	15-11-536	15-11-537	15-11-538		115 mm / 4½"
1/1 3 mm 	TAKAHASHI	15-11-525	15-11-526			120 mm / 4¾"
1/1 3 mm 	PENNY- BACKER	06-06-779				120 mm / 4¾"



Standard Line	D E T A C H A B L E
Oberfläche matt gebürstet <i>Surface polished</i> Beispiel-Artikel-Nr. Example Cat. No. 15-11-525	zerlegbar <i>detachable</i> Beispiel-Artikel-Nr. Example Cat. No. 15-11-525DT
Black Line	D E T A C H A B L E
Oberfläche schwarz, titanbeschichtet <i>Surface black, titanium-coated</i> Beispiel-Artikel-Nr. Example Cat. No. 15-11-525B	zerlegbar <i>detachable</i> Beispiel-Artikel-Nr. Example Cat. No. 15-11-525DTB



1/2
WAGNER
06-06-808
210 mm
8¼"

zerlegbare Rongeurs siehe
Fußnote und Seite 366
*Rongeurs detachable please refer
to footnote and page 366*

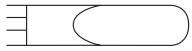
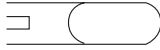

Artikel-Nr. Cat. No.	Artikel-Nr. Cat. No.	Schaftlänge Length of shaft		
14-04-087	14-54-087	255 mm / 10"		1/1 5,3 mm 
06-06-808	06-56-828	210 mm / 8¼"	WAGNER	1/1 5,5 mm 
06-57-057	06-07-057	255 mm / 10"		1/1 5,8 mm 

Standard Line	D E T A C H A B L E
Oberfläche matt gebürstet <i>Surface polished</i> Beispiel-Artikel-Nr. <i>Example Cat. No.</i> 06-06-808	zerlegbar <i>detachable</i> Beispiel-Artikel-Nr. <i>Example Cat. No.</i> 06-06-808DT
Black Line	D E T A C H A B L E
Oberfläche schwarz, titanbeschichtet <i>Surface black, titanium-coated</i> Beispiel-Artikel-Nr. <i>Example Cat. No.</i> 06-06-808B	zerlegbar <i>detachable</i> Beispiel-Artikel-Nr. <i>Example Cat. No.</i> 06-06-808DTB



zerlegbare Rongeurs siehe
Fußnote und Seite 366
Rongeurs detachable please refer
to footnote and page 366



1/2
WEIL-BLAKESLEY
15-11-505
 120 mm
 4¾"



Artikel-Nr.
Cat. No.

Artikel-Nr.
Cat. No.

Schaftlänge
Length of shaft

			Artikel-Nr. Cat. No.	Artikel-Nr. Cat. No.	Schaftlänge Length of shaft
	1/1 2 mm	WEIL-BLAKESLEY	15-61-501	15-61-517	120 mm / 4¾"
	1/1 2,5 mm	WEIL-BLAKESLEY	15-61-502	15-61-518	120 mm / 4¾"
	1/1 3 mm	WEIL-BLAKESLEY	15-11-505	15-61-519	120 mm / 4¾"
	1/1 3,5 mm	WEIL-BLAKESLEY	15-11-506	15-11-520	120 mm / 4¾"
	1/1 4,2 mm	WEIL-BLAKESLEY	15-11-507	15-11-521	120 mm / 4¾"
	1/1 4,8 mm	WEIL-BLAKESLEY	15-11-508	15-11-522	120 mm / 4¾"
	1/1 6 mm	WEIL-BLAKESLEY	15-11-509	15-61-523	120 mm / 4¾"

Standard Line

Oberfläche matt gebürstet
Surface polished

Beispiel-Artikel-Nr.
Example Cat. No. **15-11-505**

D E T A C H A B L E

zerlegbar
detachable

Beispiel-Artikel-Nr.
Example Cat. No. **15-11-505DT**

Black Line

Oberfläche schwarz, titanbeschichtet
Surface black, titanium-coated

Beispiel-Artikel-Nr.
Example Cat. No. **15-11-505B**

D E T A C H A B L E

zerlegbar
detachable

Beispiel-Artikel-Nr.
Example Cat. No. **15-11-505DTB**

zerlegbare Rongeurs siehe
Fußnote und Seite 366
Rongeurs detachable please refer
to footnote and page 366



1/2
SCHLESINGER
15-61-601
130 mm
5 1/8"

Artikel-Nr.
Cat. No.

Schaftlänge
Length of shaft

15-61-601			130 mm / 5 1/8"	SCHLESINGER	1/1 2 x 10 mm	
15-61-598			150 mm / 6"			
15-61-602			130 mm / 5 1/8"	SCHLESINGER	1/1 3 x 10 mm	
15-61-599			150 mm / 6"			
15-61-603			130 mm / 5 1/8"	SCHLESINGER	1/1 4 x 10 mm	
15-61-600			150 mm / 6"			

zerlegbare Rongeurs siehe
Fußnote und Seite 366
Rongeurs detachable please refer
to footnote and page 366



1/2
CLOWARD
15-61-606
150 mm
6"

Artikel-Nr.
Cat. No.

Artikel-Nr.
Cat. No.





Artikel-Nr.
Cat. No.

Schaftlänge
Length of shaft

15-61-605	15-61-608	15-61-611	120 mm / 4 3/4"	CLOWARD	1/1 6 x 10 mm	
15-61-606	15-61-609	15-61-612	150 mm / 6"			
15-61-607	15-61-610	15-61-613	180 mm / 7"			

Standard Line		D E T A C H A B L E					
Oberfläche matt gebürstet Surface polished		zerlegbar detachable					
Beispiel-Artikel-Nr. Example Cat. No.	15-61-601	Beispiel-Artikel-Nr. Example Cat. No. 15-61-601DT					
Black Line		D E T A C H A B L E					
Oberfläche schwarz, titanbeschichtet Surface black, titanium-coated		zerlegbar detachable					
Beispiel-Artikel-Nr. Example Cat. No.	15-61-601B	Beispiel-Artikel-Nr. Example Cat. No. 15-61-601DTB					

 1/2
WILDE
15-61-615
 130 mm
 5 1/8"

		Artikel-Nr. Cat. No.	Artikel-Nr. Cat. No.	Schaftlänge Length of shaft
1/1 3 x 8 mm 	WILDE	15-61-615	15-61-621	130 mm / 5 1/8"
		15-61-616	15-61-622	170 mm / 6 3/4"
1/1 4 x 10 mm 	WILDE	15-61-617	15-61-623	130 mm / 5 1/8"
		15-61-618	15-61-624	170 mm / 6 3/4"
1/1 5 x 12 mm 	WILDE	15-61-619	15-61-625	130 mm / 5 1/8"
		15-61-620	15-61-626	170 mm / 6 3/4"
1/1 6,5 x 12 mm 	HENCKEL-TILLEY	15-11-503		110 mm / 4 3/8"

Standard Line

 Oberfläche matt gebürstet
Surface polished

 Beispiel-Artikel-Nr. **15-61-615**
 Example Cat. No.

Black Line





 Oberfläche schwarz, titanbeschichtet
Surface black, titanium-coated

 Beispiel-Artikel-Nr. **15-61-615B**
 Example Cat. No.



zerlegbare Rongeure siehe
Fußnote und Seite 366
Rongeurs detachable please refer
to footnote and page 366

1/2
OLDBERG
06-06-605
180 mm
7"



Artikel-Nr. Cat. No.	Schaftlänge Length of shaft			
06-06-605	180 mm / 7"	OLDBERG	1/1 Ø 7 mm	
06-06-599	190 mm / 7½"	LANDOLT	1/1 Ø 2,2 mm	
06-06-600	190 mm / 7½"	YASARGIL	1/1 Ø 3,5 mm	
06-06-345	200 mm / 8"	LANDOLT	1/1 Ø 9 mm	

Standard Line	D E T A C H A B L E
Oberfläche matt gebürstet <i>Surface polished</i>	zerlegbar <i>detachable</i>
Beispiel-Artikel-Nr. Example Cat. No. 06-06-605	Beispiel-Artikel-Nr. Example Cat. No. 06-06-605DT
Black Line	D E T A C H A B L E
Oberfläche schwarz, titanbeschichtet <i>Surface black, titanium-coated</i>	zerlegbar <i>detachable</i>
Beispiel-Artikel-Nr. Example Cat. No. 06-06-605B	Beispiel-Artikel-Nr. Example Cat. No. 06-06-605DTB

 1/2
CASPAR
06-06-856
 180 mm
 7"

 Artikel-Nr.
 Cat. No.

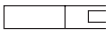
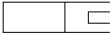
 Schaftlänge
 Length of shaft

1/1 3 mm 	CASPAR	06-06-856	180 mm / 7"
1/1 4 mm 	CASPAR	06-06-857 06-06-858	180 mm / 7" 220 mm / 8¾"
1/1 5,5 mm 	WAGNER	06-06-818	200 mm / 8"

Standard Line

 Oberfläche matt gebürstet
 Surface polished

 Beispiel-Artikel-Nr. **06-06-856**
 Example Cat. No.

Black Line





 Oberfläche schwarz, titanbeschichtet
 Surface black, titanium-coated

 Beispiel-Artikel-Nr. **06-06-856B**
 Example Cat. No.



1/2
**FERRIS-
SMITH**
06-56-880
180 mm
7"



Artikel-Nr. Cat. No.	Artikel-Nr. Cat. No.	Artikel-Nr. Cat. No.	Schaftlänge Length of shaft		
06-56-880	06-56-885	06-56-890	180 mm / 7"	FERRIS- SMITH	1/1 2 x 10 mm 
06-56-881	06-56-886	06-56-891	180 mm / 7"	FERRIS- SMITH	1/1 3 x 10 mm 
06-56-882	06-56-887	06-56-892	180 mm / 7"	FERRIS- SMITH	1/1 4 x 10 mm 
06-56-883	06-56-888	06-56-893	180 mm / 7"	FERRIS- SMITH	1/1 5 x 10 mm 
06-56-884	06-56-889	06-56-894	180 mm / 7"	FERRIS- SMITH	1/1 6 x 10 mm 

Standard Line	Black Line
<p>Oberfläche matt gebürstet <i>Surface polished</i></p> <p>Beispiel-Artikel-Nr. Example Cat. No. 06-56-880</p>	<p>Oberfläche schwarz, titanbeschichtet <i>Surface black, titanium-coated</i></p> <p>Beispiel-Artikel-Nr. Example Cat. No. 06-56-880B</p>



Mikro-Neurochirurgische Instrumente
Micro-Neurosurgical Instruments



HF-Instrumente und Zubehör
HF Instruments and Accessoires



Kopf-Schädelinstrumente und Haltesysteme
Head-Cranio Instruments and Holding Systems



Aneurysmen-Clip System
Aneurysm Clip System



Schädel-Verplattung
Cranial Plate System



Hypophysektomie-Instrumente
Pituitary Instruments



Instrumente für die Wirbelsäule, Wundspreizer
Spine Instruments, Self-retaining Retractors



Laminektomie-Stanzen, Rongeure, Hohlmeißelzangen
Laminectomy Punches, Rongeurs

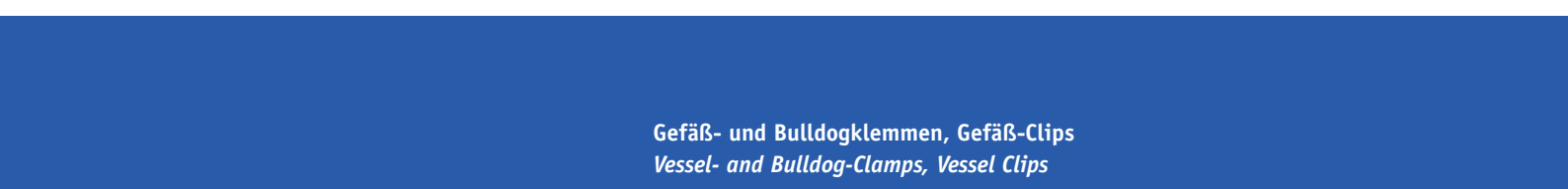

Gefäß- und Bulldogklemmen, Gefäß-Clips
Vessel- and Bulldog-Clamps, Vessel Clips



Allgemeinchirurgische Instrumente
General Surgical Instruments



Alphabetischer Index, Numerischer Index
Alphabetical Index, Numerical Index

/// Gefäß- und Bulldogklemmen, Gefäß-Clips
Vessel- and Bulldog-Clamps, Vessel Clips



REBSTOCK®
Precision made in Germany

SURGICAL
INSTRUMENTS
MICRO-NEURO-SPINE

/// 09

	Einzelklemme <i>Single Clamp</i>	Einzelklemme <i>Single Clamp</i>	Doppelklemme <i>Double Clamp</i>	Approximator <i>Approximator</i>	Approximator <i>Approximator</i>	ACLAND
						
8 mm 0,4 - 1 mm ø Gefäß / vessel	90-80-244 90-80-196	90-80-396 90-80-397	90-80-402 90-80-403	90-80-408 90-80-409	90-80-414 90-80-415	Vene / vein Arterie / artery

	Einzelklemme <i>Single Clamp</i>	Einzelklemme <i>Single Clamp</i>	Doppelklemme <i>Double Clamp</i>	Approximator <i>Approximator</i>	Approximator <i>Approximator</i>	ACLAND
						
11 mm 0,6 - 1,5 mm ø Gefäß / vessel	90-80-245 90-80-197	90-80-398 90-80-399	90-80-404 90-80-405	90-80-410 90-80-411	90-80-416 90-80-417	Vene / vein Arterie / artery

	Einzelklemme <i>Single Clamp</i>	Einzelklemme <i>Single Clamp</i>	Doppelklemme <i>Double Clamp</i>	Approximator <i>Approximator</i>	Approximator <i>Approximator</i>	ACLAND
						
14 mm 1 - 2 mm ø Gefäß / vessel	90-80-500 90-80-501	90-80-502 90-80-503	90-80-504 90-80-505	90-80-506 90-80-507	90-80-508 90-80-509	Vene / vein Arterie / artery

	Einzelklemme <i>Single Clamp</i>	Einzelklemme <i>Single Clamp</i>	Doppelklemme <i>Double Clamp</i>	Approximator <i>Approximator</i>	Approximator <i>Approximator</i>	ACLAND
						
17 mm 1 - 2,25 mm ø Gefäß / vessel	90-80-246 90-80-198	90-80-400 90-80-401	90-80-406 90-80-407	90-80-412 90-80-413	90-80-418 90-80-419	Vene / vein Arterie / artery

Standard Line

 Oberfläche matt gebürstet
Surface polished

 Beispiel-Artikel-Nr. **90-80-412**
 Example Cat. No.

Black Line

 Oberfläche schwarz, titanbeschichtet
Surface black, titanium-coated

 Beispiel-Artikel-Nr. **90-80-412B**
 Example Cat. No.

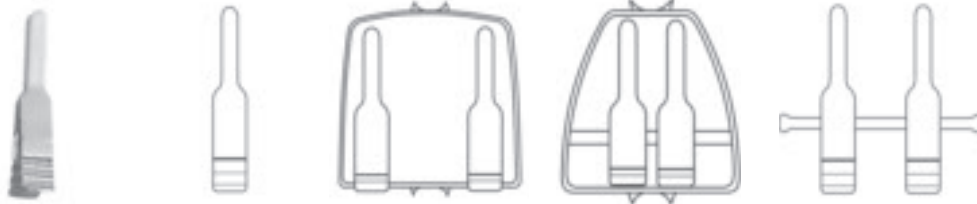

ACLAND

25 mm 1,5 - 3,5 mm Ø Gefäß / vessel	90-80-325	90-80-329	90-80-323	90-80-326	Vene / vein Arterie / artery
	90-80-327	90-80-330	90-80-324	90-80-328	

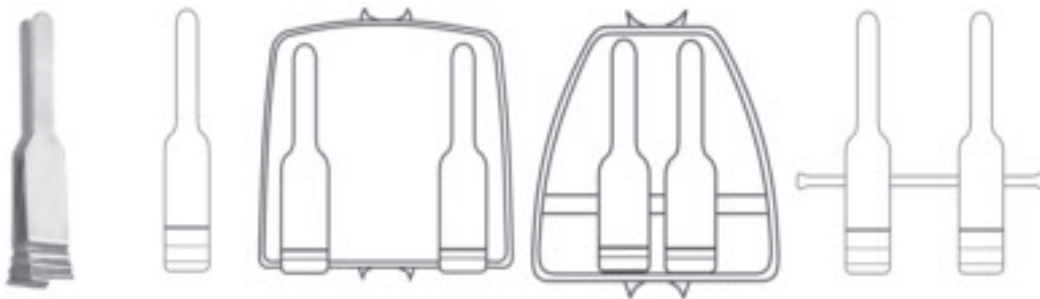

ACLAND

36 mm 2 - 5 mm Ø Gefäß / vessel	90-80-286	90-80-390	90-80-292	90-80-287	Vene / vein Arterie / artery
	90-80-288	90-80-391	90-80-293	90-80-289	

Artikel-Nr.
Cat. No.

Gesamtlänge
Total length

90-80-075	50 x 25 x 4,5 mm		
90-80-076	70 x 45 x 8 mm		
90-80-077	75 x 25 x 4,5 mm		
Lagerungstray für Gefäßklemmen utility tray for storage of vessel clamps			



90-80-075



		Artikel-Nr. Cat. No.	Gesamtlänge Total length
	ACLAND	90-80-071	140 mm / 5½" mit Sperre with ratchet
	ACLAND	90-80-072	140 mm / 5½" ohne Sperre without ratchet

2/3
ACLAND
90-80-072
 140 mm
 5½"



		Artikel-Nr. Cat. No.	Gesamtlänge Total length
		90-80-073	140 mm / 5½" Anlegepinzette zum gleichzeitigen Öffnen beider Klemmen bei Approximatoren und Doppelklemmen applying forceps for opening approximators and double clamps simultaneously

2/3
90-80-073
 140 mm
 5½"

Artikel-Nr. Cat. No.	Gesamtlänge Total length		
06-04-568	145 mm / 5¾"	BIEMER	1/1
	ohne Sperre <i>without ratchet</i>		
06-04-569	145 mm / 5¾"	BIEMER	
	mit Sperre <i>with ratchet</i>		
	für Gefäßclips <i>for vessel clips</i> 06-04-560 - 06-04-562		
	für Approximatoren <i>for approximators</i> 06-04-611 - 06-04-615, 06-04-671 - 06-04-674		

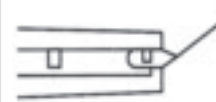
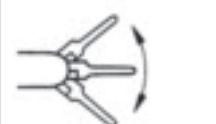

Artikel-Nr. Cat. No.	Gesamtlänge Total length		
06-04-578	145 mm / 5¾"	MEHDORN	1/1
	ohne Sperre <i>without ratchet</i>		
	für Gefäßclips <i>for vessel clips</i> 06-04-552 - 06-04-558		 



1/1
BIEMER
06-04-569
 145 mm
 5¾"

 1/1
 BIEMER-MÜLLER
 06-04-612

		Artikel-Nr. Cat. No.	Schließkraft Closing Force
1/1	BIEMER-MÜLLER	06-04-611	25 - 30 g Maullänge: 9 mm length of jaw: 9 mm
1/1	BIEMER-MÜLLER	06-04-612	25 - 30 g Maullänge: 9 mm length of jaw: 9 mm
1/1	BIEMER-MÜLLER	06-04-613	25 - 30 g Maullänge: 9 mm length of jaw: 9 mm
1/1	BIEMER-MÜLLER	06-04-614	25 - 30 g Maullänge: 9 mm length of jaw: 9 mm
1/1	BIEMER-MÜLLER	06-04-615	25 - 30 g Maullänge: 4,5 mm length of jaw: 4.5 mm





 1/1
 MÜLLER
 06-04-674

		Artikel-Nr. Cat. No.	Schließkraft Closing Force
1/1	MÜLLER	06-04-671	25 - 30 g Maullänge: 9 mm, \varnothing 1 mm length of jaw: 9 mm, \varnothing 1 mm
1/1	MÜLLER	06-04-672	25 - 30 g Maullänge: 9 mm, \varnothing 2 mm length of jaw: 9 mm, \varnothing 2 mm
1/1	MÜLLER	06-04-673	25 - 30 g Maullänge: 9 mm, \varnothing 3 mm length of jaw: 9 mm, \varnothing 3 mm
1/1	MÜLLER	06-04-674	25 - 30 g Maullänge: 9 mm, \varnothing 4 mm length of jaw: 9 mm, \varnothing 4 mm

Artikel-Nr. Cat. No.	Schließkraft Closing Force		
06-04-560	30 - 40 g Maullänge: 6 mm <i>length of jaw: 6 mm</i>	BIEMER	1/1 
06-04-561	30 - 40 g Maullänge: 9 mm <i>length of jaw: 9 mm</i>	BIEMER	1/1 
06-04-562	20 - 25 g Maullänge: 9 mm <i>length of jaw: 9 mm</i>	BIEMER	1/1 



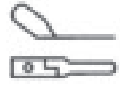





1/1
BIEMER
06-04-561

Artikel-Nr. Cat. No.	Schließkraft Closing Force		
06-04-552	10 - 15 g Maul: 4 x 1 mm <i>jaw: 4 x 1 mm</i>	MEHDORN	1/1 
06-04-554	15 - 20 g Maul: 4 x 1,4 mm <i>jaw: 4 x 1.4 mm</i>	MEHDORN	1/1 
06-04-556	10 - 15 g Maul: 6 x 1 mm <i>jaw: 6 x 1 mm</i>	MEHDORN	1/1 
06-04-558	15 - 20 g Maul: 6 x 1.4 mm <i>jaw: 6 x 1.4 mm</i>	MEHDORN	1/1 

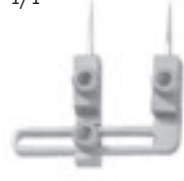

1/1
MEHDORN
06-04-558

Artikel-Nr. Cat. No.			
06-04-570	Approximator <i>approximator</i>	BIEMER	1/1 
06-04-575	Approximator mit Schlüssel 06-04-576 zur individuellen Druckeinstellung <i>approximator with key 06-04-576 for individual pressure adjustment</i>		1/1 
06-04-574	Approximator allein <i>approximator only</i>		
06-04-635	Approximator mit Schlüssel 06-04-576 <i>approximator with key</i>	BIEMER	1/1 
06-04-634	Approximator allein <i>approximator only</i>		
06-04-636	1 Paar Ersatznadeln <i>1 pair of spare needles</i>		
06-04-576	Schlüssel für Approximatoren <i>key for approximators</i> 06-04-574, 06-04-634		1/1 

TITAN
Artikel-Nr.
Cat. No.
Packungsgröße
Packing unit

	1/1 06-52-241	30 à 6 Clips TITAN Clips klein, rot <i>TITANIUM clips</i> small, red
	1/1 06-52-244	30 à 6 Clips TITAN Clips mittel, blau <i>TITANIUM clips</i> medium, blue
	1/1 06-52-245	20 à 6 Clips TITAN Clips mittel-groß, grün <i>TITANIUM clips</i> medium-large, green
	1/1 06-52-247	20 à 6 Clips TITAN Clips groß, orange <i>TITANIUM clips</i> large, orange

Anlegezangen für REBSTOCK TITAN Ligaturclips
Applying Forceps for REBSTOCK TITANIUM Ligating Clips
Artikel-Nr.
Cat. No.
Gesamtlänge
Total length

06-52-200	150 mm / 6"	gebogen / curved
06-52-201	200 mm / 7¾"	gebogen / curved
06-52-202	200 mm / 7¾"	gewinkelt / angled
06-52-203	280 mm / 11"	gebogen / curved
für Clips 06-52-241 (klein, rot) for clips 06-52-241 (small, red)		

06-52-206	150 mm / 6"	gebogen / curved
06-52-207	200 mm / 7¾"	gebogen / curved
06-52-208	200 mm / 7¾"	gewinkelt / angled
06-52-209	280 mm / 11"	gebogen / curved
06-52-216	280 mm / 11"	gewinkelt / angled
für Clips 06-52-244 (mittel, blau) for clips 06-52-244 (medium, blue)		

06-52-220	150 mm / 6"	gebogen / curved
06-52-221	200 mm / 7¾"	gebogen / curved
06-52-226	200 mm / 7¾"	gewinkelt / angled
06-52-227	280 mm / 11"	gebogen / curved
06-52-228	280 mm / 11"	gewinkelt / angled
für Clips 06-52-245 (mittel-groß, grün) for clips 06-52-245 (middle-large, green)		

06-52-230	150 mm / 6"	gebogen / curved
06-52-231	200 mm / 7¾"	gebogen / curved
06-52-232	200 mm / 7¾"	gewinkelt / angled
06-52-233	280 mm / 11"	gebogen / curved
06-52-238	280 mm / 11"	gewinkelt / angled
für Clips 06-52-247 (groß, orange) for clips 06-52-247 (large, orange)		

Anlegezangen für SLS TITAN Ligaturclips
 Applying Forceps for SLS TITANIUM Ligating Clips

Artikel-Nr. Cat. No.	Gesamtlänge Total length	
06-52-210	150 mm / 6"	mikro, weiß micro, white
06-52-211	200 mm / 7¾"	
06-52-212	280 mm / 11"	

06-02-222	150 mm / 6"	klein, gelb small, yellow
06-02-223	200 mm / 7¾"	
06-02-224	280 mm / 11"	

06-52-213	150 mm / 6"	klein-mittel, lila small-medium, purple
06-52-214	200 mm / 7¾"	
06-52-215	280 mm / 11"	

06-02-234	150 mm / 6"	mittel, blau medium, blue
06-02-235	200 mm / 7¾"	
06-02-236	280 mm / 11"	

06-02-240	200 mm / 7¾"	mittel-groß, grün medium-large, green
06-02-242	280 mm / 11"	

06-02-246	200 mm / 7¾"	groß, orange large, orange
06-02-248	280 mm / 11"	



Anlegezangen für ETHICON TITAN Ligaturclips
 Applying Forceps for ETHICON TITANIUM Ligating Clips

Artikel-Nr. Cat. No.	Gesamtlänge Total length		
06-52-222	150 mm / 6"		klein, blau small, blue
06-52-223	200 mm / 7¾"		

06-52-234	150 mm / 6"		mittel, weiß medium, white
06-52-235	200 mm / 7¾"		
06-52-236	280 mm / 11"		

06-52-240	200 mm / 7¾"		mittel-groß, grün middle-large, green
06-52-242	280 mm / 11"		

06-52-246	200 mm / 7¾"	gewinkelt angled	groß, gelb large, yellow
06-52-248	280 mm / 11"	gebogen curved	

 1/1
06-54-681
 6 mm

	Artikel-Nr. Cat. No.	Maullänge Length of jaws
1/1 	06-54-680	4 mm
1/1 	06-54-681	6 mm
1/1 	06-54-682	8 mm
1/1 	06-54-683	10 mm

 1/1
06-54-684
 6 mm

	Artikel-Nr. Cat. No.	Maullänge Length of jaws
1/1 	06-54-684	6 mm leicht gebogen <i>slightly curved</i>
1/1 	06-54-685	6 mm gebogen <i>curved</i>
1/1 	06-54-686	6 mm abgewinkelt 45° <i>angled 45°</i>
1/1 	06-54-687	8 mm seitwärts abgewinkelt 45° <i>angled to side 45°</i>

Artikel-Nr. Cat. No.	Gesamtlänge Total length
06-54-688	140 mm / 5½"
06-54-689	180 mm / 7"
mit Sperre with ratchet	
für Gefäßclips for vessel clips	
06-54-680 - 06-54-687	









1/2
06-54-689
180 mm
7"

Artikel-Nr. Cat. No.	Gesamtlänge Total length
06-54-690	180 mm / 7"
06-54-691	220 mm / 8¾"
mit Sperre with ratchet	
für Gefäßclips for vessel clips	
06-54-680 - 06-54-687	



2/3
06-54-691
180 mm
7"

 1/1
 MÜLLER
 06-05-010

			Artikel-Nr. Cat. No.	Schließkraft Closing Force
	1/1	MÜLLER	06-05-010	50 g
			06-05-020	80 g
	1/1	MÜLLER	06-05-011	50 g
			06-05-021	80 g
	1/1	MÜLLER	06-05-012	50 g
			06-05-022	80 g
	1/1	MÜLLER	06-05-013	50 g
			06-05-023	80 g
	1/1	MÜLLER	06-05-014	50 g
			06-05-024	80 g
	1/1	MÜLLER	06-05-005	Fadenklemme <i>ligature forceps</i>

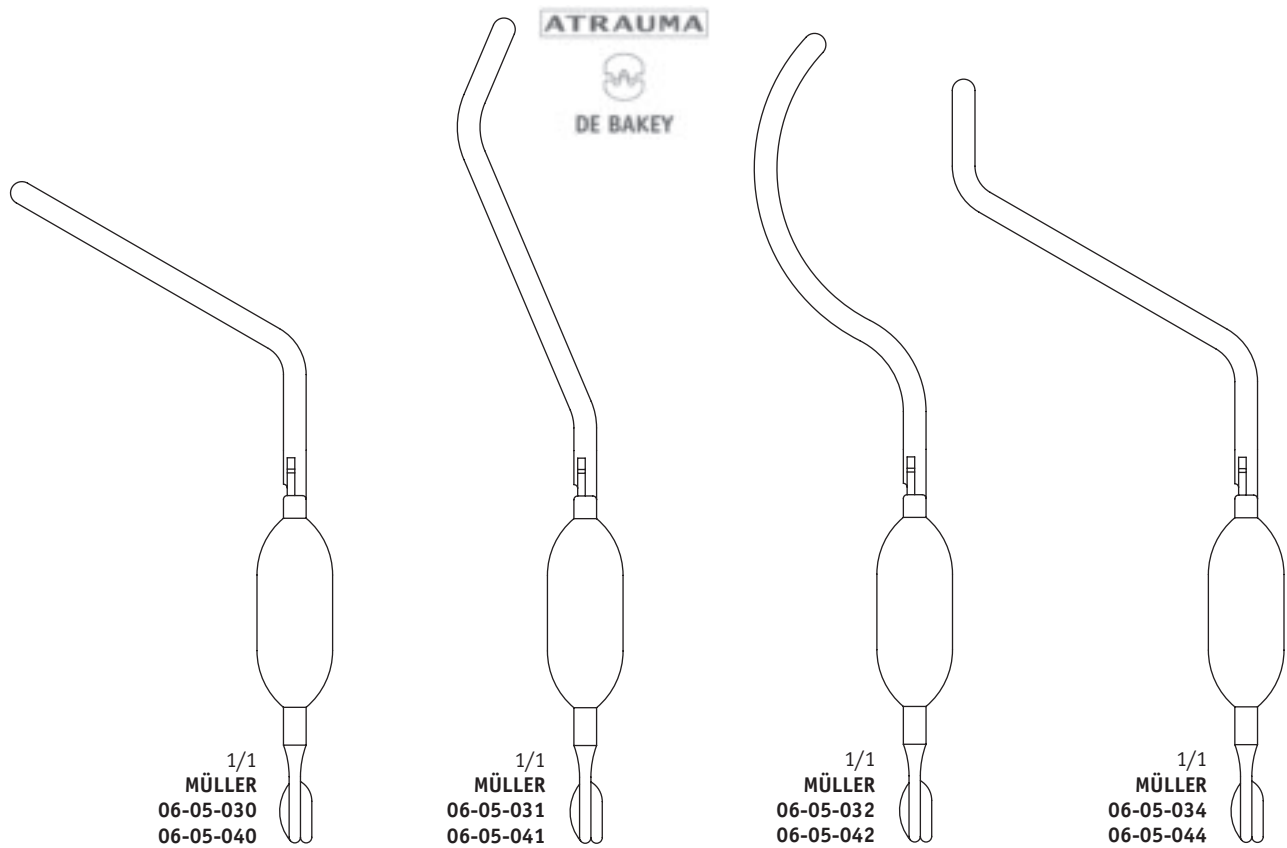



Artikel-Nr. Cat. No.	Schließkraft Closing Force		
06-05-030	250 g	MÜLLER	
06-05-040	350 g		
06-05-031	250 g	MÜLLER	
06-05-041	350 g		
06-05-032	250 g	MÜLLER	
06-05-042	350 g		
06-05-034	250 g	MÜLLER	
06-05-044	350 g		



1/1
MÜLLER
06-05-031





1/1
06-52-351
 35 mm
 1 1/4"

		Artikel-Nr. Cat. No.	Gesamtlänge Total length
1/1 10 mm 		06-52-350	31 mm / 1 1/8" Schließdruck 30 g closing pressure 30 g
1/1 14 mm 		06-52-351	35 mm / 1 1/4" Schließdruck 30 g closing pressure 30 g
1/1 18 mm 		06-52-352	39 mm / 1 1/2" Schließdruck 30 g closing pressure 30 g



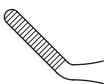
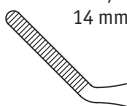
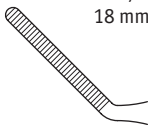

1/1
06-52-354
 35 mm
 1 1/4"

		Artikel-Nr. Cat. No.	Gesamtlänge Total length
1/1 10 mm 		06-52-353	31 mm / 1 1/8" Schließdruck 30 g closing pressure 30 g
1/1 14 mm 		06-52-354	35 mm / 1 1/4" Schließdruck 30 g closing pressure 30 g
1/1 18 mm 		06-52-355	39 mm / 1 1/2" Schließdruck 30 g closing pressure 30 g

Artikel-Nr. Cat. No.	Gesamtlänge Total length		
02-08-020	35 mm / 1½"	DIEFFEN- BACH	1/1
02-08-022	50 mm / 2"		
02-08-021	35 mm / 1½"	DIEFFEN- BACH	1/1
02-08-023	50 mm / 2"		



1/1
DIEFFENBACH
02-08-022
50 mm
2"

Artikel-Nr. Cat. No.	Gesamtlänge Total length		
02-08-026	58 mm / 2¼"	DIEFFEN- BACH	1/1
			
02-08-027	58 mm / 2¼"	DIEFFEN- BACH	1/1
			



1/1
DIEFFENBACH
02-08-026
58 mm
2¼"

ATRAUMA

DE BAKEY

1/1
DE BAKEY-DIETRICH
02-52-202
 60 mm
 2 3/4"

		Artikel-Nr. Cat. No.	Gesamtlänge Total length
1/1	DE BAKEY-DIETRICH	02-52-200	50 mm / 2"
1/1	DE BAKEY-DIETRICH	02-52-201	55 mm / 2 1/8"
1/1	DE BAKEY-DIETRICH	02-52-202	60 mm / 2 3/4"

		Artikel-Nr. Cat. No.	Gesamtlänge Total length
1/1	DE BAKEY-DIETRICH	02-52-203	50 mm / 2"
1/1	DE BAKEY-DIETRICH	02-52-204	55 mm / 2 1/8"
1/1	DE BAKEY-DIETRICH	02-52-205	60 mm / 2 3/4"

		Artikel-Nr. Cat. No.	Gesamtlänge Total length
1/1	DIETRICH	02-52-210	50 mm / 2"
1/1	DIETRICH	02-52-211	55 mm / 2 1/8"
1/1	DIETRICH	02-52-212	60 mm / 2 3/4"

		Artikel-Nr. Cat. No.	Gesamtlänge Total length
1/1	DIETRICH	02-52-213	50 mm / 2"
1/1	DIETRICH	02-52-214	55 mm / 2 1/8"
1/1	DIETRICH	02-52-215	60 mm / 2 3/4"

1/1
DIETRICH
02-52-214
 55 mm
 2 1/8"

Artikel-Nr. Cat. No.	Gesamtlänge Total length		
02-58-012	50 mm / 2"	JOHN-HOPKINS	1/1
02-58-013	55 mm / 2 1/8"		
02-58-014	65 mm / 2 1/2"		
02-58-015	70 mm / 2 3/4"		
02-58-016	75 mm / 3"		
02-58-017	90 mm / 3 1/2"		
02-08-012	50 mm / 2"	JOHN-HOPKINS	1/1
02-08-013	55 mm / 2 1/8"		
02-08-014	65 mm / 2 1/2"		
02-08-015	70 mm / 2 3/4"		
02-08-016	75 mm / 3"		
02-08-017	90 mm / 3 1/2"		



1/1
JOHN-HOPKINS
02-08-013
55 mm
2 1/8"

Artikel-Nr. Cat. No.	Gesamtlänge Total length		
02-08-018	230 mm / 9"		
	Anlege- und Entnahmezange für JOHN HOPKINS Bulldogklemmen		
	<i>applying and removing forceps for JOHN HOPKINS bulldog clamps</i>		



1/3
02-08-018
230 mm
9"



Schließkraft (110 g),
für Venen
closing pressure (110 g),
for veins



Schließkraft (220 g),
für Arterien
closing pressure (220 g),
for arteries



1/1
06-52-304T
40 mm
1½"





1/1
06-52-314T
40 mm
1½"



1/1
06-52-324T
40 mm
1½"

TITAN

	Artikel-Nr. Cat. No.		Gesamtlänge Total length
1/1	06-52-300T	Vene vein	30 mm / 1½"
	06-52-301T	Arterie artery	
1/1	06-52-302T	Vene vein	35 mm / 1¾"
	06-52-303T	Arterie artery	
1/1	06-52-304T	Vene vein	40 mm / 1½"
	06-52-305T	Arterie artery	
1/1	06-52-306T	Vene vein	50 mm / 2"
	06-52-307T	Arterie artery	
1/1	06-52-310T	Vene vein	30 mm / 1½"
	06-52-311T	Arterie artery	
1/1	06-52-312T	Vene vein	35 mm / 1¾"
	06-52-313T	Arterie artery	
1/1	06-52-314T	Vene vein	40 mm / 1½"
	06-52-315T	Arterie artery	
1/1	06-52-316T	Vene vein	50 mm / 2"
	06-52-317T	Arterie artery	
1/1	06-52-320T	Vene vein	30 mm / 1½"
	06-52-321T	Arterie artery	
1/1	06-52-322T	Vene vein	35 mm / 1¾"
	06-52-323T	Arterie artery	
1/1	06-52-324T	Vene vein	40 mm / 1½"
	06-52-325T	Arterie artery	
1/1	06-52-326T	Vene vein	50 mm / 2"
	06-52-327T	Arterie artery	

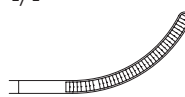
Artikel-Nr. Cat. No.	Gesamtlänge Total length		
06-02-328	45 mm / 1¾"		1/1 
06-02-329	45 mm / 1¾"		1/1 
06-02-330	50 mm / 2"		1/1 
06-02-331	50 mm / 2"		1/1 



1/1
06-02-328
45 mm
1¾"

mit Rändelschraube zur individuellen Druckeinstellung
with knurled screw for individual pressure adjustment



Artikel-Nr. Cat. No.	Gesamtlänge Total length		
06-02-352	50 mm / 2"	DE BAKEY	1/1 
06-02-353	50 mm / 2"	DE BAKEY	1/1 







1/1
06-02-353
50 mm
2"

mit Rändelschraube zur individuellen Druckeinstellung
with knurled screw for individual pressure adjustment











1/1
06-02-422
90 mm
3½"

		Artikel-Nr. Cat. No.	Gesamtlänge Total length
	20 mm DE BAKEY	06-02-420	80 mm / 3½"
	30 mm DE BAKEY	06-02-422	90 mm / 3½"
	45 mm DE BAKEY	06-02-424	105 mm / 4¼"
	68 mm DE BAKEY	06-02-426	125 mm / 5"



1/1
06-02-423
85 mm
3½"

		Artikel-Nr. Cat. No.	Gesamtlänge Total length
	20 mm DE BAKEY	06-02-421	75 mm / 3"
	30 mm DE BAKEY	06-02-423	85 mm / 3½"
	45 mm DE BAKEY	06-02-425	95 mm / 3¾"
	68 mm DE BAKEY	06-02-427	115 mm / 4½"



Artikel-Nr. Cat. No.	Gesamtlänge Total length		
06-52-358	90 mm / 3½"	GREGORY- „SOFT“	27 mm 
06-52-359	110 mm / 4¼"	GREGORY- „SOFT“	44 mm 
06-52-360	90 mm / 3½"	GREGORY- „SOFT“	41 mm 
06-52-361	110 mm / 4¼"	GREGORY- „SOFT“	60 mm 

ATRAUMA



DE BAKEY



Artikel-Nr. Cat. No.	Gesamtlänge Total length		
06-52-363	110 mm / 4¼" links left	GREGORY- „SOFT“	60 mm 
06-52-362	110 mm / 4¼" rechts right	GREGORY- „SOFT“	60 mm 

1/2
GREGORY „SOFT“
06-52-361
110 mm
4¼"

ATRAUMA



DE BAKEY



Artikel-Nr. Cat. No.	Gesamtlänge Total length		
06-52-364	70 mm / 2¾"	SANTULLI	30 mm 

1/2
SANTULLI
06-52-364
70 mm
2¾"



1/1
COOLEY
06-52-368
90 mm
3½"

			Artikel-Nr. Cat. No.	Gesamtlänge Total length
	20 mm	COOLEY	06-52-366	80 mm / 3⅛"
	30 mm	COOLEY	06-52-368	90 mm / 3½"
	45 mm	COOLEY	06-52-370	105 mm / 4¼"
	68 mm	COOLEY	06-52-372	125 mm / 5"

			Artikel-Nr. Cat. No.	Gesamtlänge Total length
	20 mm	COOLEY	06-52-367	75 mm / 3"
	30 mm	COOLEY	06-52-369	85 mm / 3½"
	45 mm	COOLEY	06-52-371	95 mm / 3¾"
	68 mm	COOLEY	06-52-373	115 mm / 4½"

Artikel-Nr. Cat. No.	Gesamtlänge Total length	SHUNT	
06-52-380	75 mm / 3" ø 10 Fr.		
06-52-381	ø 12 Fr.		
06-52-382	ø 14 Fr.		



Artikel-Nr. Cat. No.	Gesamtlänge Total length	SHUNT	
06-52-383	75 mm / 3" ø 10 Fr.		
06-52-384	ø 12 Fr.		
06-52-385	ø 14 Fr.		



1/1
SHUNT
06-52-381
75 mm
3"

1/1
SHUNT
06-52-384
75 mm
3"

Artikel-Nr. Cat. No.	Gesamtlänge Total length	SHUNT	
06-52-386	75 mm / 3" ø 10 Fr.		
06-52-387	ø 12 Fr.		
06-52-388	ø 14 Fr.		



1/1
SHUNT
06-52-387
75 mm
3"

Artikel-Nr. Cat. No.	Gesamtlänge Total length	SHUNT	
06-52-389	75 mm / 3" ø 10 Fr.		
06-52-390	ø 12 Fr.		
06-52-391	ø 14 Fr.		



1/1
SHUNT
06-52-390
75 mm
3"

ATRAUMA

DE BAKEY

 1/1
GLOVER
06-02-432
 80 mm
 3 1/8"

			Artikel-Nr. Cat. No.	Gesamtlänge Total length
	20 mm	GLOVER	06-52-430	70 mm / 2 3/4"
	30 mm	GLOVER	06-02-432	80 mm / 3 1/8"
	43 mm	GLOVER	06-02-434	95 mm / 3 3/4"
	56 mm	GLOVER	06-02-436	115 mm / 4 1/2"

 mit Rändelschraube zur individuellen Druckeinstellung
 with knurled screw for individual pressure adjustment



ATRAUMA

DE BAKEY

 1/1
GLOVER
06-02-433
 75 mm
 2 3/4"

			Artikel-Nr. Cat. No.	Gesamtlänge Total length
	20 mm	GLOVER	06-52-431	65 mm / 2 1/2"
	30 mm	GLOVER	06-02-433	75 mm / 3"
	43 mm	GLOVER	06-02-435	85 mm / 3 1/2"
	56 mm	GLOVER	06-02-437	105 mm / 4 1/4"

 mit Rändelschraube zur individuellen Druckeinstellung
 with knurled screw for individual pressure adjustment

Artikel-Nr. Cat. No.	Gesamtlänge Total length		
06-02-357	70 mm / 2¾"	DE BAKEY	1/1 
06-02-359	95 mm / 3¾"	DE BAKEY	1/1 
06-02-358	100 mm / 4"	DE BAKEY	1/1 

mit Rändelschraube zur individuellen Druckeinstellung
with knurled screw for individual pressure adjustment

ATRAUMA



DE BAKEY



1/1
DE BAKEY
06-02-357
70 mm
2¾"

Artikel-Nr. Cat. No.	Gesamtlänge Total length		
06-02-431	55 mm / 2¼"	GLOVER	27 mm 

mit Rändelschraube zur individuellen Druckeinstellung
with knurled screw for individual pressure adjustment

ATRAUMA



DE BAKEY



1/1
GLOVER
06-02-431
55 mm
2¼"



Mikro-Neurochirurgische Instrumente
Micro-Neurosurgical Instruments

HF-Instrumente und Zubehör
HF Instruments and Accessoires

Kopf-Schädelinstrumente und Haltesysteme
Head-Cranio Instruments and Holding Systems

Aneurysmen-Clip System
Aneurysm Clip System

Schädel-Verplattung
Cranial Plate System

Hypophysektomie-Instrumente
Pituitary Instruments

Instrumente für die Wirbelsäule, Wundspreizer
Spine Instruments, Self-retaining Retractors

Laminektomie-Stanzen, Rongeure, Hohlmeißelzangen
Laminectomy Punches, Rongeurs

Gefäß- und Bulldogklemmen, Gefäß-Clips
Vessel- and Bulldog-Clamps, Vessel Clips

Allgemeinchirurgische Instrumente
General Surgical Instruments



Alphabetischer Index, Numerischer Index
Alphabetical Index, Numerical Index

/// Allgemein chirurgische Instrumente
General Surgical Instruments



REBSTOCK®
Precision made in Germany

SURGICAL
INSTRUMENTS
MICRO-NEURO-SPINE

/// 10



**Gr.
3**

Skalpellgriffe, passend für auswechselbare Skalpellklingen Fig. 10, 11, 12, 13, 15
scalpel handles for scalpel blades fig. 10, 11, 12, 13, 15



1/2
02-02-073
125 mm
4¾"

Artikel-Nr. Cat. No.	Gesamtlänge Total length
02-02-073	125 mm / 4¾"
	No. 3
02-02-074	125 mm / 4¾"
	No. 3 mit Zentimeter-Graduierung cm graduation



1/2
02-02-075
210 mm
8½"

Artikel-Nr. Cat. No.	Gesamtlänge Total length
02-02-075	210 mm / 8½"
	No. 3L



1/2
02-52-075
210 mm
8½"

Artikel-Nr. Cat. No.	Gesamtlänge Total length
02-52-075	210 mm / 8½"
	No. 3L abgewinkelt angled

1/1



Skalpellsgriffe, passend für auswechselbare Skalpellsklingen Fig. 10, 11, 12, 13, 15
scalpel handles for scalpel blades fig. 10, 11, 12, 13, 15

**Gr.
3**

Artikel-Nr. Cat. No.	Gesamtlänge Total length		
02-52-078	160 mm / 6¼"		
No. 5			

1/2
02-52-078
160 mm
6¼"



Artikel-Nr. Cat. No.	Gesamtlänge Total length		
02-02-078	215 mm / 8½"		
No. 5			

1/2
02-02-078
215 mm
8½"



Artikel-Nr. Cat. No.	Gesamtlänge Total length		
02-02-079	210 mm / 8¼"		1/1
No. 5 abgewinkelt angled			

1/2
02-02-079
210 mm
8¼"



**Gr.
3**

 Skalpelli, passend für auswechselbare Skalpellklingen Fig. 10, 11, 12, 13, 15
 scalpel handles for scalpel blades fig. 10, 11, 12, 13, 15

 1/2
02-02-077
 160 mm
 6¼"

		Artikel-Nr. Cat. No.	Gesamtlänge Total length
		02-02-077	160 mm / 6¼"
			No. 7

 1/2
02-52-077
 125 mm
 5"

		Artikel-Nr. Cat. No.	Gesamtlänge Total length
		02-52-077	125 mm / 5"
			No. 7K

 1/2
02-52-079
 220 mm
 8¾"

		Artikel-Nr. Cat. No.	Gesamtlänge Total length
		02-52-079	220 mm / 8¾"
			No. 7L



10

Skalpellgriffe, passend für auswechselbare Skalpellklingen Fig. 10, 11, 12, 13, 15
scalpel handles for scalpel blades fig. 10, 11, 12, 13, 15

Artikel-Nr. Cat. No.	Gesamtlänge Total length		
02-02-063	145 mm / 5¾"	No. 3R	



Gr.
3

1/2
02-02-063
145 mm
5¾"

Artikel-Nr. Cat. No.	Gesamtlänge Total length		
02-52-063	140 mm / 5⅔"	No. 3R	1/1 



1/2
02-52-063
140 mm
5⅔"

Artikel-Nr. Cat. No.			
02-52-060	Skalpellklingen-Entferner scalpel blade remover		



1/1
02-52-060

Gr.
4

 Skalpellgriffe, passend für auswechselbare Skalpellklingen Fig. 18, 19, 20, 21, 22, 23, 24, 25, 34, 36
scalpel handles for scalpel blades fig. 18, 19, 20, 21, 22, 23, 24, 25, 34, 36

 1/2
02-02-084
 135 mm
 5¼"

Artikel-Nr.
Cat. No.
Gesamtlänge
Total length

Artikel-Nr. Cat. No.	Gesamtlänge Total length
02-02-084	135 mm / 5¼"
02-52-084	135 mm / 5¼" No. 4 mit Zentimeter-Graduierung <i>cm graduation</i>

 1/2
02-02-085
 210 mm
 8¼"

Artikel-Nr.
Cat. No.
Gesamtlänge
Total length

Artikel-Nr. Cat. No.	Gesamtlänge Total length
02-02-085	210 mm / 8¼" No. 4L

10

Skalpellgriffe, passend für auswechselbare Skalpellklingen Fig. 18, 19, 20, 21, 22, 23, 24, 25, 34, 36
scalpel handles for scalpel blades fig. 18, 19, 20, 21, 22, 23, 24, 25, 34, 36

**Gr.
4**

Artikel-Nr. Cat. No.	Gesamtlänge Total length		
02-52-085	210 mm / 8¼"		1/1
	No. 4L abgewinkelt angled		



1/2
02-52-085
210 mm
8¼"



TC



1/2
02-03-110
110 mm
4 3/8"

		Artikel-Nr. Cat. No.	Artikel-Nr. Cat. No.	Gesamtlänge Total length
1/1	IRIS	02-03-100	02-03-210	90 mm / 3 1/2"
		02-03-056		95 mm / 3 3/4"
		02-03-060		105 mm / 4 1/4"
		02-03-110		110 mm / 4 3/8"
		02-03-106		115 mm / 4 1/2"
		02-03-064		120 mm / 4 3/4"
spitz / spitz sharp / sharp				
1/1	IRIS	02-03-101	02-03-211	90 mm / 3 1/2"
		02-03-057		95 mm / 3 3/4"
		02-03-061		105 mm / 4 1/4"
		02-03-111		110 mm / 4 3/8"
		02-03-107		115 mm / 4 1/2"
		02-03-065		120 mm / 4 3/4"
spitz / spitz sharp / sharp				
1/1		02-03-112		110 mm / 4 3/8"
		02-03-113		110 mm / 4 3/8"
spitz / stumpf sharp / blunt				
1/1		02-03-117		110 mm / 4 3/8"
seitwärts gebogen curved to side				



1/2
IRIS SUPERCUT
02-03-900
110 mm
4 3/8"

		Artikel-Nr. Cat. No.	Gesamtlänge Total length
1/1	IRIS Supercut	02-03-900	110 mm / 4 3/8"
1/1	IRIS Supercut	02-03-901	110 mm / 4 3/8"

Artikel-Nr. Cat. No.	Gesamtlänge Total length		
02-03-117	110 mm / 4 ³ / ₈ "	IRIS	

2/3
IRIS
02-03-117
110 mm
4³/₈"



Artikel-Nr. Cat. No.	Gesamtlänge Total length		
02-53-032	115 mm / 4 ¹ / ₂ "	IRIS	

2/3
IRIS
02-53-032
115 mm
4¹/₂"



Artikel-Nr. Cat. No.	Gesamtlänge Total length		
02-03-033	115 mm / 4 ¹ / ₂ "	IRIS	

2/3
IRIS
02-03-033
115 mm
4¹/₂"





2/3
PERWITZCHKY
02-03-030
115 mm
4½"

		Artikel-Nr. Cat. No.	Gesamtlänge Total length
	PER- WITZCHKY	02-03-030	115 mm / 4½" mit Knopf with probe



2/3
PERWITZCHKY
15-13-489
100 mm
4"

		Artikel-Nr. Cat. No.	Gesamtlänge Total length
	PER- WITZCHKY	15-13-489	100 mm / 4" mit Knopf with probe



1/2
SANVENERO
02-53-126
140 mm
5½"

		Artikel-Nr. Cat. No.	Gesamtlänge Total length
1/1	SANVENERO	02-53-126	140 mm / 5½"
1/1	SANVENERO	02-53-127	140 mm / 5½"

Artikel-Nr. Cat. No.	Gesamtlänge Total length		
02-03-156	140 mm / 5½"	JOSEPH	1/1
02-03-157	140 mm / 5½"	JOSEPH	1/1





1/2
JOSEPH
02-03-156
140 mm
5½"

Artikel-Nr. Cat. No.	Gesamtlänge Total length		
02-03-916	140 mm / 5½"	JOSEPH Supercut	1/1
02-03-917	140 mm / 5½"	JOSEPH Supercut	1/1





1/2
JOSEPH
Supercut
02-03-916
140 mm
5½"

 1/2
02-53-670
 150 mm
 6"

		Artikel-Nr. Cat. No.	Gesamtlänge Total length
1/1		02-53-670	150 mm / 6"
1/1		02-03-628	150 mm / 6"

 1/2
KELLY
02-03-160
 175 mm
 7"

		Artikel-Nr. Cat. No.	Gesamtlänge Total length
1/1	KELLY 	02-03-160	175 mm / 7"
1/1	KELLY 	02-03-161	175 mm / 7"

TC

Artikel-Nr. Cat. No.	Artikel-Nr. Cat. No.	Gesamtlänge Total length		
02-53-340		105 mm / 4¼"	STANDARD	1/1
02-03-341		115 mm / 4½"		
02-03-343		130 mm / 5"		
02-03-344		145 mm / 5¾"		
02-03-345	02-03-228	150 mm / 6"		
02-03-346	02-53-200	165 mm / 6½"		
02-53-347		175 mm / 7"		
02-53-348	02-53-202	185 mm / 7¼"		
02-53-349		200 mm / 8"		
02-53-440		105 mm / 4¼"		
02-03-441		115 mm / 4½"		
02-03-443		130 mm / 5"		
02-03-444		145 mm / 5¾"		
02-03-445	02-53-199	150 mm / 6"		
02-03-446	02-53-201	165 mm / 6½"		
02-53-447		175 mm / 7"		
02-53-448	02-53-203	185 mm / 7¼"		
02-53-449		200 mm / 8"		



1/2
02-03-346
165 mm
6½"

TC

Artikel-Nr. Cat. No.	Artikel-Nr. Cat. No.	Gesamtlänge Total length		
02-53-080		105 mm / 4¼"	STANDARD Supercut	1/1
02-53-081		115 mm / 4½"		
02-53-082		130 mm / 5"		
02-53-083	02-53-096	145 mm / 5¾"		
02-53-084		150 mm / 6"		
02-53-085	02-53-097	165 mm / 6½"		
02-53-086		185 mm / 7¼"		
02-53-087		200 mm / 8"		
02-53-088		105 mm / 4¼"	STANDARD Supercut	1/1
02-53-089		115 mm / 4½"		
02-53-090		130 mm / 5"		
02-53-091	02-53-098	145 mm / 5¾"		
02-53-092		150 mm / 6"		
02-53-093	02-53-099	165 mm / 6½"		
02-53-094		185 mm / 7¼"		
02-53-095		200 mm / 8"		



1/2
Supercut
02-03-346
165 mm
6½"

TC

 1/2
02-03-326
 165 mm
 6½"

		Artikel-Nr. Cat. No.	Artikel-Nr. Cat. No.	Gesamtlänge Total length
1/1	STANDARD	02-03-320		105 mm / 4¼"
		02-03-321		115 mm / 4½"
		02-03-323		130 mm / 5"
		02-03-324		145 mm / 5¾"
		02-03-325	02-03-224	150 mm / 6"
		02-03-326	02-53-206	165 mm / 6½"
		02-03-327		175 mm / 7"
		02-03-328	02-53-208	185 mm / 7¼"
		02-03-330		200 mm / 8"
		1/1	STANDARD	02-53-420
02-03-421				115 mm / 4½"
02-03-423				130 mm / 5"
02-03-424				145 mm / 5¾"
02-03-425	02-03-234			150 mm / 6"
02-03-426	02-53-207			165 mm / 6½"
02-03-427				175 mm / 7"
02-53-428	02-53-209			185 mm / 7¼"
02-53-429				200 mm / 8"

 1/2
Supercut
02-53-064
 165 mm
 6½"

		Artikel-Nr. Cat. No.	Artikel-Nr. Cat. No.	Gesamtlänge Total length
1/1	STANDARD Supercut	02-53-060		115 mm / 4½"
		02-53-061		130 mm / 5"
		02-53-062	02-53-074	145 mm / 5¾"
		02-53-063		150 mm / 6"
		02-53-064	02-53-075	165 mm / 6½"
		02-53-065		185 mm / 7¼"
		02-53-066		200 mm / 8"
1/1	STANDARD Supercut	02-53-067		115 mm / 4½"
		02-53-068		130 mm / 5"
		02-53-069	02-53-076	145 mm / 5¾"
		02-53-070		150 mm / 6"
		02-53-071	02-53-077	165 mm / 6½"
		02-53-072		185 mm / 7¼"
		02-53-073		200 mm / 8"

TC

Artikel-Nr. Cat. No.	Artikel-Nr. Cat. No.	Gesamtlänge Total length		
02-53-311		105 mm / 4¼"	STANDARD	1/1
02-53-312		115 mm / 4½"		
02-03-313		130 mm / 5"		
02-03-314		145 mm / 5¾"		
02-03-315	02-53-230	150 mm / 6"		
02-03-316	02-53-232	165 mm / 6½"		
02-03-317		175 mm / 7"		
02-53-318	02-53-234	185 mm / 7¼"		
02-53-319		200 mm / 8"		
02-53-410		105 mm / 4¼"		
02-03-411		115 mm / 4½"		
02-03-413		130 mm / 5"		
02-03-414		145 mm / 5¾"		
02-03-415	02-03-231	150 mm / 6"		
02-03-416	02-53-233	165 mm / 6½"		
02-03-417		175 mm / 7"		
02-53-418	02-53-235	185 mm / 7¼"		
02-53-419		200 mm / 8"		



1/2
02-03-316
165 mm
6½"

TC



Artikel-Nr. Cat. No.	Artikel-Nr. Cat. No.	Gesamtlänge Total length				
02-53-040		105 mm / 4¼"	STANDARD Supercut	1/1		
02-53-041		115 mm / 4½"				
02-53-042		130 mm / 5"				
02-53-043	02-53-056	145 mm / 5¾"				
02-53-044		150 mm / 6"				
02-53-045	02-53-057	165 mm / 6½"				
02-53-046		185 mm / 7¼"				
02-53-047		200 mm / 8"				
02-53-048		105 mm / 4¼"			STANDARD Supercut	1/1
02-53-049		115 mm / 4½"				
02-53-050		130 mm / 5"				
02-53-051	02-53-058	145 mm / 5¾"				
02-53-052		150 mm / 6"				
02-53-053	02-53-059	165 mm / 6½"				
02-53-054		185 mm / 7¼"				
02-53-055		200 mm / 8"				



1/2
Supercut
02-53-045
165 mm
6½"





1/2
DEAVER
02-03-374
145 mm
5¾"

		TC		
		Artikel-Nr. Cat. No.	Artikel-Nr. Cat. No.	Gesamtlänge Total length
1/1	DEAVER	02-03-374	02-53-374	145 mm / 5¾"
				
1/1	DEAVER	02-03-474	02-53-474	145 mm / 5¾"
				



1/2
DEAVER
02-53-568
145 mm
5¾"

		TC		
		Artikel-Nr. Cat. No.	Artikel-Nr. Cat. No.	Gesamtlänge Total length
1/1	DEAVER	02-53-568	02-53-472	145 mm / 5¾"
				
1/1	DEAVER	02-03-464	02-53-473	145 mm / 5¾"
				

Artikel-Nr. Cat. No.	Gesamtlänge Total length		
02-03-503	130 mm / 5 1/8"		
	Inzisions-Scheren <i>incision scissors</i>		
02-03-504	145 mm / 5 3/4"		
	Inzisions-Scheren <i>incision scissors</i>		



1/2
02-03-503
130 mm
5 1/8"

Artikel-Nr. Cat. No.	Gesamtlänge Total length		
02-53-470	150 mm / 6"	KAYE FACE LIFT Supercut	1/1
02-53-471	190 mm / 7 1/2"		



1/2
KAYE FACE LIFT
Supercut
02-53-471
190 mm
7 1/2"











1/2
STEVENS
02-03-186
 100 mm
 4"

		Artikel-Nr. Cat. No.	Gesamtlänge Total length
1/1	STEVENS	02-03-186	100 mm / 4" Gefäß- und Sehnenschere vessel and tendon scissors
1/1	STEVENS	02-03-187	100 mm / 4" Gefäß- und Sehnenschere vessel and tendon scissors
1/1	STEVENS	15-11-366	100 mm / 4" Gefäß- und Sehnenschere, fein vessel and tendon scissors, delicate





1/2
COTTLE-MASING
15-11-365
 105 mm
 4 1/8"

		Artikel-Nr. Cat. No.	Gesamtlänge Total length
1/1	COTTLE-MASING	15-11-365	105 mm / 4 1/8" scharf sharp
1/1	COTTLE-MASING	15-11-367	105 mm / 4 1/8" stumpf blunt

Artikel-Nr. Cat. No.	Gesamtlänge Total length		
02-03-170	110 mm / 4 ³ / ₈ "	STEVENS	1/1 
02-03-171	110 mm / 4 ³ / ₈ "	STEVENS	1/1 
02-03-172	110 mm / 4 ³ / ₈ "	STEVENS	1/1 
02-03-173	110 mm / 4 ³ / ₈ "	STEVENS	1/1 
02-03-194	125 mm / 5"	STEVENS	1/1 
02-03-195	125 mm / 5"	STEVENS	1/1 



1/2
STEVENS
02-03-170
110 mm
4³/₈"

Artikel-Nr. Cat. No.	Gesamtlänge Total length		
02-53-452	110 mm / 4 ³ / ₈ "	STEVENS Supercut	1/1 
02-53-453	110 mm / 4 ³ / ₈ "	STEVENS Supercut	1/1 



1/2
STEVENS
Supercut
02-53-452
110 mm
4³/₈"



1/2
COTTLE
15-11-374
 115 mm
 4½"



		Artikel-Nr. Cat. No.	Gesamtlänge Total length
1/1	COTTLE	15-11-374	115 mm / 4½"



1/2
02-03-164
 115 mm
 4½"

		Artikel-Nr. Cat. No.	Gesamtlänge Total length
1/1	KILNER	02-03-162	115 mm / 4½" spitz sharp
1/1	LITTLER	02-03-163	115 mm / 4½" mit Fadenbohrung in der Spitze tips with eye for suture
1/1		02-03-164	115 mm / 4½" stumpf blunt
1/1		02-03-165	115 mm / 4½" stumpf blunt



Artikel-Nr. Cat. No.	Gesamtlänge Total length		
15-11-368	105 mm / 4 1/8"	COTTLE-KNAPP	1/1
			
15-11-369	105 mm / 4 1/8"	COTTLE-KNAPP	1/1
			

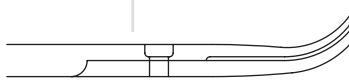
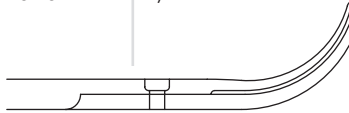

1/2
COTTLE-KNAPP
15-11-368
105 mm
4 1/8"

Artikel-Nr. Cat. No.	Gesamtlänge Total length		
15-11-373	115 mm / 4 1/2"	FOMON	1/1
			
15-11-372	135 mm / 5 1/4"	FOMON	1/1
			



1/2
FOMON
15-11-373
115 mm
4 1/2"





1/2
KILNER
02-03-168
150 mm
6"



1/1

KILNER

Artikel-Nr.
Cat. No.

02-03-166

02-03-168

TC

Artikel-Nr.
Cat. No.

02-53-266

02-53-268

Gesamtlänge
Total length

125 mm / 5"

150 mm / 6"



1/2
REYNOLDS
02-53-178
145 mm
5¾"

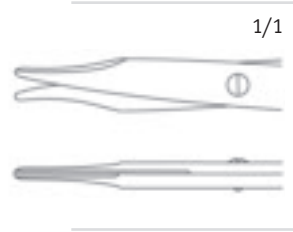

1/1

REYNOLDS

Artikel-Nr.
Cat. No.

02-53-178

TC

Artikel-Nr.
Cat. No.

02-53-179

Gesamtlänge
Total length

145 mm / 5¾"

1/1

REYNOLDS

Artikel-Nr.
Cat. No.

02-03-180

02-03-181



Artikel-Nr.
Cat. No.

02-53-180

Gesamtlänge
Total length



175 mm / 7"



Artikel-Nr. Cat. No.	Gesamtlänge Total length		
02-03-184	125 mm / 5"	GORNEY	1/1
	gezahnt toothed		
02-03-188	195 mm / 7¾"	GORNEY	1/1
	gezahnt toothed		
02-03-189	195 mm / 7¾"	GORNEY	1/1
	gezahnt toothed		



1/2
GORNEY
02-03-188
195 mm
7¾"

Artikel-Nr. Cat. No.	Gesamtlänge Total length		
02-03-920	195 mm / 7¾"	GORNEY Supercut	1/1
			
02-03-921	195 mm / 7¾"	GORNEY Supercut	1/1
			



1/2
GORNEY
Supercut
02-03-920
195 mm
7¾"







1/2
LANDOLT
15-03-430
 120 mm
 4¾"

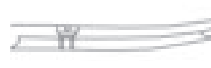

		Artikel-Nr. Cat. No.	Gesamtlänge Total length
1/1	LANDOLT	15-03-430	120 mm / 4¾"
1/1	LANDOLT	15-03-431	120 mm / 4¾"



Artikel-Nr. Cat. No.	Gesamtlänge Total length		
02-03-175	130 mm / 5 1/8"	JAMESON- WERBER	1/1 
02-03-177	150 mm / 6"	JAMESON	1/1 



1/2
JAMESON
02-03-177
150 mm
6"

Artikel-Nr. Cat. No.	Gesamtlänge Total length		
02-03-911	130 mm / 5 1/8"	JAMESON Supercut	1/1 
02-03-915	150 mm / 6"	JAMESON Supercut	1/1 



1/2
JAMESON
Supercut
02-03-915
150 mm
6"







1/2
TOENNIS
02-03-633
 180 mm
 7"

		Artikel-Nr. Cat. No.	Gesamtlänge Total length
1/1	TOENNIS	02-03-633	180 mm / 7" sehr fein <i>very delicate</i>
1/1	TOENNIS	02-03-634	180 mm / 7" fein <i>delicate</i>
1/1	TOENNIS	02-03-635	180 mm / 7" fein <i>delicate</i>



TC

Artikel-Nr. Cat. No.	Artikel-Nr. Cat. No.	Gesamtlänge Total length		
02-03-629		175 mm / 7" spitz sharp	DE BAKEY	1/1 
02-03-630		175 mm / 7" sehr fein very delicate	TOENNIS-ADSON	1/1 
02-03-631	02-03-273	175 mm / 7" fein delicate	TOENNIS-ADSON	1/1 

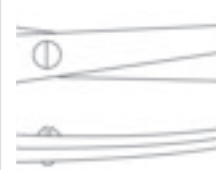

1/2
TOENNIS-ADSON
02-03-630
175mm
7"

Artikel-Nr. Cat. No.	Gesamtlänge Total length		
02-53-465	170 mm / 6¾"	TOENNIS-ADSON Supercut	1/1 



1/2
TOENNIS-ADSON
Supercut
02-53-465
170 mm
6¾"



 1/2
METZENBAUM
02-03-601
 145 mm
 5¾"



		TC				
		Artikel-Nr. Cat. No.	Artikel-Nr. Cat. No.	Gesamtlänge Total length		
1/1	METZEN- BAUM	02-03-601	02-03-260	145 mm / 5¾"		
		02-03-680		160 mm / 6¼"		
		02-03-602	02-03-262	180 mm / 7"		
		02-03-604	02-53-274	200 mm / 8"		
		02-03-611	02-03-266	230 mm / 9"		
		02-03-612	02-53-276	250 mm / 10"		
		02-03-613	02-53-286	280 mm / 11"		
		02-03-614	02-53-288	300 mm / 12"		
		1/1	METZEN- BAUM	02-03-605	02-03-261	145 mm / 5¾"
				02-03-683		160 mm / 6¼"
02-03-606	02-03-263			180 mm / 7"		
02-03-607	02-03-265			200 mm / 8"		
02-03-615	02-53-637			230 mm / 9"		
	02-03-287			230 mm / 9"		
				breite Blätter broad blade ends		
02-03-616	02-53-639			250 mm / 10"		
02-03-618	02-53-613			280 mm / 11"		
02-03-619	02-03-289			300 mm / 12"		
02-03-625		350 mm / 14"				

Black Line

 Oberfläche schwarz, titanbeschichtet
 Surface black, titanium-coated

 Beispiel-Artikel-Nr. **02-03-601B**
 Example Cat. No.

TC

Artikel-Nr. Cat. No.	Artikel-Nr. Cat. No.	Gesamtlänge Total length		
02-03-930	02-53-143	115 mm / 4½"		METZEN-BAUM Supercut 1/1
02-03-934	02-53-144	145 mm / 5¾"		
02-03-936	02-53-145	180 mm / 7"		
02-53-133	02-53-146	200 mm / 8"		
02-53-134	02-53-147	230 mm / 9"		
02-53-135	02-53-148	250 mm / 10"		
02-53-136	02-53-149	280 mm / 11"		
02-53-137	02-53-150	300 mm / 12"		
02-03-931	02-53-151	115 mm / 4½"		METZEN-BAUM Supercut 1/1
02-03-935	02-53-152	145 mm / 5¾"		
02-03-937	02-53-153	180 mm / 7"		
02-53-432	02-53-154	200 mm / 8"		
02-53-139	02-53-155	230 mm / 9"		
02-53-140	02-53-156	250 mm / 10"		
02-53-141	02-53-157	280 mm / 11"		
02-53-142	02-53-158	300 mm / 12"		



1/2
METZENBAUM Supercut
02-03-934
145 mm
5¾"

Black Line

Oberfläche schwarz, titanbeschichtet
Surface black, titanium-coated

Beispiel-Artikel-Nr. **02-03-934B**
Example Cat. No.



 1/2
METZENBAUM fino
02-03-600
 145 mm
 5¾"

		TC		
		Artikel-Nr. Cat. No.	Artikel-Nr. Cat. No.	Gesamtlänge Total length
1/1	METZEN- BAUM fino	02-53-599	02-03-256	115 mm / 4½"
		02-03-600	02-03-258	145 mm / 5¾"
		02-53-622	02-03-270	180 mm / 7"
		02-53-624	02-03-274	200 mm / 8"
		02-53-626	02-03-276	230 mm / 9"
		02-53-628	02-53-638	250 mm / 10"
1/1	METZEN- BAUM fino	02-53-610	02-53-612	280 mm / 11"
		02-53-601	02-03-257	115 mm / 4½"
		02-03-603	02-03-259	145 mm / 5¾"
		02-53-623	02-03-271	180 mm / 7"
		02-53-625	02-03-275	200 mm / 8"
		02-53-627	02-03-277	230 mm / 9"
		02-53-629	02-03-279	250 mm / 10"
		02-53-611	02-03-281	280 mm / 11"

 1/2
METZENBAUM fino
Supercut
02-53-490
 145 mm
 5¾"

		TC		
		Artikel-Nr. Cat. No.	Artikel-Nr. Cat. No.	Gesamtlänge Total length
1/1	METZEN- BAUM fino Supercut	02-53-490	02-53-500	145 mm / 5¾"
		02-53-491	02-53-501	180 mm / 7"
		02-53-492	02-53-502	200 mm / 8"
		02-53-493	02-53-503	230 mm / 9"
		02-53-494	02-53-504	250 mm / 10"
		02-53-495	02-53-505	280 mm / 11"
1/1	METZEN- BAUM fino Supercut	02-53-462	02-53-506	145 mm / 5¾"
		02-53-463	02-53-507	180 mm / 7"
		02-53-464	02-53-508	200 mm / 8"
		02-53-496	02-53-509	230 mm / 9"
		02-53-497	02-53-510	250 mm / 10"
		02-53-498	02-53-511	280 mm / 11"

Black Line

 Oberfläche schwarz, titanbeschichtet
 Surface black, titanium-coated

 Beispiel-Artikel-Nr.
 Example Cat. No. **02-03-600B**

TC

Artikel-Nr. Cat. No.	Artikel-Nr. Cat. No.	Gesamtlänge Total length		
02-53-520	02-53-528	140 mm / 5½"		1/1
02-53-521	02-53-529	180 mm / 7"		
02-53-522	02-53-530	200 mm / 8"		
02-53-523	02-53-531	230 mm / 9"		



1/2
METZENBAUM fino
02-53-520
140 mm
5½"

TC

Artikel-Nr. Cat. No.	Artikel-Nr. Cat. No.	Gesamtlänge Total length		
02-53-524	02-53-532	140 mm / 5½"		1/1
02-53-525	02-53-533	180 mm / 7"		
02-53-526	02-53-534	200 mm / 8"		
02-53-527	02-53-535	230 mm / 9"		



1/2
METZENBAUM fino
02-53-524
140 mm
5½"





1/1

**METZEN-
BAUM fino
„S“**

Artikel-Nr.
Cat. No.

02-53-514

TC

Artikel-Nr.
Cat. No.

02-53-515

Gesamtlänge
Total length

180 mm / 7"

1/2
METZENBAUM fino „S“
02-53-514
180 mm
7"



1/1

**METZEN-
BAUM
NELSON**

Artikel-Nr.
Cat. No.

02-53-516

02-53-517

Gesamtlänge
Total length



180 mm / 7"

200 mm / 8"

1/2
**METZENBAUM
NELSON**
02-53-516
180 mm
7"





TC

Artikel-Nr. Cat. No.	Artikel-Nr. Cat. No.	Gesamtlänge Total length		
02-03-544	02-03-250	140 mm / 5½"		MAYO 1/1
02-03-545		155 mm / 6"		
02-03-547	02-03-252	170 mm / 6¾"		
02-53-548		190 mm / 7½"		
02-53-549	02-53-254	230 mm / 9"		
02-53-550		280 mm / 11"		
02-03-554	02-03-251	140 mm / 5½"		MAYO 1/1
02-03-555		155 mm / 6"		
02-03-557	02-03-253	170 mm / 6¾"		
02-53-558		190 mm / 7½"		
02-53-559	02-53-255	230 mm / 9"		
02-53-560		280 mm / 11"		

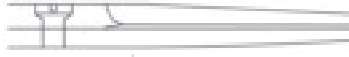

1/2
MAYO
02-03-547
170 mm
6¾"

TC

Artikel-Nr. Cat. No.	Artikel-Nr. Cat. No.	Gesamtlänge Total length		
02-53-466	02-53-477	140 mm / 5½"		MAYO Supercut 1/1
02-53-467	02-53-478	170 mm / 6¾"		
02-53-475	02-53-479	230 mm / 9"		
02-53-468	02-53-480	140 mm / 5½"		MAYO Supercut 1/1
02-53-469		170 mm / 6¾"		
02-53-476	02-53-481	230 mm / 9"		



1/2
MAYO
Supercut
02-53-467
170 mm
6¾"





TC

		Artikel-Nr. Cat. No.	Artikel-Nr. Cat. No.	Gesamtlänge Total length
1/1	MAYO- STILLE	02-03-580	02-53-278	150 mm / 6"
		02-03-584	02-03-242	170 mm / 6¾"
		02-03-585		200 mm / 8"
		02-53-576		210 mm / 8¼"
1/1	MAYO- STILLE	02-03-581	02-53-279	150 mm / 6"
		02-03-587	02-03-243	170 mm / 6¾"
		02-03-588		200 mm / 8"
		02-03-589		210 mm / 8¼"

1/2
MAYO STILLE
02-03-584
 170 mm
 6¾"





		Artikel-Nr. Cat. No.	Gesamtlänge Total length
1/1	LEXER fino	02-53-590	160 mm / 6¼"
1/1	LEXER fino	02-53-591	160 mm / 6¼"

1/2
LEXER fino
02-53-590
 160 mm
 6¼"



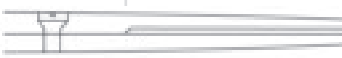

TC

Artikel-Nr. Cat. No.	Artikel-Nr. Cat. No.	Gesamtlänge Total length		
02-03-590	02-53-282	165 mm / 6½"		LEXER 1/1
02-53-592	02-53-284	210 mm / 8¼"		
02-03-591	02-03-283	165 mm / 6½"		LEXER 1/1
02-53-593	02-53-285	210 mm / 8¼"		



1/2
LEXER
02-03-590
165 mm
6½"

TC

Artikel-Nr. Cat. No.	Artikel-Nr. Cat. No.	Gesamtlänge Total length		
02-03-924	02-53-584	165 mm / 6½"		LEXER Supercut 1/1
02-53-581	02-53-585	210 mm / 8¼"		
02-03-925	02-53-586	165 mm / 6½"		LEXER Supercut 1/1
02-53-583	02-53-587	210 mm / 8¼"		



1/2
LEXER
Supercut
02-03-924
165 mm
6½"





		Artikel-Nr. Cat. No.	Gesamtlänge Total length
1/1	BARRÈ	02-03-715	280 mm / 11"



2/3
BARRÈ
 02-03-715
 280 mm
 11"



		Artikel-Nr. Cat. No.	Gesamtlänge Total length
1/1	WELLER	02-03-620	280 mm / 11"

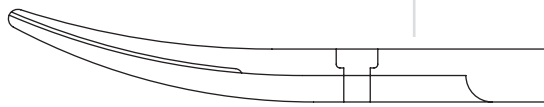

2/3
WELLER
 02-03-620
 280 mm
 11"



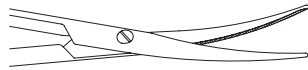

TC

Artikel-Nr.
Cat. No.

Gesamtlänge
Total length

02-03-257W

115 mm / 4½"

1/1



1/2
02-03-257W
115 mm
4½"

TC

Artikel-Nr.
Cat. No.

Gesamtlänge
Total length

02-03-259W

145 mm / 5¾"

BABY-
METZEN-
BAUM

1/1



1/2
BABY-
METZENBAUM
02-03-259W
145 mm
5¾"

Black Line

Oberfläche schwarz, titanbeschichtet
Surface black, titanium-coated

Beispiel-Artikel-Nr. **02-03-257WB**
Example Cat. No.



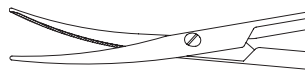

1/2
TOENNIS-ADSON
 02-03-273W
 175 mm
 7"

		TC	
		Artikel-Nr. Cat. No.	Gesamtlänge Total length
1/1	TOENNIS-ADSON	02-03-273W	175 mm / 7"



1/2
MAYO
 02-03-253W
 170 mm
 6¾"

		TC	
		Artikel-Nr. Cat. No.	Gesamtlänge Total length
1/1	MAYO	02-03-253W	170 mm / 6¾"

Black Line

Oberfläche schwarz, titanbeschichtet
 Surface black, titanium-coated

Beispiel-Artikel-Nr.
 Example Cat. No. **02-03-253WB**

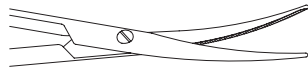

TC

Artikel-Nr.
Cat. No.

Gesamtlänge
Total length

02-03-283W	165 mm / 6½"	LEXER	1/1
------------	--------------	-------	-----



1/2
LEXER
02-03-283W
165 mm
6½"

TC

Artikel-Nr.
Cat. No.

Gesamtlänge
Total length

02-03-261W	145 mm / 5¾"	METZEN- BAUM	1/1
02-03-263W	180 mm / 7"		
02-03-265W	200 mm / 8"		



1/2
METZENBAUM
02-03-261W
145 mm
5¾"

Black Line

Oberfläche schwarz, titanbeschichtet
Surface black, titanium-coated

Beispiel-Artikel-Nr. 02-03-261WB
Example Cat. No.

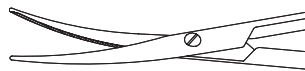

 1/3
**NELSON-
 METZENBAUM**
 02-03-267W
 230 mm
 9"

		TC	
		Artikel-Nr. Cat. No.	Gesamtlänge Total length
1/1	NELSON- METZEN- BAUM	02-03-267W	230 mm / 9"



 1/3
METZENBAUM
 02-03-287W
 230 mm
 9"

		TC	
		Artikel-Nr. Cat. No.	Gesamtlänge Total length
1/1	METZEN- BAUM	02-03-287W	230 mm / 9"

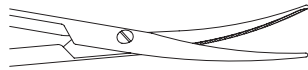

Black Line

 Oberfläche schwarz, titanbeschichtet
 Surface black, titanium-coated

 Beispiel-Artikel-Nr.
 Example Cat. No. **02-03-267WB**



TC

Artikel-Nr. Cat. No.	Gesamtlänge Total length		
02-03-271W	180 mm / 7"	METZEN- BAUM fino	1/1
02-03-275W	200 mm / 8"		
02-03-277W	230 mm / 9"		



1/2
METZENBAUM fino
02-03-271W
180 mm
7"

TC

Artikel-Nr. Cat. No.	Gesamtlänge Total length		
02-03-279W	260 mm / 10 $\frac{1}{4}$ "	NELSON- METZEN- BAUM	1/1
02-03-281W	280 mm / 11"		



1/3
NELSON-
METZENBAUM
02-03-279W
260 mm
10 $\frac{1}{4}$ "

Black Line

Oberfläche schwarz, titanbeschichtet
Surface black, titanium-coated

Beispiel-Artikel-Nr. **02-03-271WB**
Example Cat. No.





1/2
02-03-211W
110 mm
4 3/8"

		TC	
		Artikel-Nr. Cat. No.	Gesamtlänge Total length
1/1		02-03-211W	110 mm / 4 3/8"







1/2
02-03-294W
145 mm
5 3/4"

		TC	
		Artikel-Nr. Cat. No.	Gesamtlänge Total length
1/1		02-03-294W	145 mm / 5 3/4"
1/1		02-03-295W	180 mm / 7"
1/1		02-03-296W	230 mm / 9"
1/1		02-03-297W	260 mm / 1 1/4"

Black Line
Oberfläche schwarz, titanbeschichtet
Surface black, titanium-coated
Beispiel-Artikel-Nr. **02-03-211WB**
Example Cat. No.

TC

Artikel-Nr. Cat. No.	Artikel-Nr. Cat. No.	Gesamtlänge Total length		
02-53-640	02-53-650	135 mm / 5¼"	DIETHRICH-HEGEMANN	1/1 25° 
02-53-641		160 mm / 6¼"		
02-03-662		180 mm / 7"		
02-53-642	02-53-651	135 mm / 5¼"	DIETHRICH-HEGEMANN	1/1 45° 
02-53-643		160 mm / 6¼"		
02-03-663		180 mm / 7"		
02-53-644	02-53-652	135 mm / 5¼"	DIETHRICH-HEGEMANN	1/1 60° 
02-53-645		160 mm / 6¼"		
02-03-664		180 mm / 7"		
02-53-646	02-53-653	135 mm / 5¼"	DIETHRICH-HEGEMANN	1/1 90° 
02-53-647		160 mm / 6¼"		
02-03-653		180 mm / 7"		
02-53-648	02-53-654	135 mm / 5¼"	DIETHRICH-HEGEMANN	1/1 125° 
02-53-649		160 mm / 6¼"		
02-03-654		180 mm / 7"		



1/2
DIETHRICH-HEGEMANN
02-03-663
180 mm
7"





1/3
POTTS-DE MARTELL
02-03-649
 185 mm
 7¼"



1/1

25°

**POTTS-DE
 MARTELL**

 Artikel-Nr.
 Cat. No.

02-03-647

TC

 Artikel-Nr.
 Cat. No.

02-53-658

 Gesamtlänge
 Total length

185 mm / 7¼"



1/1

45°

**POTTS-DE
 MARTELL**

 Artikel-Nr.
 Cat. No.

02-03-648

 Artikel-Nr.
 Cat. No.

02-53-659

185 mm / 7¼"



1/1

60°

**POTTS-DE
 MARTELL**

 Artikel-Nr.
 Cat. No.

02-03-649

 Artikel-Nr.
 Cat. No.

02-53-660

185 mm / 7¼"



1/1

60°

**POTTS-DE
 MARTELL**

 Artikel-Nr.
 Cat. No.

02-03-650

210 mm / 8¼"



1/1

60°

MILLS

 Artikel-Nr.
 Cat. No.

02-03-651

220 mm / 8¾"



1/3
POTTS-DE MARTELL
Supercut
02-53-681
 185 mm
 7¼"



1/1

25°

**POTTS-DE
 MARTELL
 Supercut**

 Artikel-Nr.
 Cat. No.

02-53-680

TC

 Artikel-Nr.
 Cat. No.

02-53-683

 Gesamtlänge
 Total length

185 mm / 7¼"



1/1

45°

**POTTS-DE
 MARTELL
 Supercut**

 Artikel-Nr.
 Cat. No.

02-53-681

 Artikel-Nr.
 Cat. No.

02-53-684

185 mm / 7¼"



1/1

60°

**POTTS-DE
 MARTELL
 Supercut**

 Artikel-Nr.
 Cat. No.

02-53-682

 Artikel-Nr.
 Cat. No.

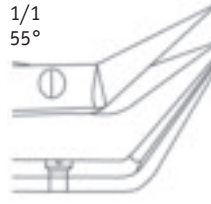

02-53-685

185 mm / 7¼"

Artikel-Nr. Cat. No.	Gesamtlänge Total length		
02-03-646	180 mm / 7"	POTTS-SMITH	1/1 55° 



1/3
POTTS-SMITH
02-03-646
180 mm
7"

TC		Artikel-Nr. Cat. No.	Artikel-Nr. Cat. No.	Gesamtlänge Total length		
02-53-661	02-53-655	160 mm / 6¼"	DE BAKEY	1/1 25° 		
02-53-690	02-53-693	180 mm / 7"				
02-53-662	02-53-694	230 mm / 9"				
02-53-663		280 mm / 11"				
02-53-664	02-53-656	160 mm / 6¼"	DE BAKEY	1/1 45° 		
02-53-691	02-53-695	180 mm / 7"				
02-53-665	02-53-696	230 mm / 9"				
02-53-666	02-53-697	280 mm / 11"				
02-53-667	02-53-657	160 mm / 6¼"	DE BAKEY	1/1 60° 		
02-53-692	02-53-698	180 mm / 7"				
02-53-668	02-03-245	230 mm / 9"				
02-53-669		280 mm / 11"				



1/2
DE BAKEY
02-53-664
160 mm
6¼"





1/2
DIETHRICH
 02-53-673
 180 mm
 7"

		Artikel-Nr. Cat. No.	Gesamtlänge Total length
1/1 125° 	DIETHRICH	02-53-673	180 mm / 7"

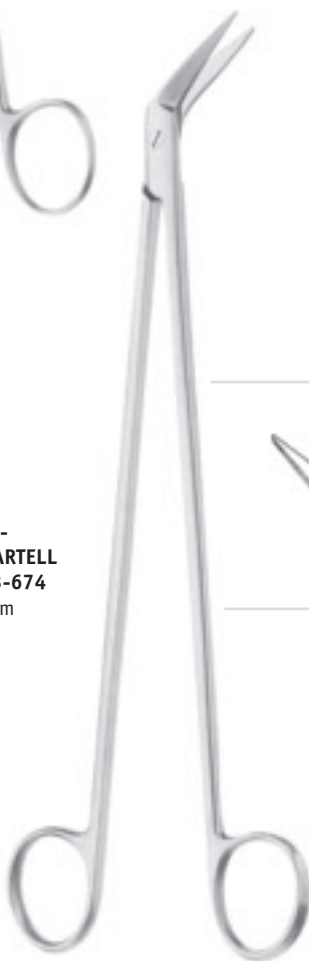



1/2
**POTTS-
 DE MARTELL**
 02-53-674
 240 mm
 9½"

		Artikel-Nr. Cat. No.	Gesamtlänge Total length
1/1 	POTTS- DE MARTELL	02-03-650 02-53-674	210 mm / 8¼" 240 mm / 9½"



1/2
POTTS-SMITH
 02-03-652
 180 mm
 7"

		Artikel-Nr. Cat. No.	Gesamtlänge Total length
1/1 60° 	POTTS- SMITH	02-03-652	180 mm / 7"

Artikel-Nr. Cat. No.	Gesamtlänge Total length		
02-53-679	155 mm / 6"	DE BAKEY	1/1
	Offsetschere <i>offset scissors</i>		
02-03-669	155 mm / 6"	DE BAKEY	1/1 45°
	Offsetschere <i>offset scissors</i>		



1/2
DE BAKEY
02-53-679
155 mm
6"

Artikel-Nr. Cat. No.	Gesamtlänge Total length		
02-03-670	140 mm / 5½"	FAVALORO	1/1 55°
	Coronararterien-Schere <i>coronary artery scissors</i>		



1/2
FAVALORO
02-03-670
140 mm
5½"





1/2
BEAL
02-53-035
 150 mm
 6"

		Artikel-Nr. Cat. No.	Gesamtlänge Total length
1/1 115° BEAL Circumflex	02-53-035	spitz pointed	150 mm / 6"
1/1 115° BEAL Circumflex	02-53-036	stumpf blunt	150 mm / 6"



1/2
POTTS-SMITH
02-53-037
 190 mm
 7½"

		Artikel-Nr. Cat. No.	Gesamtlänge Total length
1/1 POTTS-SMITH	02-53-037		190 mm / 7½"

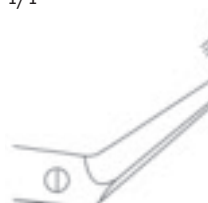

Artikel-Nr. Cat. No.	Gesamtlänge Total length		
02-03-660	170 mm / 6¾"	SCHMIEDEN-TAYLOR	1/1
	Duraschere <i>dura scissors</i>		



1/2
SCHMIEDEN-TAYLOR
02-03-660
 170 mm
 6¾"

Artikel-Nr. Cat. No.	Schaftlänge Length of the shaft		
02-03-665	180 mm / 7"	OLIVECRONA	1/1
	Duraschere <i>dura scissors</i>		

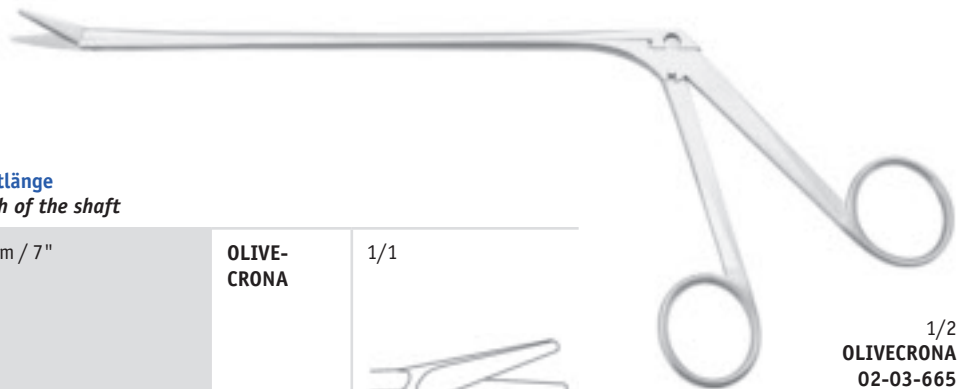

1/2
OLIVECRONA
02-03-665
 180 mm
 7"







1/2
MC INDOE
02-03-672
 190 mm
 7½"

		Artikel-Nr. Cat. No.	Gesamtlänge Total length
1/1	MC INDOE	02-03-672	190 mm / 7½"
			Knorpelschere, gezahnt <i>cartilage scissors, toothed</i>



1/2
DANDY
02-53-671
 170 mm
 6¾"

		Artikel-Nr. Cat. No.	Gesamtlänge Total length
1/1	DANDY	02-53-671	170 mm / 6¾"
		02-53-672	190 mm / 7½"
			Trigeminusschere <i>trigeminal scissors</i>

Artikel-Nr. Cat. No.	Gesamtlänge Total length		
02-53-038	190 mm / 7½"		1/1
02-53-039	190 mm / 7½"		1/1



1/2
02-53-038
 190 mm
 7½"

Artikel-Nr. Cat. No.	Gesamtlänge Total length		
02-03-642	225 mm / 9" spitz / spitz sharp / sharp		1/1



1/2
02-03-642
 225 mm
 9"





1/2
THOREK
02-03-636
 190 mm
 7½"

		Artikel-Nr. Cat. No.	Gesamtlänge Total length
1/1	THOREK	02-03-636	190 mm / 7½"
		02-53-712	250 mm / 10"



1/2
STRULLY
02-03-645
 220 mm
 8¾"

		Artikel-Nr. Cat. No.	Gesamtlänge Total length
1/1	STRULLY	02-03-644	220 mm / 8¾" spitz pointed
1/1	STRULLY	02-03-645	220 mm / 8¾" geknöpft probe pointed



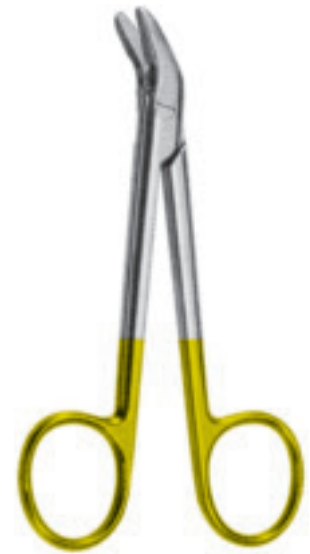

TC

Artikel-Nr. Cat. No.	Gesamtlänge Total length		
04-16-552	120 mm / 4¾"		1/1
	Draht- und Blehschere, 1 Schneide gezahnt wire cutting scissors, 1 blade toothed		



1/2
04-16-552
120 mm
4¾"

Artikel-Nr. Cat. No.	Gesamtlänge Total length		
02-03-801	90 mm / 3½"	SPENCER	1/1
			
02-03-802	110 mm / 4¼"	SPENCER	1/1
			
02-53-800	120 mm / 4¾"	SPENCER	1/1
			



1/2
SPENCER
02-03-802
110 mm
4¼"

Artikel-Nr. Cat. No.	Gesamtlänge Total length		
02-03-803	140 mm / 5½"	LITTAUER	1/1
			



1/2
LITTAUER
02-03-803
140 mm
5½"





1/2
FOMON
 15-11-370
 145 mm
 5¾"

		Artikel-Nr. Cat. No.	Gesamtlänge Total length
1/1	FOMON	15-11-370	145 mm / 5¾"
			Schneiden gezahnt blades toothed



1/2
COTTLE
 15-11-371
 165 mm
 6½"

		Artikel-Nr. Cat. No.	Gesamtlänge Total length
1/1	COTTLE	15-11-371	165 mm / 6½"

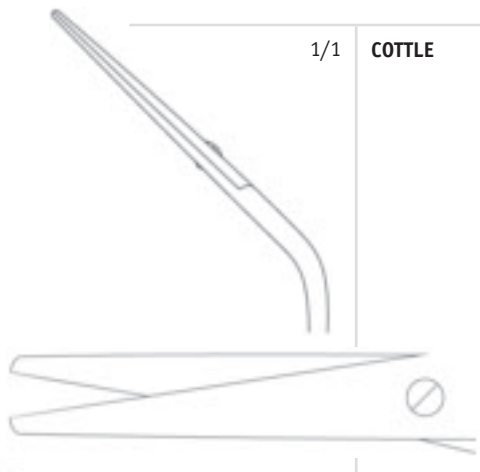

Artikel-Nr. Cat. No.	Gesamtlänge Total length		
15-11-350	175 mm / 7"	HEYMANN- KNIGHT	1/1
15-11-351	190 mm / 7½"		



Artikel-Nr. Cat. No.	Gesamtlänge Total length		
15-11-352	175 mm / 7" Schneiden gezahnt blades toothed	KIRSTEIN	1/1

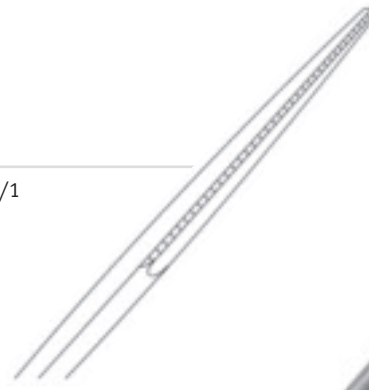

1/2
HEYMANN-
KNIGHT
15-11-351
190 mm
7½"





2/3
15-03-021
100 mm
4"





		Artikel-Nr. Cat. No.	Gesamtlänge Total length
1/1		15-03-020	100 mm / 4"
1/1		15-03-021	100 mm / 4"
1/1		15-03-022	100 mm / 4"







2/3
02-04-215
125 mm
5"

TITAN

		Artikel-Nr. Cat. No.	Artikel-Nr. Cat. No.	Gesamtlänge Total length
1/1		02-04-210		115 mm / 4½"
1/1	SEMKEN 	02-04-215	02-04-215T	125 mm / 5"
1/1		02-04-500		100 mm / 4"
1/1		02-04-501		110 mm / 4¾"
1/1		02-04-502		110 mm / 4¾"
1/1	SEMKEN 	02-04-668		125 mm 5¾"
		02-04-669		145 mm / 5¾"
1/1	SEMKEN 	02-04-665		125 mm / 5"
		02-04-667		150 mm / 6"
1/1	SEMKEN 	02-04-666		125 mm / 5"

Artikel-Nr. Cat. No.	Gesamtlänge Total length		
02-04-301	90 mm / 3½"		1/1 
02-04-302	105 mm / 4¼"		1/1 
02-04-303	115 mm / 4½"		1/1 
02-04-304	125 mm / 5"		1/1 
02-04-305	145 mm / 5¾"		1/1 

Artikel-Nr. Cat. No.	Gesamtlänge Total length		
02-04-311	90 mm / 3½"		1/1 
02-04-312	105 mm / 4¼"		1/1 
02-04-313	115 mm / 4½"		1/1 
02-04-314	125 mm / 5"		1/1 
02-04-315	145 mm / 5¾"		1/1 



1/1
02-04-304
125 mm
5"





1/2
MICRO-ADSON
02-04-223
150 mm
6"

		Artikel-Nr. Cat. No.	Gesamtlänge Total length
1/1	MICRO-ADSON	02-04-220	120 mm / 4¾"
1/1	MICRO-ADSON	02-04-223	150 mm / 6"



1/2
MICRO-ADSON
02-04-520
150 mm
6"

		Artikel-Nr. Cat. No.	Gesamtlänge Total length
1/1	MICRO-ADSON BIEMER	02-04-509	120 mm / 4¾"
1/1	MICRO-ADSON BIEMER	02-04-510	120 mm / 4¾"
1/1	MICRO-ADSON	02-04-520	150 mm / 6"
1/1	MICRO-ADSON	02-54-521	180 mm / 7"



1/2
MICRO-ADSON
02-54-523
150 mm
6"

TC

		Artikel-Nr. Cat. No.	Gesamtlänge Total length
1/1	MICRO-ADSON	02-54-522	120 mm / 4¾"
1/1	MICRO-ADSON	02-54-523	150 mm / 6"

TITAN

Artikel-Nr. Cat. No.	Artikel-Nr. Cat. No.	Gesamtlänge Total length	ADSON	1/1
02-04-222	02-04-222T	120 mm / 4¾"	ADSON	1/1
02-54-223		150 mm / 6"	ADSON	1/1
02-04-224		180 mm / 7"	ADSON	1/1
02-04-226		180 mm / 7"	ADSON	1/1



2/3
ADSON
02-04-222
120 mm
4¾"

TC

Artikel-Nr. Cat. No.	Gesamtlänge Total length	ADSON	1/1
02-04-151	120 mm / 4¾"	ADSON	1/1
02-54-152	150 mm / 6"	ADSON	1/1
02-54-153	120 mm / 4¾"	ADSON	1/1
02-54-154	150 mm / 6"	ADSON	1/1



2/3
ADSON
02-04-153
120 mm
4¾"





2/3
02-04-511
120 mm
4 3/4"





		Artikel-Nr. Cat. No.	Gesamtlänge Total length
	1/1	ADSON 02-04-511	120 mm / 4 3/4"
	1/1	ADSON 13-02-454	120 mm / 4 3/4"
	1/1	ADSON 02-04-512 02-54-513	120 mm / 4 3/4" 150 mm / 6"
	1/1	ADSON 02-04-522	180 mm / 7"
	1/1	JEFFERSON 02-04-523	180 mm / 7"
	1/1	ADSON-BROWN 02-04-700	120 mm / 4 3/4"



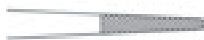

1/1
ADSON
02-04-521
150 mm
6"

		Artikel-Nr. Cat. No.	Gesamtlänge Total length
	1/1	ADSON 02-04-506	120 mm / 4 3/4"
	1/1	ADSON 02-04-508	120 mm / 4 3/4"
	1/1	ADSON 02-04-507	120 mm / 4 3/4"
	1/1	ADSON 02-04-513	120 mm / 4 3/4"
	1/1	ADSON 02-04-521	150 mm / 6"

TC

Artikel-Nr. Cat. No.	Gesamtlänge Total length		
02-04-154	145 mm / 5¾"		1/1 
02-04-155	160 mm / 6¼"		1/1 
02-04-156	180 mm / 7"		1/1 
02-04-157	200 mm / 8"		1/1 
02-04-158	230 mm / 9"		1/1 
02-04-159	250 mm / 10"		1/1 

TC

Artikel-Nr. Cat. No.	Gesamtlänge Total length		
02-04-164	145 mm / 5¾"	STANDARD	1/1 
02-04-165	200 mm / 8"	STANDARD	1/1 
02-04-166	250 mm / 10"	STANDARD	1/1 



1/1
02-04-154
145 mm
5¾"





1/1
02-04-047
 145 mm
 5¾"



		Artikel-Nr. Cat. No.	Gesamtlänge Total length
1/1	STANDARD	02-04-043	115 mm / 4½"
1/1	STANDARD	02-04-045	130 mm / 5⅛"
1/1	STANDARD	02-04-047	145 mm / 5¾"
1/1	STANDARD	02-04-049	160 mm / 6¼"
1/1	STANDARD	02-04-050	180 mm / 7"
1/1	STANDARD	02-04-051	200 mm / 8"
1/1	STANDARD	02-04-052	250 mm / 10"
1/1	STANDARD	02-04-053	300 mm / 12"



Artikel-Nr. Cat. No.	Gesamtlänge Total length		
02-04-023	115 mm / 4½"		1/1 
02-04-025	130 mm / 5¼"		1/1 
02-04-027	145 mm / 5¾"		1/1 
02-04-029	160 mm / 6¼"		1/1 
02-04-030	180 mm / 7"		1/1 
02-04-031	200 mm / 8"		1/1 
02-04-032	250 mm / 10"		1/1 
02-04-033	300 mm / 12"		1/1 

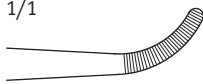

1/1
02-04-027
145 mm
5¾"

Artikel-Nr. Cat. No.	Gesamtlänge Total length		
02-04-035	130 mm / 5¼"		1/1 
02-04-037	145 mm / 5¾"		1/1 



1/1
02-04-557
 145 mm
 5¾"

		Artikel-Nr. Cat. No.	Gesamtlänge Total length
1/1	STANDARD	02-04-553	115 mm / 4½"
1/1	STANDARD	02-04-555	130 mm / 5⅛"
1/1	STANDARD	02-04-557	145 mm / 5¾"
1/1	STANDARD	02-04-559	160 mm / 6¼"
1/1	STANDARD	02-04-560	180 mm / 7"
1/1	STANDARD	02-04-561	200 mm / 8"
1/1	STANDARD	02-04-562	250 mm / 10"
1/1	STANDARD	02-04-563	300 mm / 12"



Artikel-Nr. Cat. No.		Gesamtlänge Total length		
02-04-533	schmal narrow	115 mm / 4½"		1/1 
02-04-535	schmal narrow	130 mm / 5¼"		1/1 
02-04-537	schmal narrow	145 mm / 5¾"		1/1 
02-04-539	schmal narrow	160 mm / 6¼"		1/1 
02-04-540	schmal narrow	180 mm / 7"		1/1 
02-04-541	schmal narrow	200 mm / 8"		1/1 
02-04-542	schmal narrow	250 mm / 10"		1/1 
02-04-543	schmal narrow	300 mm / 12"		1/1 



1/1
02-04-537
145 mm
5¾"





1/2
CUSHING
02-04-238
180 mm
7"







		Artikel-Nr. Cat. No.	Gesamtlänge Total length
1/1	CUSHING	02-04-238	180 mm / 7"
1/1	CUSHING	02-04-239	200 mm / 8"
1/1	CUSHING	02-04-243	200 mm / 8"
1/1	CUSHING	02-04-240	250 mm / 10"



1/2
02-04-231
185 mm
7 1/4"

		Artikel-Nr. Cat. No.	Gesamtlänge Total length
1/1	BROPHY	02-04-246	200 mm / 8"
1/1	BROPHY	02-04-247	200 mm / 8"
1/1	BROPHY	02-54-248	300 mm / 8"
1/1	BROPHY	02-04-678	200 mm / 8"

		Artikel-Nr. Cat. No.	Gesamtlänge Total length
1/1		02-04-231	185 mm / 7 1/4"
1/1		02-04-232	200 mm / 8"
1/1		02-04-257	200 mm / 8"

Artikel-Nr. Cat. No.	Gesamtlänge Total length		
02-54-574	115 mm / 4½"		1/1 
02-54-575	130 mm / 5"		1/1 
02-54-577	145 mm / 5¾"		1/1 
02-54-579	160 mm / 6¼"		1/1 
02-54-580	180 mm / 7"		1/1 
02-54-581	200 mm / 8"		1/1 
02-54-582	250 mm / 10"		1/1 



1/1
02-04-579
160 mm
6¼"





1/2
BROWN
02-04-701
150 mm
6"

		Artikel-Nr. Cat. No.	Gesamtlänge Total length
1/1	BROWN	02-04-701	150 mm / 6"
1/1	BROWN	02-04-702	200 mm / 8"





1/2
02-04-587
145 mm
5 3/4"

		Artikel-Nr. Cat. No.	Gesamtlänge Total length
1/1		02-04-587	145 mm / 5 3/4"
1/1		02-04-589	160 mm / 6 1/4"
1/1		02-04-591	200 mm / 8"





1/2
LANE
02-04-602
125 mm
5"

		Artikel-Nr. Cat. No.	Gesamtlänge Total length
1/1	LANE	02-04-602	125 mm / 5"
1/1	LANE	02-04-603	145 mm / 5 3/4"
1/1	LANE	02-04-604	145 mm / 5 3/4"
1/1	LANE	02-04-606	175 mm / 7"
1/1	LANE	02-04-607	175 mm / 7"

		TITAN	TC		
Artikel-Nr. Cat. No.	Artikel-Nr. Cat. No.	Artikel-Nr. Cat. No.	Gesamtlänge Total length		
02-04-236	02-04-236T		150 mm / 6"	MC INDOE	1/1 
		02-54-237	150 mm / 6"	MC INDOE	1/1 
02-04-661			150 mm / 6"	MC INDOE	1/1 



2/3
MC INDOE
02-54-237
150 mm
6"

		TC		
Artikel-Nr. Cat. No.	Artikel-Nr. Cat. No.	Gesamtlänge Total length		
02-04-213		150 mm / 6"	GILLIES	1/1 
02-04-660		150 mm / 6"	GILLIES	1/1 
	02-54-661	150 mm / 6"	GILLIES	1/1 



2/3
GILLIES
02-54-661
150 mm
6"



1/2
CUSHING
13-04-463
 170 mm
 6¾"

			Artikel-Nr. Cat. No.	Gesamtlänge Total length
	1/1	CAIRNS-DOTT	02-04-268	175 mm / 7"
	1/1	CUSHING	13-04-463	170 mm / 6¾"



1/2
CUSHING
02-04-160
 180 mm
 7"

			TC Artikel-Nr. Cat. No.	Gesamtlänge Total length
	1/1	CUSHING	02-04-160	180 mm / 7"
	1/1	CUSHING	02-54-161	170 mm / 6¾"
	1/1	CUSHING	02-54-162	170 mm / 6¾"



TITAN

Artikel-Nr. Cat. No.	Artikel-Nr. Cat. No.	Gesamtlänge Total length	GERALD	1/1
02-04-228	02-04-228T	175 mm / 7"		
02-04-229		175 mm / 7"		
02-04-230		230 mm / 9"		

1/2
GERALD
02-04-228
175 mm
7"



Artikel-Nr. Cat. No.	Gesamtlänge Total length	GERALD	1/1
02-04-662	175 mm / 7"		
02-04-663	175 mm / 7"		
02-04-664	230 mm / 9"		

1/2
GERALD
02-04-662
175 mm
7"





1/2
WAUGH
02-04-671
200 mm
8"

		Artikel-Nr. Cat. No.	Gesamtlänge Total length
	1/1 WAUGH	02-04-670	180 mm / 7"
	1/1 WAUGH	02-04-671	200 mm / 8"
	1/1 WAUGH	02-04-672	250 mm / 10"
	1/1 WAUGH	02-04-679	305 mm / 12"



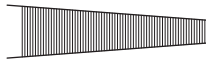
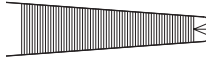

1/2
TREVES
02-04-609
150 mm
6"

		Artikel-Nr. Cat. No.	Gesamtlänge Total length
	1/1 TREVES	02-04-608	125 mm / 5"
	1/1 TREVES	02-04-609	150 mm / 6"

Artikel-Nr. Cat. No.	Gesamtlänge Total length		
02-04-078	175 mm / 7"	BONNEY	1/1 
02-04-693	175 mm / 7"	BONNEY	1/1 

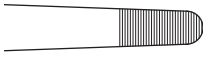

1/2
BONNEY
02-04-693
175 mm
7"

Artikel-Nr. Cat. No.	Gesamtlänge Total length		
02-04-083	180 mm / 7"	RAMSEY	1/1 
02-04-610	180 mm / 7"	RAMSEY	1/1 
02-04-611	180 mm / 7"	RAMSEY	1/1 







1/2
RAMSEY
02-04-610
180 mm
7"

ATRAUMA

DE BAKEY

TITAN

		Artikel-Nr. Cat. No.	Artikel-Nr. Cat. No.	Gesamtlänge Total length
	1/1 1,5 mm	DE BAKEY 06-02-411	06-02-411T	160 mm / 6¼"
		06-02-412	06-02-412T	200 mm / 8"
		06-52-100	06-52-100T	240 mm / 9½"
		06-52-101	06-52-101T	300 mm / 12"
	1/1 1,5 mm	DE BAKEY 06-52-102		160 mm / 6¼"
		06-52-103		200 mm / 8"
		06-52-104		240 mm / 9½"
		06-52-105		300 mm / 12"
	1/1 2,0 mm	DE BAKEY 06-02-400	06-02-400T	160 mm / 6¼"
		06-02-402	06-02-402T	200 mm / 8"
		06-02-404	06-02-404T	240 mm / 9½"
		06-02-405	06-02-405T	300 mm / 12"
	1/1 2,0 mm	DE BAKEY 06-02-401	06-02-401T	160 mm / 6¼"
		06-02-403	06-02-403T	200 mm / 8"
		06-52-119	06-52-119T	240 mm / 9½"
		06-52-120	06-52-120T	300 mm / 12"
	1/1 2,4 mm	DE BAKEY 06-52-106	06-52-106T	160 mm / 6¼"
		06-52-107	06-52-107T	200 mm / 8"
		06-52-108	06-52-108T	240 mm / 9½"
		06-52-109	06-52-109T	300 mm / 12"

 1/1
DE BAKEY
06-02-412
 200 mm
 8"

TITAN

Artikel-Nr. Cat. No.	Artikel-Nr. Cat. No.	Gesamtlänge Total length		
06-02-414	06-02-414T	160 mm / 6¼"	DE BAKEY	1/1 2,8 mm
06-02-415	06-02-415T	200 mm / 8"		
06-02-416	06-02-416T	240 mm / 9½"		
06-02-417	06-02-417T	300 mm / 12"		
06-52-110		160 mm / 6¼"	DE BAKEY	1/1 2,8 mm
06-52-111		200 mm / 8"		
06-52-112		240 mm / 9½"		
06-52-113		300 mm / 12"		
06-52-114	06-52-114T	160 mm / 6¼"	DE BAKEY	1/1 3,5 mm
06-52-115	06-52-115T	200 mm / 8"		
06-52-116	06-52-116T	240 mm / 9½"		
06-52-117	06-52-117T	300 mm / 12"		
06-52-118		160 mm / 6¼"	DE BAKEY	1/1 3,5 mm
06-02-406		200 mm / 8"		
06-02-407		240 mm / 9½"		
06-02-408		300 mm / 12"		
06-02-409		350 mm / 14"		

ATRAUMA



DE BAKEY



1/1
DE BAKEY
06-02-414
160 mm
6¼"



ATRAUMA

DE BAKEY

 1/1
 1,0 mm

DE BAKEY
Artikel-Nr.
Cat. No.
06-02-394
06-02-395
06-02-396
Gesamtlänge
Total length

150 mm / 6"

195 mm / 7¾"





240 mm / 9½"

 1/1
DE BAKEY
06-02-395
 195 mm
 7¾"

ATRAUMA



DE BAKEY

Artikel-Nr. Cat. No.	Gesamtlänge Total length		
06-03-411	150 mm / 6"	DE BAKEY	1/1 1,2 mm 
06-03-412	200 mm / 8"	DE BAKEY	1/1 1,5 mm 
06-03-413	240 mm / 9½"	DE BAKEY	1/1 1,5 mm 
06-03-418	300 mm / 12"	DE BAKEY	1/1 1,5 mm 



1/2
DE BAKEY
06-03-412
200 mm
8"



ATRAUMA

COOLEY

 1/1
 2,0 mm

COOLEY
Artikel-Nr.
Cat. No.
Gesamtlänge
Total length
06-02-784

160 mm / 6¼"

06-02-785

200 mm / 8"

06-52-786

240 mm / 9½"

10

 1/1
COOLEY
06-02-785
 200 mm
 8"

Area with horizontal lines for notes.





2/3
BABY-MOSQUITO
02-08-104
100 mm
4"



		Artikel-Nr. Cat. No.	Gesamtlänge Total length
1/1	BABY-MOSQUITO	02-08-104	100 mm / 4"
1/1	BABY-MOSQUITO	02-08-105	100 mm / 4"
1/1	BABY-MOSQUITO	02-08-114	100 mm / 4"
1/1	BABY-MOSQUITO	02-08-115	100 mm / 4"
1/1	MICRO-HALSTED	02-08-108	125 mm / 5"
1/1	MICRO-HALSTED	02-08-109	125 mm / 5"
1/1	MICRO-HALSTED	02-08-118	125 mm / 5"
1/1	MICRO-HALSTED	02-08-119	125 mm / 5"



2/3
HALSTED-MOSQUITO
02-08-110
125 mm
5"



		Artikel-Nr. Cat. No.	TITAN Artikel-Nr. Cat. No.	Gesamtlänge Total length
1/1	HALSTED-MOSQUITO	02-08-110	02-08-110T	125 mm / 5"
1/1	HALSTED-MOSQUITO	02-08-111	02-08-111T	125 mm / 5"
1/1	HALSTED-MOSQUITO	02-08-120	02-08-120T	125 mm / 5"
1/1	HALSTED-MOSQUITO	02-08-121	02-08-121T	125 mm / 5"

Artikel-Nr. Cat. No.	Gesamtlänge Total length		
02-08-123	125 mm / 5"	DUNHILL	1/1 



Artikel-Nr. Cat. No.	Gesamtlänge Total length		
02-08-124	140 mm / 5½"	CAIRNS	1/1 
02-08-125	140 mm / 5½"	CAIRNS	1/1 



1/2
CAIRNS
02-08-124
140 mm
5½"

Artikel-Nr. Cat. No.	Gesamtlänge Total length		
02-08-130	140 mm / 5½"	PROVIDENCE-HOSPITAL	1/1 
02-08-131	140 mm / 5½"	PROVIDENCE-HOSPITAL	1/1 

TITAN

Artikel-Nr. Cat. No.	Artikel-Nr. Cat. No.	Gesamtlänge Total length		
02-08-134	02-08-134T	140 mm / 5½"	KELLY	1/1 
02-08-135	02-08-135T	140 mm / 5½"	KELLY	1/1 



1/2
KELLY
02-08-134
140 mm
5½"









1/2
BABY-CRILE
02-08-140
140 mm
5½"

		Artikel-Nr. Cat. No.	Gesamtlänge Total length
1/1	BABY-CRILE	02-08-140	140 mm / 5½"
1/1	BABY-CRILE	02-08-141	140 mm / 5½"
1/1	BABY-CRILE	02-08-150	140 mm / 5½"
1/1	BABY-CRILE	02-08-151	140 mm / 5½"





1/2
CRILE
02-08-144
140 mm
5½"

		Artikel-Nr. Cat. No.	TITAN Artikel-Nr. Cat. No.	Gesamtlänge Total length
1/1	CRILE	02-08-144	02-08-144T	140 mm / 5½"
1/1	CRILE	02-08-145	02-08-145T	140 mm / 5½"
1/1	CRILE	02-08-154		140 mm / 5½"
1/1	CRILE	02-08-155		140 mm / 5½"

Artikel-Nr. Cat. No.	Gesamtlänge Total length		
02-08-166	160 mm / 6¼"	CRILE	1/1 
02-08-167	160 mm / 6¼"	CRILE	1/1 
02-08-176	160 mm / 6¼"	CRILE	1/1 
02-08-177	160 mm / 6¼"	CRILE	1/1 



1/2
CRILE
02-08-166
160 mm
6¼"

Artikel-Nr. Cat. No.	Gesamtlänge Total length		
02-08-168	160 mm / 6¼"	DIXON- LOVELACE	1/1 
02-08-178	160 mm / 6¼"	DIXON- LOVELACE	1/1 







1/2
DIXON-LOVELACE
02-08-178
160 mm
6¼"





1/2
LERICHE
02-08-160
150 mm
6"







		Artikel-Nr. Cat. No.	Gesamtlänge Total length
1/1		LERICHE 02-08-160	150 mm / 6"
1/1		LERICHE 02-08-161	150 mm / 6"
1/1		LERICHE 02-08-170	150 mm / 6"
1/1		LERICHE 02-08-171	150 mm / 6"









1/2
RANKIN
02-08-164
160 mm
6 1/4"

		Artikel-Nr. Cat. No.	Gesamtlänge Total length
1/1		RANKIN 02-08-164	160 mm / 6 1/4"
1/1		RANKIN 02-08-165	160 mm / 6 1/4"



Artikel-Nr. Cat. No.	Gesamtlänge Total length			
02-08-412	130 mm / 5 1/8"	PEAN	1/1	
	fein delicate			
02-08-413	130 mm / 5 1/8"	PEAN	1/1	
	fein delicate			
02-08-414	140 mm / 5 1/2"	PEAN	1/1	
	fein delicate			
02-08-415	140 mm / 5 1/2"	PEAN	1/1	
	fein delicate			
02-58-416	160 mm / 6 1/4"	PEAN	1/1	
	fein delicate			
02-58-417	160 mm / 6 1/4"	PEAN	1/1	
	fein delicate			

1/2
PEAN
02-08-414
140 mm
5 1/2"

Artikel-Nr. Cat. No.	Gesamtlänge Total length			
02-08-612	130 mm / 5 1/8"	KOCHER	1/1	
	fein delicate			
02-08-613	130 mm / 5 1/8"	KOCHER	1/1	
	fein delicate			
02-08-614	140 mm / 5 1/2"	KOCHER	1/1	
	fein delicate			
02-08-615	140 mm / 5 1/2"	KOCHER	1/1	
	fein delicate			
02-58-616	160 mm / 6 1/4"	KOCHER	1/1	
	fein delicate			
02-58-617	160 mm / 6 1/4"	KOCHER	1/1	
	fein delicate			

1/2
KOCHER
02-08-614
140 mm
5 1/2"



1/2
ROCHESTER-PEAN
02-08-444
 180 mm
 7"

		Artikel-Nr. Cat. No.	Gesamtlänge Total length
1/1	ROCHESTER-PEAN	02-08-424	140 mm / 5½"
1/1	ROCHESTER-PEAN	02-08-442	160 mm / 6¼"
1/1	ROCHESTER-PEAN	02-08-444	180 mm / 7"
1/1	ROCHESTER-PEAN	02-08-446	200 mm / 8"
1/1	ROCHESTER-PEAN	02-08-448	220 mm / 8¾"
1/1	ROCHESTER-PEAN	02-08-450	240 mm / 9½"
1/1	ROCHESTER-PEAN	02-08-472	260 mm / 10¼"
1/1	ROCHESTER-PEAN	02-08-474	300 mm / 12"



Artikel-Nr. Cat. No.	Gesamtlänge Total length		
02-08-425	140 mm / 5½"	ROCHESTER- PEAN	1/1
02-08-443	160 mm / 6¼"	ROCHESTER- PEAN	1/1
02-08-445	180 mm / 7"	ROCHESTER- PEAN	1/1
02-08-447	200 mm / 8"	ROCHESTER- PEAN	1/1
02-08-449	220 mm / 8¾"	ROCHESTER- PEAN	1/1
02-08-451	240 mm / 9½"	ROCHESTER- PEAN	1/1
02-08-473	260 mm / 10¼"	ROCHESTER- PEAN	1/1
02-08-475	300 mm / 12"	ROCHESTER- PEAN	1/1











1/2
ROCHESTER-PEAN
02-08-445
180 mm
7"











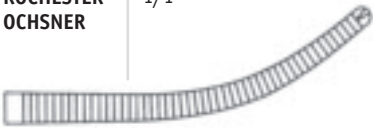

1/2
ROCHESTER-OCHSNER
02-08-644
180 mm
7"

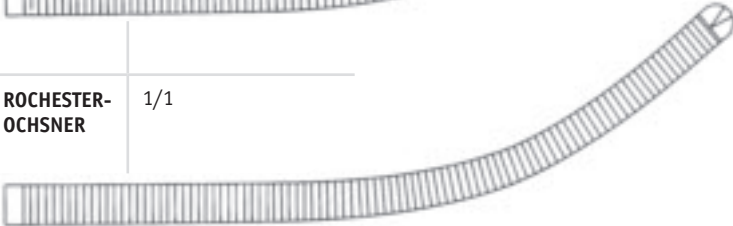

			Artikel-Nr. Cat. No.	Gesamtlänge Total length
	1/1	ROCHESTER-OCHSNER	02-08-618	140 mm / 5½"
				
	1/1	ROCHESTER-OCHSNER	02-08-642	160 mm / 6¼"
				
	1/1	ROCHESTER-OCHSNER	02-08-644	180 mm / 7"
				
	1/1	ROCHESTER-OCHSNER	02-08-646	200 mm / 8"
				
	1/1	ROCHESTER-OCHSNER	02-08-648	220 mm / 8¾"
				
	1/1	ROCHESTER-OCHSNER	02-08-650	240 mm / 9½"
				
	1/1	ROCHESTER-OCHSNER	02-08-652	260 mm / 10¼"
				
	1/1	ROCHESTER-OCHSNER	02-08-654	300 mm / 12"
				

Artikel-Nr. Cat. No.	Gesamtlänge Total length	ROCHESTER- OCHSNER	1/1
02-08-619	140 mm / 5½"		
02-08-643	160 mm / 6¼"		
02-08-645	180 mm / 7"		
02-08-647	200 mm / 8"		
02-08-649	220 mm / 8¾"		
02-08-651	240 mm / 9½"		
02-08-653	260 mm / 10¼"		
02-08-655	300 mm / 12"		



1/2
ROCHESTER-OCHSNER
02-08-645
180 mm
7"





1/2
MICRO-ADSON
02-10-008
 140 mm
 5½"

		Artikel-Nr. Cat. No.	Gesamtlänge Total length
1/1	MICRO-ADSON	02-10-008	140 mm / 5½"



1/2
BABY-MIXTER
02-10-011
 140 mm
 5½"

		Artikel-Nr. Cat. No.	Gesamtlänge Total length
1/1	BABY-MIXTER	02-10-011	140 mm / 5½"
1/1	BABY-MIXTER	02-10-012	180 mm / 7"



Artikel-Nr. Cat. No.	Gesamtlänge Total length		
02-10-100	130 mm / 5 1/8"	GEMINI	1/1
02-10-102	180 mm / 7"	GEMINI	1/1
02-10-103	200 mm / 8"	GEMINI	1/1
02-10-104	230 mm / 9"	GEMINI	1/1
02-10-106	280 mm / 11"	GEMINI	1/1

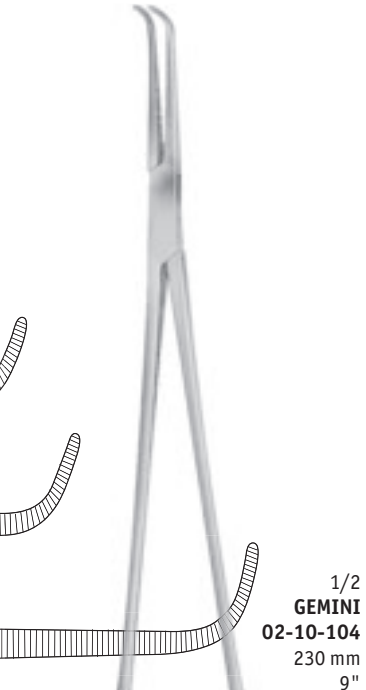

1/2
GEMINI
02-10-104
230 mm
9"

Artikel-Nr. Cat. No.	Gesamtlänge Total length		
02-10-020	195 mm / 7 3/4"	OVERHOLT- GEISSEN- DOERFER	1/1
02-10-021	210 mm / 8 1/4"	OVERHOLT- GEISSEN- DOERFER	1/1
02-10-022	220 mm / 8 3/4"	OVERHOLT- GEISSEN- DOERFER	1/1
02-10-023	225 mm / 9"	OVERHOLT- GEISSEN- DOERFER	1/1
02-10-024	210 mm / 8 1/4"	OVERHOLT- GEISSEN- DOERFER	1/1
02-10-025	230 mm / 9"	OVERHOLT- GEISSEN- DOERFER	1/1
02-10-026	225 mm / 9"	OVERHOLT- GEISSEN- DOERFER	1/1



1/2
OVERHOLT-
GEISSEN-
DOERFER
02-10-020
195 mm
7 3/4"



1/2
02-56-467
 160 mm
 6¼"



	Artikel-Nr. Cat. No.	Gesamtlänge Total length
1/1	02-56-463	90 mm / 3½"
	02-56-464	100 mm / 4"
	02-06-465	110 mm / 4¼"
	02-06-464	130 mm / 5"
	02-56-466	140 mm / 5½"
	02-56-467	160 mm / 6¼"
		für Papierabdeckung for paper clothes



1/2
02-06-466
 130 mm
 5"

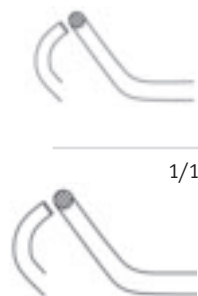





	Artikel-Nr. Cat. No.	Gesamtlänge Total length
1/1	02-56-465	100 mm / 4" stumpf blunt
1/1	02-06-466	130 mm / 5" stumpf blunt



Artikel-Nr. Cat. No.	Gesamtlänge Total length		
02-06-431	90 mm / 3½"	BACKHAUS	1/1
02-06-432	110 mm / 4¾"		
02-06-433	135 mm / 5¼"		
02-56-434	150 mm / 6"		

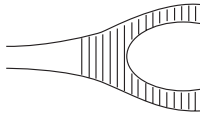

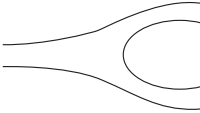
1/2
BACKHAUS
02-06-432
110 mm
4¾"

Artikel-Nr. Cat. No.	Gesamtlänge Total length		
02-06-112	180 mm / 7"	FOERSTER	1/1
02-56-114	200 mm / 8"		
02-06-122	240 mm / 9½"		
	gerade straight		
02-06-113	180 mm / 7"	FOERSTER	1/1
02-56-115	200 mm / 8"		
02-06-123	240 mm / 9½"		
	gebogen curved		
02-56-116	180 mm / 7"	FOERSTER	1/1
02-56-117	200 mm / 8"		
02-06-120	240 mm / 9½"		
	gerade straight		
02-56-118	180 mm / 7"	FOERSTER	1/1
02-56-119	200 mm / 8"		
02-06-121	240 mm / 9½"		
	gebogen curved		



1/2
FOERSTER
02-06-112
180 mm
7"



1/1

DE MARTEL
Artikel-Nr.
Cat. No.
06-06-010**06-06-011**
Gesamtlänge
Total length

135 mm / 5¼"

185 mm / 7¼"

 Kopfhautklemme, leicht gebogen
scalp flap forceps, slightly curved

 1/2
DE MARTEL
06-06-010
 135 mm
 5¼"

1/1

DANDY
Artikel-Nr.
Cat. No.
02-08-139
Gesamtlänge
Total length

140 mm / 5½"

 seitwärts gebogen
curved to side

1/1

DANDY**02-08-143**

140 mm / 5½"

 seitwärts gebogen
curved to side

1/1

MOYNIHAN**02-08-126**

145 mm / 5¾"





 seitwärts gebogen
curved to side

 1/2
DANDY
02-08-139
 140 mm
 5½"

Area with horizontal lines for notes.





Folgende Hartmetalleinlagen werden für REBSTOCK TC Nadelhalter verwendet:
 The REBSTOCK TC needle holders are equipped with the following tungsten carbide inserts

		TC	
		Teilung Structure	empfohlen für Nahtmaterial recommended for suture material
	normal regular	0,5 mm	>3/0
	mini mini	0,4 mm	4/0 - 6/0
	mikro micro	0,3 mm	5/0 - 8/0
	glatt smooth	-	7/0 - 10/0





TC

Artikel-Nr. Cat. No.	Artikel-Nr. Cat. No.	Gesamtlänge Total length		
02-13-200		125 mm / 5"	CONVERSE	1/1 
02-13-204		125 mm / 5"	DERF	1/1 
	02-13-008	125 mm / 5"	DERF	1/1 0,4 mm 





1/2
DERF
02-13-204
125 mm
5"

Artikel-Nr. Cat. No.		Gesamtlänge Total length		
02-13-201	glattes Maul smooth jaw	130 mm / 5 1/8"	HALSEY	1/1 
02-13-205		130 mm / 5 1/8"	HALSEY	1/1 



1/2
HALSEY
02-13-205
130 mm
5 1/8"

TC



Artikel-Nr. Cat. No.		Gesamtlänge Total length		
02-13-010	glattes Maul smooth jaw	120 mm / 4 3/4"	HALSEY	1/1 
02-13-012		130 mm / 5 1/8"	HALSEY	1/1 0,4 mm 
02-13-011		130 mm / 5 1/8"	CONVERSE	1/1 0,4 mm 



1/2
HALSEY
02-13-010
120 mm
4 3/4"



 1/2
WEBSTER
02-13-202
 130 mm
 5 1/8"

		TC		
	Artikel-Nr. Cat. No.	Artikel-Nr. Cat. No.	Gesamtlänge Total length	
1/1 	WEBSTER	02-63-202	115 mm / 4 1/2"	
		02-13-202	130 mm / 5 1/8"	
1/1 	WEBSTER	02-63-014	120 mm / 4 3/4"	
		02-13-014	130 mm / 5 1/8"	
1/1 0,4 mm 	WEBSTER	02-13-024	125 mm / 5"	



 1/2
BAUMGARTNER
02-13-015
 140 mm
 5 1/2"

		TC		
	Artikel-Nr. Cat. No.	Artikel-Nr. Cat. No.	Gesamtlänge Total length	
1/1 0,5 mm 	BAUMGARTNER	02-63-016	125 mm / 5"	
		02-13-015	140 mm / 5 1/2"	









		TC		
	Artikel-Nr. Cat. No.	Artikel-Nr. Cat. No.	Gesamtlänge Total length	
1/1 0,5 	KILNER	02-13-018	135 mm / 5 1/4"	

 1/2
KILNER
02-13-018
 135 mm
 5 1/4"

Artikel-Nr. Cat. No.	Gesamtlänge Total length		
02-13-218	150 mm / 6"	CRILE- WOOD	1/1
02-63-220	180 mm / 7"		
02-63-221	200 mm / 8"		



1/2
CRILE-WOOD
02-13-218
150 mm
6"

TC				
Artikel-Nr. Cat. No.	Gesamtlänge Total length			
02-13-013	150 mm / 6"	BABY CRILE- WOOD	1/1 0,4 mm	
02-13-016	145 mm / 5 3/4"	CRILE- WOOD	1/1 0,4 mm	
02-63-013	150 mm / 6" für Linkshänder for left-handed	CRILE- WOOD	1/1 0,4 mm	
02-13-017	180 mm / 7"	CRILE- WOOD	1/1 0,4 mm	
02-13-019	200 mm / 8"	CRILE- WOOD	1/1 0,4 mm	
02-13-021	305 mm / 12 1/2"	CRILE- WOOD	1/1 0,4 mm	



1/2
CRILE-WOOD
02-13-019
200 mm
8"









 1/2
DE BAKEY
02-13-033
 165 mm
 6½"

 1/2
DE BAKEY
02-13-025
 180 mm
 7"







TC

		Artikel-Nr. Cat. No.	Gesamtlänge Total length
1/1 0,4 mm	DE BAKEY	02-13-033	165 mm / 6½"
		02-13-034	210 mm / 8¼"
			<i>schlankes Modell delicate pattern</i>

TC









		Artikel-Nr. Cat. No.	Gesamtlänge Total length
1/1 0,3 mm	DE BAKEY	02-63-024	160 mm / 6¼"
			<i>schlankes Modell delicate pattern</i>
1/1 0,3 mm	DE BAKEY	02-13-025	180 mm / 7"
			<i>schlankes Modell delicate pattern</i>
1/1 0,3 mm	DE BAKEY	02-13-026	210 mm / 8¼"
			<i>schlankes Modell delicate pattern</i>
1/1 0,3 mm	DE BAKEY	02-13-027	230 mm / 9"
			<i>schlankes Modell delicate pattern</i>
1/1 0,4 mm	DE BAKEY	02-13-040	310 mm / 12½"
			<i>schlankes Modell delicate pattern</i>

TC

Artikel-Nr. Cat. No.	Gesamtlänge Total length		
02-13-032	150 mm / 6"	DE BAKEY	1/1 0,4 mm 
02-13-035	180 mm / 7"	DE BAKEY	1/1 0,4 mm 
02-63-035	200 mm / 8"	DE BAKEY	1/1 0,4 mm 
02-13-036	230 mm / 9"	DE BAKEY	1/1 0,4 mm 
02-13-037	250 mm / 10"	DE BAKEY	1/1 0,4 mm 
02-13-038	300 mm / 12"	DE BAKEY	1/1 0,4 mm 
02-63-039	370 mm / 14¾"	DE BAKEY	1/1 0,4 mm 



1/2
DE BAKEY
02-13-035
180 mm
7"









Artikel-Nr. Cat. No.	Gesamtlänge Total length		
02-63-064	140 mm / 5½"	MAYO-HEGAR	1/1 0,5 mm 
02-13-065	150 mm / 6"	MAYO-HEGAR	1/1 0,5 mm 
02-13-066	180 mm / 7"	MAYO-HEGAR	1/1 0,5 mm 
02-13-067	200 mm / 8"	MAYO-HEGAR	1/1 0,5 mm 
02-13-068	240 mm / 9½"	MAYO-HEGAR	1/1 0,5 mm 
02-13-070	260 mm / 10¼"	MAYO-HEGAR	1/1 0,5 mm 
02-13-069	300 mm / 12"	MAYO-HEGAR	1/1 0,5 mm 
02-63-069	160 mm / 6¼"	MAYO-HEGAR	1/1 
02-63-070	180 mm / 7"	MAYO-HEGAR	1/1 
	glattes Maul smooth jaw		



1/2
MAYO-HEGAR
02-13-067
200 mm
8"

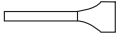

1/2
RYDER
02-63-046
 230 mm
 9"

		TC	
		Artikel-Nr. Cat. No.	Gesamtlänge Total length
1/1 0,4 mm	RYDER	02-13-044 02-63-044	135 mm / 5¼" 150 mm / 6"
			
1/1 0,4 mm	RYDER	02-13-045	180 mm / 7"
			
1/1 0,4 mm	RYDER	02-13-046 02-63-046	200 mm / 8" 230 mm / 9"
			
1/1 0,4 mm	RYDER	02-13-047	265 mm / 10½"
			
1/1	RYDER	02-63-047	135 mm / 5¼" glattes Maul smooth jaw
			
1/1	RYDER	02-13-074	150 mm / 6" glattes Maul smooth jaw
			
1/1	RYDER	02-13-075	180 mm / 7" glattes Maul smooth jaw
			
1/1	RYDER	02-63-075	200 mm / 8" glattes Maul smooth jaw
			
1/1	RYDER	02-13-076	230 mm / 9" glattes Maul smooth jaw
			

TC

Artikel-Nr.
Cat. No.

Gesamtlänge
Total length

02-13-020	175 mm / 7"	SAROT	1/1 0,5 mm
02-13-023	260 mm / 10¼"	SAROT	1/1 0,5 mm



1/2
SAROT
02-13-020
175 mm
7"





1/2
02-20-123
 160 mm
 6¼"



		Artikel-Nr. Cat. No.	Gesamtlänge Total length
1/1		02-20-121	160 mm / 6¼" scharf sharp
1/1		02-20-122	160 mm / 6¼" scharf sharp
1/1		02-20-123	160 mm / 6¼" scharf sharp
1/1		02-20-124	160 mm / 6¼" scharf sharp



1/2
02-20-128
 160 mm
 6¼"

		Artikel-Nr. Cat. No.	Gesamtlänge Total length
1/1		02-20-126	160 mm / 6¼" stumpf blunt
1/1		02-20-127	160 mm / 6¼" stumpf blunt
1/1		02-20-128	160 mm / 6¼" stumpf blunt
1/1		02-20-129	160 mm / 6¼" stumpf blunt



Artikel-Nr. Cat. No.	Gesamtlänge Total length		
15-01-334	160 mm / 6¼"	GUTHRIE	1/1 
15-01-335	160 mm / 6¼"	GUTHRIE	1/1 

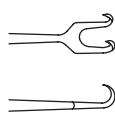
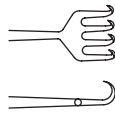
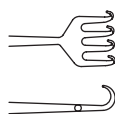

1/2
GUTHRIE
15-01-334
160 mm
6¼"

Artikel-Nr. Cat. No.	Gesamtlänge Total length		
15-01-336	130 mm / 5½"	ROLLET	1/1 
15-01-337	130 mm / 5½"	ROLLET	1/1 
15-01-338	130 mm / 5½"	ROLLET	1/1 







1/2
ROLLET
15-01-336
130 mm
5½"









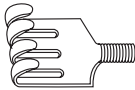

2/3
02-20-133
 160 mm
 6¼"

		Artikel-Nr. Cat. No.	Gesamtlänge Total length
1/1		02-20-132	160 mm / 6¼" flexibel, scharf <i>flexible, sharp</i>
1/1		02-20-133	160 mm / 6¼" flexibel, scharf <i>flexible, sharp</i>
1/1		02-20-134	160 mm / 6¼" flexibel, scharf <i>flexible, sharp</i>

		Artikel-Nr. Cat. No.	Gesamtlänge Total length
1/1		02-20-136	160 mm / 6¼" flexibel, stumpf <i>flexible, blunt</i>
1/1		02-20-137	160 mm / 6¼" flexibel, stumpf <i>flexible, blunt</i>
1/1		02-20-138	160 mm / 6¼" flexibel, stumpf <i>flexible, blunt</i>

Artikel-Nr. Cat. No.	Gesamtlänge Total length	MEYERDING	
02-20-193	180 mm / 7"	MEYERDING	1/1 18 x 7 mm 
02-20-194	180 mm / 7"	MEYERDING	1/1 16 x 5 mm 
02-20-195	180 mm / 7"	MEYERDING	1/1 7 x 4 mm 

Artikel-Nr. Cat. No.	Gesamtlänge Total length	MEYERDING	
02-20-196	180 mm / 7"	MEYERDING	1/1 5 x 10 mm 
02-20-197	180 mm / 7"	MEYERDING	1/1 11 x 4 mm 
02-20-198	180 mm / 7"	MEYERDING	1/1 6 x 4 mm 



2/3
MEYERDING
02-20-193
180 mm
7"











1/2
RAGNELL
02-20-004
 150 mm
 6"

		Artikel-Nr. Cat. No.	Gesamtlänge Total length
	RAGNELL	02-20-004	150 mm / 6"



1/2
SENN-MILLER
02-20-008
 160 mm
 6¼"

		Artikel-Nr. Cat. No.	Gesamtlänge Total length
1/1	SENN-MILLER	02-70-002	160 mm / 6¼" stumpf blunt
1/1	SENN-MILLER	02-20-008	160 mm / 6¼" scharf sharp

Artikel-Nr. Cat. No.	Gesamtlänge Total length		
02-70-180	205 mm / 8"	CUSHING	1/1 8 mm
02-70-181	240 mm / 9½"		
02-20-184	205 mm / 8"	CUSHING	1/1 10 mm
02-70-182	240 mm / 9½"		
02-70-184	205 mm / 8"	CUSHING	1/1 12 mm
02-70-183	240 mm / 9½"		
02-20-185	205 mm / 8"	CUSHING	1/1 14 mm
02-70-187	240 mm / 9½"		
02-70-185	205 mm / 8"	CUSHING	1/1 16 mm
02-70-188	240 mm / 9½"		
02-70-186	205 mm / 8"	CUSHING	1/1 18 mm
02-70-189	240 mm / 9½"		



2/3
CUSHING
02-20-184
205 mm
8"







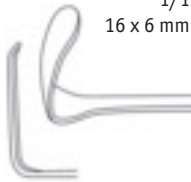
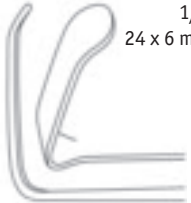

2/3
LANGENBECK-GREEN
02-20-177
 160 mm
 6¼"

		Artikel-Nr. Cat. No.	Gesamtlänge Total length	
	1/1 16 x 6 mm	LANGEN- BECK- GREEN	02-20-177	160 mm / 6¼"
	1/1 24 x 6 mm	LANGEN- BECK- GREEN	02-20-178	160 mm / 6¼"



2/3
DESMARRES
15-01-310
 140 mm
 5½"

		Artikel-Nr. Cat. No.	Gesamtlänge Total length	
	1/1 9 x 9 mm	DESMARRES	15-01-310	140 mm / 5½"
	1/1 9 x 12 mm	DESMARRES	15-01-311	140 mm / 5½"
	1/1 11 x 14 mm	DESMARRES	15-01-312	140 mm / 5½"
	1/1 12 x 16 mm	DESMARRES	15-01-313	140 mm / 5½"
	1/1 13 x 18 mm	DESMARRES	15-01-314	140 mm / 5½"



Artikel-Nr. Cat. No.	Gesamtlänge Total length		
02-70-770	240 mm / 9½"	Sattelhäkchen, biegsamer Schaft <i>saddle hook, malleable shaft</i>	GIL VERNET 1/1 4 mm 
02-70-778	240 mm / 9½"	Sattelhäkchen, biegsamer Schaft <i>saddle hook, malleable shaft</i>	GIL VERNET 1/1 6 mm 
02-70-771	240 mm / 9½"	Sattelhäkchen, biegsamer Schaft <i>saddle hook, malleable shaft</i>	GIL VERNET 1/1 8 mm 
02-70-772	240 mm / 9½"	Sattelhäkchen, biegsamer Schaft <i>saddle hook, malleable shaft</i>	GIL VERNET 1/1 11 mm 
02-70-773	240 mm / 9½"	Sattelhäkchen, biegsamer Schaft <i>saddle hook, malleable shaft</i>	GIL VERNET 1/1 13 mm 
02-70-774	240 mm / 9½"	Sattelhäkchen, biegsamer Schaft <i>saddle hook, malleable shaft</i>	GIL VERNET 1/1 15 mm 
02-70-775	240 mm / 9½"	Sattelhäkchen, biegsamer Schaft <i>saddle hook, malleable shaft</i>	GIL VERNET 1/1 17 mm 
02-70-776	240 mm / 9½"	Sattelhäkchen, biegsamer Schaft <i>saddle hook, malleable shaft</i>	GIL VERNET 1/1 20 mm 
02-70-777	240 mm / 9½"	Sattelhäkchen, biegsamer Schaft <i>saddle hook, malleable shaft</i>	GIL VERNET 1/1 23 mm 





1/2
GIL VERNET
02-70-776
240 mm
9½"







2/3
MANNERFELT mod.
02-20-918
 155 mm
 6"





			Artikel-Nr. Cat. No.	Gesamtlänge Total length
1/1	MANNER- FELT mod.		02-20-911	155 mm / 6" enge Biegung, scharf <i>small curve, sharp</i>
1/1	MANNER- FELT mod.		02-20-912	155 mm / 6" enge Biegung, scharf <i>small curve, sharp</i>
1/1	MANNER- FELT mod.		02-20-913	155 mm / 6" enge Biegung, scharf <i>small curve, sharp</i>





			Artikel-Nr. Cat. No.	Gesamtlänge Total length
1/1	MANNER- FELT mod.		02-20-916	155 mm / 6" enge Biegung, stumpf <i>small curve, blunt</i>
1/1	MANNER- FELT mod.		02-20-917	155 mm / 6" enge Biegung, stumpf <i>small curve, blunt</i>
1/1	MANNER- FELT mod.		02-20-918	155 mm / 6" enge Biegung, stumpf <i>small curve, blunt</i>



Artikel-Nr. Cat. No.	Gesamtlänge Total length		
02-20-921	155 mm / 6" weite Biegung, scharf large curve, sharp	MANNER- FELT mod.	1/1 
02-20-922	155 mm / 6" weite Biegung, scharf large curve, sharp	MANNER- FELT mod.	1/1 
02-20-923	155 mm / 6" weite Biegung, scharf large curve, sharp	MANNER- FELT mod.	1/1 



Artikel-Nr. Cat. No.	Gesamtlänge Total length		
02-20-926	155 mm / 6" weite Biegung, stumpf large curve, blunt	MANNER- FELT mod.	1/1 
02-20-927	155 mm / 6" weite Biegung, stumpf large curve, blunt	MANNER- FELT mod.	1/1 
02-20-928	155 mm / 6" weite Biegung, stumpf large curve, blunt	MANNER- FELT mod.	1/1 



2/3
MANNERFELT mod.
02-20-928
155 mm
6"







1/1
LANGENBECK
MANNERFELT mod.
02-20-945
 155 mm
 6"

		Artikel-Nr. Cat. No.	Gesamtlänge Total length
	1/1 16 x 6 mm	02-20-940	155 mm / 6" hohlgekehrt hollow grooved
	1/1 15 x 6 mm	02-20-943	155 mm / 6"
	1/1 20 x 6 mm	02-20-944	155 mm / 6"
	1/1 25 x 6 mm	02-20-945	155 mm / 6"
	1/1 30 x 8 mm	02-20-946	155 mm / 6"



1/2
MANNERFELT mod.
02-20-949
 155 mm
 6"

		Artikel-Nr. Cat. No.	Gesamtlänge Total length
	1/1 12 x 12 mm	02-20-948	155 mm / 6" Sattelhaken saddle hook
	1/1 12 x 14 mm	02-20-949	155 mm / 6" Sattelhaken saddle hook
	1/1 14 x 16 mm	02-20-951	155 mm / 6" Sattelhaken saddle hook

Artikel-Nr. Cat. No.	Gesamtlänge Total length		
02-20-200	250 mm / 10"	CUSHING	1/1 11 x 14 mm 
02-20-201	250 mm / 10"	CUSHING	1/1 13 x 18 mm 
02-20-202	250 mm / 10"	CUSHING	1/1 15 x 22 mm 



Artikel-Nr. Cat. No.	Gesamtlänge Total length		
02-20-192	210 mm / 8¼" 6 x 13 mm	SCHOEN- BORN	



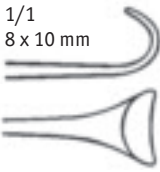





Artikel-Nr. Cat. No.	Gesamtlänge Total length		
02-70-190	215 mm / 8½"	CUSHING	1/1 8 x 10 mm 











1/2
VOLKMANN
02-20-244
 220 mm
 8 3/4"

		Artikel-Nr. Cat. No.	Gesamtlänge Total length
1/2	VOLKMANN	02-70-241	220 mm / 8 3/4"
			scharf sharp
1/2 9 x 8 mm	VOLKMANN	02-20-242	220 mm / 8 3/4"
			scharf sharp
1/2 9 x 13 mm	VOLKMANN	02-20-243	220 mm / 8 3/4"
			scharf sharp
1/2 9 x 19 mm	VOLKMANN	02-20-244	220 mm / 8 3/4"
			scharf sharp
1/2 9 x 29 mm	VOLKMANN	02-20-246	220 mm / 8 3/4"
			scharf sharp
1/2 9 x 40 mm	VOLKMANN	02-20-248	220 mm / 8 3/4"
			scharf sharp



Artikel-Nr. Cat. No.	Gesamtlänge Total length		
02-70-250	220 mm / 8¾"	VOLKMANN	1/2 
02-20-252	220 mm / 8¾"	VOLKMANN	1/2 9 x 8 mm 
02-20-253	220 mm / 8¾"	VOLKMANN	1/2 9 x 13 mm 
02-20-254	220 mm / 8¾"	VOLKMANN	1/2 9 x 19 mm 
02-20-256	220 mm / 8¾"	VOLKMANN	1/2 9 x 29 mm 
02-20-258	220 mm / 8¾"	VOLKMANN	1/2 9 x 40 mm 



1/2
VOLKMANN
02-20-254
220 mm
8¾"



1/2
VOLKMANN
02-20-260
 220 mm
 8¾"

		Artikel-Nr. Cat. No.	Gesamtlänge Total length
1/2	VOLKMANN	02-70-255	220 mm / 8¾" halbscharf semi-sharp
1/2 9 x 8 mm	VOLKMANN	02-20-257	220 mm / 8¾" halbscharf semi-sharp
1/2 9 x 13 mm	VOLKMANN	02-20-259	220 mm / 8¾" halbscharf semi-sharp
1/2 9 x 19 mm	VOLKMANN	02-20-260	220 mm / 8¾" halbscharf semi-sharp
1/2 9 x 29 mm	VOLKMANN	02-20-261	220 mm / 8¾" halbscharf semi-sharp
1/2 9 x 40 mm	VOLKMANN	02-20-265	220 mm / 8¾" halbscharf semi-sharp

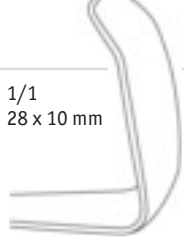

Artikel-Nr. Cat. No.	Gesamtlänge Total length	LANGEN- BECK	1/1 28 x 10 mm
02-20-320	210 mm / 8¼"		

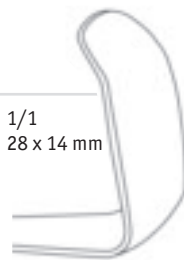
Artikel-Nr. Cat. No.	Gesamtlänge Total length	LANGEN- BECK	1/1 28 x 14 mm
02-20-321	210 mm / 8¼"		

Artikel-Nr. Cat. No.	Gesamtlänge Total length	LANGEN- BECK	1/1 28 x 16 mm
02-20-323	210 mm / 8¼"		

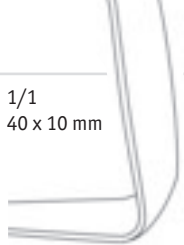
Artikel-Nr. Cat. No.	Gesamtlänge Total length	LANGEN- BECK	1/1 40 x 10 mm
02-20-325	210 mm / 8¼"		

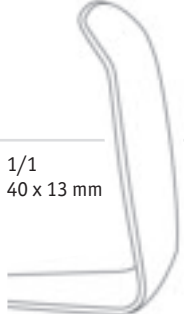
Artikel-Nr. Cat. No.	Gesamtlänge Total length	LANGEN- BECK	1/1 40 x 13 mm
02-20-326	210 mm / 8¼"		



1/2
LANGENBECK
02-20-321
210 mm
8¼"





1/1

MEYERDING

**Artikel-Nr.
Cat. No.**

02-20-485

**Gesamtlänge
Total length**

230 mm / 9"

 50 x 16 mm
 Laminektomie-Retractor
laminectomy retractor

1/1

MEYERDING

**Artikel-Nr.
Cat. No.**

02-20-486

**Gesamtlänge
Total length**

240 mm / 9"

 80 x 25 mm
 Laminektomie-Retractor
laminectomy retractor

 1/2
MEYERDING
02-20-485
 230 mm
 9"

1/1

MEYERDING

**Artikel-Nr.
Cat. No.**

02-20-487

**Gesamtlänge
Total length**

250 mm / 10"

 90 x 50 mm
 Laminektomie-Retractor
laminectomy retractor

Artikel-Nr. Cat. No.	Gesamtlänge Total length		
02-70-480	200 mm / 8" Blattbreite 18 mm width of blade 18 mm		
02-70-481	200 mm / 8" Blattbreite 20 mm width of blade 20 mm		
02-70-482	200 mm / 8" Blattbreite 23 mm width of blade 23 mm		



1/2
02-70-481
200 mm
8"

Artikel-Nr. Cat. No.	Gesamtlänge Total length		
02-70-270	185 mm / 7 1/4" 30 x 80 mm Spinal Retraktor spinal retractor	TAYLOR	
02-70-271	185 mm / 7 1/4" 30 x 100 mm Spinal Retraktor spinal retractor	TAYLOR	



1/2
TAYLOR
02-70-270
185 mm
7 1/4"





1/3
HIBBS
02-70-272
 240 mm
 9½"

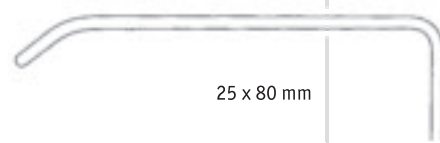

25 x 80 mm

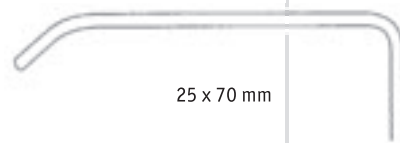

25 x 70 mm

	Artikel-Nr. Cat. No.	Gesamtlänge Total length
HIBBS	02-70-273	240 mm / 9½"
HIBBS	02-70-274	240 mm / 9½"
HIBBS	02-70-272	Paar bestehend aus: pair consisting of: 02-70-273 - 02-70-274

Area with horizontal lines for notes.





1/3
YANKAUER-BABY
07-56-943
 220 mm
 8¾"

		Artikel-Nr. Cat. No.	Gesamtlänge Total length
	YANKAUER-BABY	07-56-943	220 mm / 8¾"



1/3
YANKAUER
07-06-944
 285 mm
 11¼"

		Artikel-Nr. Cat. No.	Gesamtlänge Total length
	YANKAUER	07-06-944	285 mm / 11¼" mit zentraler Bohrung ø 2 mm with central nub ø 2 mm
	YANKAUER	15-13-671	285 mm / 11¼" mit zentraler Bohrung ø 4,8 mm with central nub ø 4.8 mm



Artikel-Nr. Cat. No.	Gesamtlänge Total length		
07-56-945	270 mm / 10 ³ / ₄ "	YANKAUER	
	komplett mit Saugspitze und Schlaucholive <i>complete with suction tip and olive</i>		
07-56-946	Saugspitze <i>suction tip</i>		
07-56-947	Schlaucholive <i>olive</i>		



1/3
YANKAUER
07-56-945
270 mm
10³/₄"

Artikel-Nr. Cat. No.	Gesamtlänge Total length		
07-56-948	320 mm / 12 ¹ / ₂ " ø 10 mm (30 Charr.)	WALTON YANKAUER	
	mit Absperrventil und abschraubbarem Rohr <i>with stopcock and tube to be screwed off</i>		



1/3
**WALTON
YANKAUER**
07-56-948
320 mm
12¹/₂"

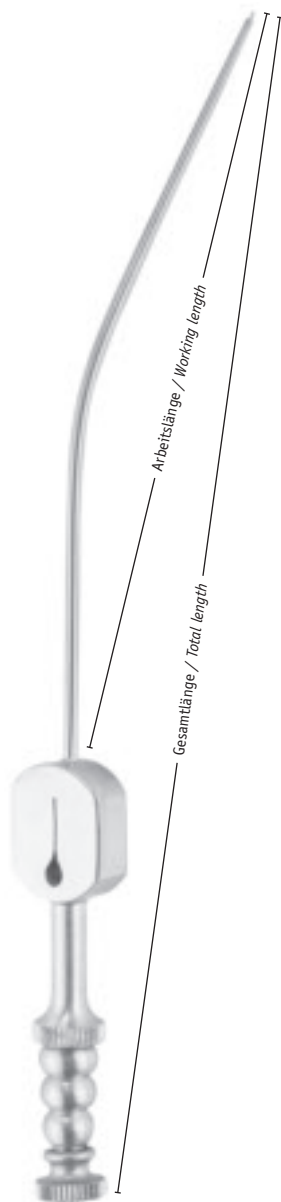

Arbeitslänge
Working Length

 100 mm
 4"

 115 mm
 4½"

 140 mm
 5½"

 165 mm
 6½"

Gesamtlänge
Total Length

 165 mm
 6½"

 180 mm
 7"

 205 mm
 8"

 230 mm
 9"

Ø

○	3 Fr / 1,0 mm	07-06-401	07-06-391	07-06-411	07-06-421
○	4 Fr / 1,4 mm	07-06-402	07-06-392	07-06-412	07-06-422
○	5 Fr / 1,7 mm	07-06-403	07-06-393	07-06-413	07-06-423
○	6 Fr / 2,0 mm	07-06-404	07-06-394	07-06-414	07-06-424
○	7 Fr / 2,3 mm	07-06-405	07-06-395	07-06-415	07-06-425
○	8 Fr / 2,7 mm	07-06-406	07-06-396	07-06-416	07-06-426
○	9 Fr / 3,0 mm	07-06-407	07-06-397	07-06-417	07-06-427
○	12 Fr / 4,0 mm	07-06-409	07-06-399	07-06-419	07-06-429

 1/1
07-06-401
 100 mm
 4"

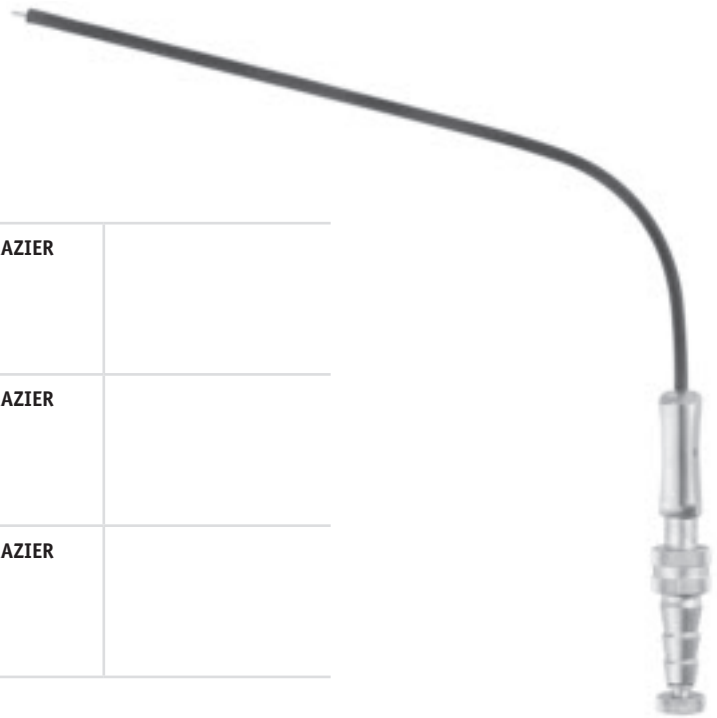

Artikel-Nr. Cat. No.	Gesamtlänge Total length		
07-56-909	190 mm / 7½" 7 Charr., ø 2,3 mm isoliert <i>insulated</i>	FRAZIER	
07-56-910	190 mm / 7½" 9 Charr., ø 3,0 mm isoliert <i>insulated</i>	FRAZIER	
07-56-911	190 mm / 7½" 11 Charr., ø 3,7 mm isoliert <i>insulated</i>	FRAZIER	

1/2
FRAZIER
07-56-909
190 mm
7½"

Artikel-Nr. Cat. No.	Gesamtlänge Total length		
07-06-933	180 mm / 7" ø 4 mm Schlaucholive ø 6-9 mm, isoliert <i>olive ø 6-9 mm, insulated</i>	FERGUSSON	



1/2
FERGUSSON
07-06-933
180 mm
7¼"





1/2
FRAZIER
07-06-930
 180 mm
 7¼"

Artikel-Nr.
Cat. No.
Gesamtlänge
Total length

	FRAZIER	
		180 mm / 7¼"
	07-06-927	F.G. Charr. 6, ø 2,0 mm, 30°
	07-56-927	F.G. Charr. 7, ø 2,3 mm, 30°
	07-06-928	F.G. Charr. 8, ø 2,7 mm, 30°
	07-06-923	F.G. Charr. 9, ø 3,0 mm, 30°
	07-56-930	F.G. Charr. 10, ø 3,3 mm, 30°
	07-56-931	F.G. Charr. 11, ø 3,7 mm, 30°
	07-06-930	F.G. Charr. 12, ø 4,0 mm, 30°
	07-06-931	F.G. Charr. 15, ø 5,0 mm, 30°
		Saugkanülen mit Unterbrecher und Mandrin
		<i>suction cannulae with finger cut-off and stylet</i>

Artikel-Nr.
Cat. No.
Gesamtlänge
Total length

	FRAZIER	
		180 mm / 7¼"
	07-56-933	F.G. Charr. 6, ø 2,0 mm, 75°
	07-56-934	F.G. Charr. 7, ø 2,3 mm, 75°
	07-56-935	F.G. Charr. 8, ø 2,7 mm, 75°
	07-56-936	F.G. Charr. 9, ø 3,0 mm, 75°
	07-56-937	F.G. Charr. 10, ø 3,3 mm, 75°
	07-56-938	F.G. Charr. 11, ø 3,7 mm, 75°
	07-56-939	F.G. Charr. 12, ø 4,0 mm, 75°
	07-56-940	F.G. Charr. 15, ø 5,0 mm, 75°
		Saugkanülen mit Unterbrecher und Mandrin
		<i>suction cannulae with finger cut-off and stylet</i>

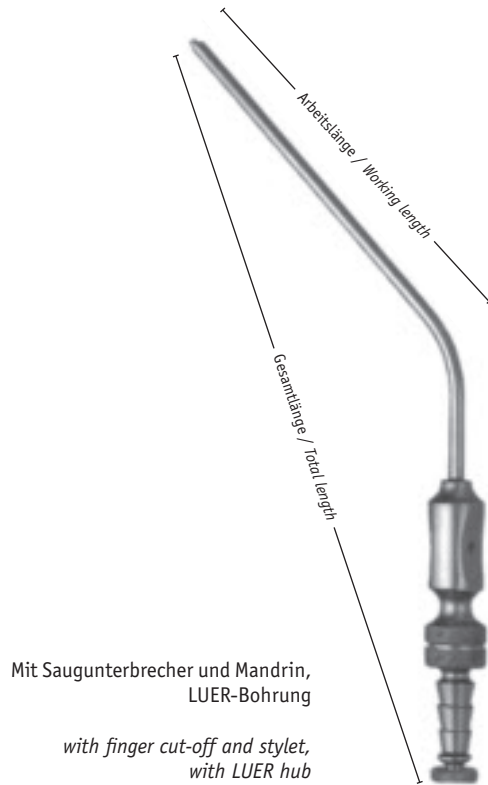

1/2
FRAZIER
(FERGUSSON)
07-06-354
110 mm
4 3/8"

Arbeitslänge <i>Working Length</i>	110 mm 4 3/8"	130 mm 5 1/8"	160 mm 6 3/8"	200 mm 8"
Gesamtlänge <i>Total Length</i>	195 mm 7 3/4"	215 mm 8 1/2"	245 mm 9 3/4"	280 mm 11"

∅

1,5 mm	07-06-350	07-06-360	07-06-370	07-06-380
2,0 mm	07-06-351	07-06-361	07-06-371	07-06-381
2,5 mm	07-06-352	07-06-362	07-06-372	07-06-382
3,0 mm	07-06-353	07-06-363	07-06-373	07-06-383
4,0 mm	07-06-354	07-06-364	07-06-374	07-06-384
5,0 mm	07-06-355	07-06-365	07-06-375	07-06-385





1/3
ADSON
07-06-917
 210 mm
 8 3/4"

		Artikel-Nr. Cat. No.	Gesamtlänge Total length
	ADSON	07-06-917	210 mm / 8 3/4" ø 4 mm mit Saugunterbrecher und Mandrin <i>with finger cut-off and stylet</i>



1/2
FRAZIER
07-56-908
 200 mm
 8"

		Artikel-Nr. Cat. No.	Gesamtlänge Total length
	FRAZIER	07-56-904	200 mm / 8" ø 2 mm
		07-56-905	200 mm / 8" ø 2,3 mm
		07-56-906	200 mm / 8" ø 2,7 mm
		07-56-907	200 mm / 8" ø 3,3 mm
		07-56-908	200 mm / 8" ø 3,7 mm mit Saugunterbrecher und Mandrin <i>with finger cut-off and stylet</i>



Artikel-Nr. Cat. No.	Gesamtlänge Total length		
07-06-939	195 mm / 7¾" ø 1,5 mm	PLESTER	
07-06-940	195 mm / 7¾" ø 2,0 mm		
07-06-941	195 mm / 7¾" ø 2,5 mm		
07-06-942	195 mm / 7¾" ø 3,0 mm		
mit Saugunterbrecher und Mandrin, LUER-Bohrung with finger cut-off and stylet, LUER hub			



1/2
PLESTER
07-06-941
195 mm
7¾"

Artikel-Nr. Cat. No.	Gesamtlänge Total length		
07-56-915	130 mm / 5" ø 1,6 mm	POPPEN	
07-56-916	130 mm / 5" ø 2,0 mm		
07-56-917	130 mm / 5" ø 2,3 mm		
07-56-918	130 mm / 5" ø 2,7 mm		
07-56-919	130 mm / 5" ø 3,0 mm		
07-56-920	130 mm / 5" ø 3,3 mm		
07-56-921	130 mm / 5" ø 4,0 mm		
07-56-922	130 mm / 5" ø 5,0 mm		
mit Saugunterbrecher und Mandrin, LUER-Bohrung with finger cut-off and stylet, LUER hub			



2/3
POPPEN
07-56-921
130 mm
5"





1/2
LUER
15-12-183
 180 mm
 7"

		Artikel-Nr. Cat. No.	Gesamtlänge Total length
	LUER	15-12-183	180 mm / 7" ø 4,5 mm Schlaucholive ø 6-9 mm olive ø 6-9 mm
	LUER	15-12-185	180 mm / 7" ø 5,5 mm Schlaucholive ø 6-9 mm olive ø 6-9 mm



1/2
MAGILL
07-06-908
 245 mm
 9¾"

		Artikel-Nr. Cat. No.	Gesamtlänge Total length
	MAGILL	07-06-906	245 mm / 9¾" ø 3 mm / Fig. 1
	MAGILL	07-06-907	245 mm / 9¾" ø 3,5 mm / Fig. 2
	MAGILL	07-06-908	245 mm / 9¾" ø 4 mm / Fig. 3
	MAGILL	07-06-909	Mandrin stylet

Artikel-Nr. Cat. No.	Gesamtlänge Total length		
07-06-937	200 mm / 8" ø 2 mm	LEMPERT	
07-06-938	200 mm / 8" ø 3 mm		
mit Saugunterbrecher und Mandrin with finger cut-off and stylet			



1/2
LEMPERT
07-06-937
200 mm
8"

Artikel-Nr. Cat. No.	Gesamtlänge Total length		
07-06-980	200 mm / 8" ø 3,2 mm	LANDOLT	
Präpariersauger, bajonettförmig, scharf dissecting suction tube, bayonet-shaped, sharp			



1/2
LANDOLT
07-06-980
200 mm
8"



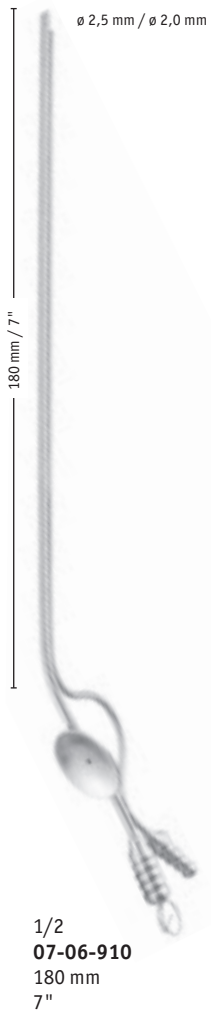

Artikel-Nr. Cat. No.	Arbeitslänge working length
07-06-910	180 mm / 7" Schlaucholive \varnothing 4,5 mm mit Saugunterbrecher und Mandrin <i>olive \varnothing 4.5 mm with finger cut-off and stylet</i>



Artikel-Nr. Cat. No.	Gesamtlänge Total length
YASARGIL 07-06-905	200 mm / 8" \varnothing 2,0 mm / 4,5 mm Saug- und Spülkanüle <i>suction and irrigation cannula</i>

Artikel-Nr. Cat. No.	Arbeitslänge working length		
07-06-911	90 mm / 3½" ø 0,9 mm / ø 0,7 mm	HOUSE	
07-06-912	90 mm / 3½" ø 1,2 mm / ø 0,9 mm		
07-06-913	90 mm / 3½" ø 1,5 mm / ø 1,2 mm		
07-56-890	90 mm / 3½" ø 1,8 mm / ø 1,8 mm		
07-56-891	90 mm / 3½" ø 2,0 mm / ø 2,0 mm		
07-56-892	90 mm / 3½" ø 3,0 mm / ø 2,0 mm		
07-56-893	90 mm / 3½" ø 4,5 mm / ø 2,0 mm		

mit Saugunterbrecher und Mandrin,
LUER-Bohrung
with finger cut-off and stylet, LUER hub



1/2
HOUSE
07-06-913
90 mm
3½"

Artikel-Nr. Cat. No.	Gesamtlänge Total length		
07-06-768	55 mm / 2¼" Saugadapter mit Saugunterbrecher Schlaucholive ø 7,0 mm suction adapter with finger cut-off olive ø 7,0 mm	HOUSE	



1/1
HOUSE
07-06-768
55 mm
2¼"



 1/2
VERHOEVEN
07-06-763
 100 mm
 4"

		Artikel-Nr. Cat. No.	Gesamtlänge Total length
	VERHOEVEN	07-06-763	100 mm / 4" ø 1,6 mm / 16 swg
		07-06-764	100 mm / 4" ø 1,2 mm / 18 swg
		07-06-765	100 mm / 4" ø 0,9 mm / 20 swg
		07-06-766	100 mm / 4" ø 0,7 mm / 22 swg
		07-06-767	100 mm / 4" ø 0,6 mm / 24 swg

 1/2
WULLSTEIN
15-07-960

		Artikel-Nr. Cat. No.	
	WULLSTEIN	15-07-960	Mikro-Absaugrohr, komplett, bestehend aus: Micro Suction Tube, complete, consisting of:
		15-07-961	1x Absaugrohr mit LUER-Bohrung suction tube with LUER hub
		15-07-962	1x Mikro-Saugkanüle ø 0,4 mm micro suction cannula ø 0.4 mm
		15-07-963	1x Mikro-Saugkanüle ø 0,6 mm micro suction cannula ø 0.6 mm
		15-07-964	1x Mikro-Saugkanüle ø 0,8 mm micro suction cannula ø 0.8 mm

Artikel-Nr.
Cat. No.

15-07-970	Absaugrohr, komplett, bestehend aus: Suction Tube, complete, consisting of:		
15-07-971	1 x Saughandgriff suction handle		
15-07-972	2 x Aufsatz ø 0,5 mm tip ø 0.5 mm		
15-07-973	2 x Aufsatz ø 0,7 mm tip ø 0.7 mm		
15-07-974	2 x Aufsatz ø 1,0 mm tip ø 1.0 mm		
15-07-975	2 x Aufsatz ø 1,3 mm tip ø 1.3 mm		



1/1
15-07-971

Artikel-Nr.
Cat. No.

15-07-971	Saughandgriff suction handle		
------------------	---	--	--

Artikel-Nr.
Cat. No.

15-07-972	Aufsatz ø 0,5 mm tip ø 0.5 mm		
15-07-973	Aufsatz ø 0,7 mm tip ø 0.7 mm		
15-07-974	Aufsatz ø 1,0 mm tip ø 1.0 mm		
15-07-975	Aufsatz ø 1,3 mm tip ø 1.3 mm		



1/1
15-07-972





1/2
ADSON
07-06-918
 165 mm
 6½"

		Artikel-Nr. Cat. No.	Gesamtlänge Total length
	ADSON	07-06-918	165 mm / 6½" ø 3 mm mit Saugunterbrecher und Mandrin <i>with finger cut-off and stylet</i>



1/2
BARRON
07-06-935
 160 mm
 6¼"

		Artikel-Nr. Cat. No.	Gesamtlänge Total length
	BARRON	07-06-935	160 mm / 6¼" ø 1,3 mm
		07-06-936	160 mm / 6¼" ø 2 mm
			mit Saugunterbrecher und Mandrin <i>with finger cut-off and stylet</i>



1/2
SCHUHKNECHT
07-06-756
 130 mm
 5⅛"

		Artikel-Nr. Cat. No.	Gesamtlänge Total length
	SCHUHKNECHT	07-06-756	130 mm / 5⅛" ø 0,9 mm
		07-06-757	130 mm / 5⅛" ø 0,5 mm

Artikel-Nr.
Cat. No.

15-07-950	Sauger, komplett, bestehend aus: suction set, complete, consisting of:	BELLUCCI	
15-07-951	1 x Saugkanüle suction tube		
07-56-772	1 x Saugspitze ø 0,9 mm suction tip ø 0.9 mm		
07-56-773	1 x Saugspitze ø 0,7 mm suction tip ø 0.7 mm		
07-56-774	1 x Saugspitze ø 0,5 mm suction tip ø 0.5 mm		



Artikel-Nr.
Cat. No.

Gesamtlänge
Total length

15-07-951	155 mm / 6"	BELLUCCI	
	Saugkanüle allein, mit Saugunterbrecher und Mandrin suction tube only, with finger cut-off and stylet		

Artikel-Nr.
Cat. No.

07-56-772	ø 0,9 mm	BELLUCCI	
	Saugspitze, auswechselbar suction tip, detachable		
07-56-773	ø 0,7 mm		
	Saugspitze, auswechselbar suction tip, detachable		
07-56-774	ø 0,5 mm		
	Saugspitze, auswechselbar suction tip, detachable		

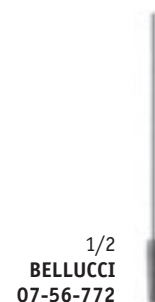

Artikel-Nr.
Cat. No.

Gesamtlänge
Total length

07-06-770	180 mm / 7" ø 2,5 mm	ZOELLNER	
	Saugkanüle allein, mit Mandrin, passend zu den Saugspitzen 07-06-771 bis 07-06-775 suction cannula only, with stylet, fitting to the suction tips 07-06-771 to 7-06-775		

Artikel-Nr.
Cat. No.

07-06-771	ø 1,2 mm	ZOELLNER	
07-06-772	ø 0,9 mm		
07-06-773	ø 0,7 mm		
07-06-774	ø 0,5 mm		
07-06-775	ø 0,4 mm		
	Saugspitzen, auswechselbar zu 07-06-770 und 15-07-951, Packung à 10 Stück suction tips, detachable, fitting to 07-06-770 and 15-07-951, package of 10 pcs.		





1/2
HARVEY
12-74-156
 160 mm
 6 1/4"



1/1

HARVEY**TC**
Artikel-Nr.
Cat. No.
12-74-156
Gesamtlänge
Total length

160 mm / 6 1/4"

 für weiche Drähte bis \varnothing 1,2 mm
 for soft wires up to \varnothing 1.2 mm

 für harte Drähte bis \varnothing 1,6 mm
 for hard wires up to \varnothing 1.6 mm

1/2
HARVEY
12-24-157
 235 mm
 9 1/4"



TC
Artikel-Nr.
Cat. No.
12-24-157
Gesamtlänge
Total length

235 mm / 9 1/4"

 für weiche Drähte bis \varnothing 3,0 mm
 for soft wires up to \varnothing 3.0 mm

 für harte Drähte bis \varnothing 2,2 mm
 for hard wires up to \varnothing 2.2 mm
HARVEY

TC

Artikel-Nr. Cat. No.	Gesamtlänge Total length	REIL	
12-24-159	180 mm / 7" für weiche Drähte bis \varnothing 2,0 mm for soft wires up to \varnothing 2.0 mm für harte Drähte bis \varnothing 1,7 mm for hard wires up to \varnothing 1.7 mm		1/1 
12-74-160	220 mm / 8¾" für weiche Drähte bis \varnothing 3,0 mm for soft wires up to \varnothing 3.0 mm für harte Drähte bis \varnothing 2,5 mm for hard wires up to \varnothing 2.5 mm		1/1 



1/2
12-74-160
220 mm
8¾"

TC

Artikel-Nr. Cat. No.	Gesamtlänge Total length		
12-24-158	180 mm / 7" Kopf- und Seitenschneider, für weichen Draht bis \varnothing 2,0 mm und harten Draht bis \varnothing 1,7 mm front and lateral cutting action, for soft wire up to \varnothing 2.0 mm and for hard wire up to \varnothing 1.7 mm		1/1 



1/2
12-24-158
180 mm
7"





1/2
HARVEY
02-03-815
 125 mm
 5"

		Artikel-Nr. Cat. No.	Gesamtlänge Total length
1/1	HARVEY	02-03-815	125 mm / 5"



1/2
04-16-551
 120 mm
 4¾"

		Artikel-Nr. Cat. No.	TC Artikel-Nr. Cat. No.	Gesamtlänge Total length
1/1		04-16-551	04-16-552	120 mm / 4¾" Eine Schneide gezahnt <i>one toothed cutting edge</i> für weiche Drähte bis ø 0,8 mm <i>for soft wires up to ø 0.8 mm</i> für harte Drähte bis ø 0,3 mm <i>for hard wires up to ø 0.3 mm</i>



1/2
04-16-530
 140 mm
 5½"

		TC Artikel-Nr. Cat. No.	Gesamtlänge Total length
		04-16-530	140 mm / 5½" für weiche Drähte bis ø 1,4 mm <i>for soft wires up to ø 1.4 mm</i> für harte Drähte bis ø 1,0 mm <i>for hard wires up to ø 1.0 mm</i>

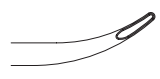
Artikel-Nr. Cat. No.	Gesamtlänge Total length		
06-15-599	130 mm / 5 1/8"		1/1 

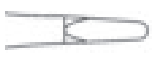

1/2
06-15-599
130 mm
5 1/8"

Artikel-Nr. Cat. No.	Gesamtlänge Total length		
13-04-617	155 mm / 6"	LEMPERT	1/1 



1/2
LEMPERT
13-04-617
155 mm
6"





1/2
FRIEDMANN
06-15-406
 140 mm
 5½"



		Artikel-Nr. Cat. No.	Gesamtlänge Total length
1/1	FRIEDMANN	06-15-406	140 mm / 5½"



1/2
FRIEDMANN
06-15-407
 140 mm
 5½"



		Artikel-Nr. Cat. No.	Gesamtlänge Total length
1/1	FRIEDMANN	06-15-407	140 mm / 5½"



Artikel-Nr. Cat. No.	Gesamtlänge Total length		
06-65-397	140 mm / 5½"	KLEINERT-KUTZ	1/1 
06-65-398	140 mm / 5½"	KLEINERT-KUTZ	1/1 



1/2
KLEINERT-KUTZ
06-65-397
140 mm
5½"

Artikel-Nr. Cat. No.	Gesamtlänge Total length		
06-15-409	145 mm / 5¾"	LUER-FRIEDMANN	1/1 
06-15-408	145 mm / 5¾"		1/1 



1/2
LUER-FRIEDMANN
06-15-409
145 mm
5¾"





1/2
LUER
06-15-412
150 mm
6"



		Artikel-Nr. Cat. No.	Gesamtlänge Total length
1/1		06-15-410	140 mm / 5½"
1/1	LUER 	06-15-411	150 mm / 6"
1/1	LUER 	06-15-412	150 mm / 6"
1/1	BLUMEN- THAL 	06-15-415	150 mm / 6"
1/1	BLUMEN- THAL 	06-15-416	150 mm / 6"



1/2
06-15-413
150 mm
6"



		Artikel-Nr. Cat. No.	Gesamtlänge Total length
1/1		06-15-413	150 mm / 6"
1/1		06-15-414	145 mm / 5¾"



Artikel-Nr. Cat. No.	Gesamtlänge Total length		
06-15-399	175 mm / 7"	STELLBRINK	1/1 
06-15-400	170 mm / 6¾"	STELLBRINK	1/1 

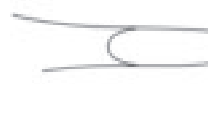

1/2
STELLBRINK
06-15-399
175 mm
7"

Artikel-Nr. Cat. No.	Gesamtlänge Total length		
06-15-457	175 mm / 7"	BANE- HARTMANN	1/1 
06-15-430	175 mm / 7"	JANSEN	1/1 
06-15-432	175 mm / 7"	JANSEN	1/1 



1/2
JANSEN
06-15-430
175 mm
7"





1/2
BEYER
06-15-453
 180 mm
 7"

		Artikel-Nr. Cat. No.	Gesamtlänge Total length
1/1	BEYER	06-15-453	180 mm / 7"
1/1	BEYER	06-65-453	180 mm / 7"



1/2
MEAD
06-15-455
 165 mm
 6½"

		Artikel-Nr. Cat. No.	Gesamtlänge Total length
1/1	MEAD	06-15-455	165 mm / 6½"
1/1	MEAD	06-15-459	165 mm / 6½"



Artikel-Nr. Cat. No.	Gesamtlänge Total length		
06-15-442	190 mm / 7½"	JANSEN	1/1



1/2
JANSEN
06-15-442
190 mm
7½"

Artikel-Nr. Cat. No.	Gesamtlänge Total length		
06-15-450	200 mm / 8"	LEMPERT	1/1
06-15-451	200 mm / 8"	LEMPERT	1/1



1/2
LEMPERT
06-15-450
200 mm
8"





1/2
LUER
06-15-460
 170 mm
 6¾"

		Artikel-Nr. Cat. No.	Gesamtlänge Total length
1/1	LUER	06-15-460	170 mm / 6¾"
1/1	LUER	06-15-461	170 mm / 6¾"
1/1	LUER	06-15-462	180 mm / 7"
1/1	LUER	06-15-463	180 mm / 7"



1/2
GULEKE
06-15-472
 205 mm
 8"

		Artikel-Nr. Cat. No.	Gesamtlänge Total length
1/1	OLIVE-CRONA	06-15-470	200 mm / 8"
1/1	GULEKE	06-15-472	205 mm / 8"
1/1	PENNY-BACKER	06-15-475	200 mm / 8"

Artikel-Nr. Cat. No.	Gesamtlänge Total length		
06-15-474	210 mm / 8¼"	NORTH-FIELD	1/1 



1/2
NORTHFIELD
06-15-474
210 mm
8¼"

Artikel-Nr. Cat. No.	Gesamtlänge Total length		
13-04-615	200 mm / 8"	ADSON	1/1 

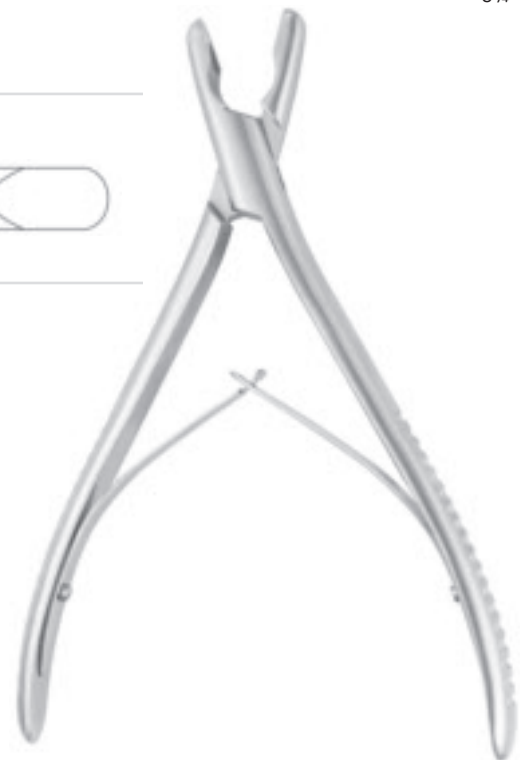

1/2
ADSON
13-04-615
200 mm
8"







		Artikel-Nr. Cat. No.	Gesamtlänge Total length
1/1	HAKANSON	06-15-428	170 mm / 6¾" seitwärts gebogen curved to side
1/1	TROTTER	06-15-467	205 mm / 8" seitwärts gebogen curved to side





		Artikel-Nr. Cat. No.	Gesamtlänge Total length
1/1 3 mm	LEKSELL	06-65-560	360 mm / 14½"
1/1 5 mm	LEKSELL	06-65-561	360 mm / 14½"
1/1 8 mm	LEKSELL	06-65-562	360 mm / 14½"

Artikel-Nr. Cat. No.	Gesamtlänge Total length		
06-15-500	155 mm / 6"	BÖHLER	1/1 2 mm 
06-15-502	155 mm / 6"	BÖHLER	1/1 3 mm 



1/2
BÖHLER
06-15-500
155 mm
6"

Artikel-Nr. Cat. No.	Gesamtlänge Total length		
06-15-511	175 mm / 7"	MAYFIELD	1/1 3 mm 
06-15-520	200 mm / 8"	MAR- QUARDT	1/1 3 mm 



1/2
MAYFIELD
06-15-511
175 mm
7"





1/2
BEYER
06-15-514
 180 mm
 7"



		Artikel-Nr. Cat. No.	Gesamtlänge Total length
1/1 3 mm	BEYER	06-15-514	180 mm / 7"
1/1 5 mm	ZAUFAL- JANSEN	06-15-515	180 mm / 7"



1/2
RUSKIN
06-15-518
 190 mm
 7½"

		Artikel-Nr. Cat. No.	Gesamtlänge Total length
1/1 5 mm	RÖTTGEN- RUSKIN	06-65-516 06-65-517	190 mm / 7½" 240 mm / 9½"
1/1 5 mm	RUSKIN	06-15-518 06-15-521	190 mm / 7½" 240 mm / 9½"



Artikel-Nr. Cat. No.	Gesamtlänge Total length		
06-15-522	230 mm / 9"	ECHLIN	1/1 2 mm 
06-15-523	230 mm / 9"	ECHLIN	1/1 3 mm 
06-65-524	230 mm / 9"	ECHLIN	1/1 4 mm 





Artikel-Nr. Cat. No.	Gesamtlänge Total length		
06-15-525	240 mm / 9½"	FRYKHOLM	1/1 5 mm 





		Artikel-Nr. Cat. No.	Gesamtlänge Total length
	1/1 6 mm STILLE	06-15-530	235 mm / 9¼"

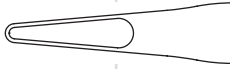



		Artikel-Nr. Cat. No.	Gesamtlänge Total length
	1/1 3 mm LEKSELL	06-15-527	240 mm / 9½"
	1/1 5 mm LEKSELL	06-15-526	240 mm / 9½"
	1/1 8 mm LEKSELL-STILLE	06-15-532	240 mm / 9½"

Artikel-Nr. Cat. No.	Gesamtlänge Total length		
06-15-534	240 mm / 9½"	STILLE- RUSKIN	1/1 8 mm 



1/3
STILLE-RUSKIN
06-15-534
240 mm
9½"



Artikel-Nr. Cat. No.	Gesamtlänge Total length		
06-65-535	230 mm / 9"	LEKSELL	1/1 3 mm 
06-65-536	230 mm / 9"	LEKSELL	1/1 6 mm 
06-65-537	230 mm / 9"	LEKSELL	1/1 8 mm 



1/3
LEKSELL
06-65-536
230 mm
9"







1/3
LUER-STILLE
06-15-551
 225 mm
 9"

		Artikel-Nr. Cat. No.	Gesamtlänge Total length
 1/1 10 mm LUER-STILLE		06-15-550	225 mm / 9"
		06-65-551	270 mm / 10 $\frac{3}{4}$ "
 1/1 10 mm LUER-STILLE		06-15-551	225 mm / 9"
		06-65-552	270 mm / 10 $\frac{3}{4}$ "

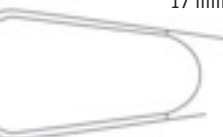



1/3
LUER-STILLE
06-15-566
 270 mm
 10 $\frac{3}{4}$ "

		Artikel-Nr. Cat. No.	Gesamtlänge Total length
 1/1 17 mm LUER-STILLE		06-65-553	230 mm / 9"
		06-65-554	270 mm / 10 $\frac{3}{4}$ "
 1/1 17 mm LUER-STILLE		06-65-556	230 mm / 9"
		06-15-566	270 mm / 10 $\frac{3}{4}$ "
 1/1 SEMB		06-15-555	230 mm / 9"
		06-65-557	270 mm / 10 $\frac{3}{4}$ "

Artikel-Nr. Cat. No.	Gesamtlänge Total length		
06-15-601	130 mm / 5 $\frac{1}{8}$ "		1/1 
06-15-602	170 mm / 6 $\frac{3}{4}$ "		1/1 



1/2
06-15-602
170 mm
6 $\frac{3}{4}$ "

Artikel-Nr. Cat. No.	Gesamtlänge Total length		
06-15-610	145 mm / 5 $\frac{3}{4}$ "	BÖHLER	1/1 
06-15-611	145 mm / 5 $\frac{3}{4}$ "	BÖHLER	1/1 



1/2
BÖHLER
06-15-610
145 mm
5 $\frac{3}{4}$ "





 1/2
LISTON
06-15-622
 170 mm
 6¾"

		Artikel-Nr. Cat. No.	Gesamtlänge Total length
1/1	LISTON	06-15-620	140 mm / 5½"
1/1	LISTON	06-15-622	170 mm / 6¾"
1/1	LISTON	06-15-624	200 mm / 8"
1/1	LISTON	06-15-626	220 mm / 8¾"



 1/2
LISTON
06-15-632
 170 mm
 6¾"

		Artikel-Nr. Cat. No.	Gesamtlänge Total length
1/1	LISTON	06-65-531	140 mm / 5½"
1/1	LISTON	06-15-632	170 mm / 6¾"
1/1	LISTON	06-15-634	200 mm / 8"
1/1	LISTON	06-15-636	220 mm / 8¾"

Artikel-Nr. Cat. No.	Gesamtlänge Total length		
06-15-614	175 mm / 7"	MC INDOE	1/1 



1/2
MC INDOE
06-15-614
175 mm
7"

Artikel-Nr. Cat. No.	Gesamtlänge Total length		
06-15-640	190 mm / 7½"	RUSKIN-LISTON	1/1 
06-15-641	190 mm / 7½"	RUSKIN-LISTON	1/1 



1/2
RUSKIN-LISTON
06-15-640
190 mm
7½"







1/2
LISTON
06-15-646
 280 mm
 11"

		Artikel-Nr. Cat. No.	Gesamtlänge Total length
	1/1	LISTON 06-15-645	240 mm / 9½"
		06-65-645	270 mm / 10¾"



		Artikel-Nr. Cat. No.	Gesamtlänge Total length
	1/1	LISTON 06-15-646	280 mm / 11"



Artikel-Nr. Cat. No.	Gesamtlänge Total length		
06-11-120	165 mm / 6½"	WILLIGER	1/1 5 mm
	Elevatorium elevator		
06-11-121	170 mm / 6¾"	WILLIGER	1/1 5,5 mm
	Elevatorium elevator		



1/2
WILLIGER
06-11-121
170 mm
6¾"

Artikel-Nr. Cat. No.	Gesamtlänge Total length		
15-13-307	155 mm / 6"	KÖNIG	1/1 4,5 mm
	Elevatorium elevator		
15-13-308	155 mm / 6"	KÖNIG	1/1 4,5 mm
	Elevatorium elevator		
06-11-110	155 mm / 6"		1/1 5,5 mm
	Knochenheber bone lever		



1/2
KÖNIG
15-13-308
155 mm
6"





1/2
MC DONALD
06-11-291
190 mm
7½"

		Artikel-Nr. Cat. No.	Gesamtlänge Total length
1/1	MC DONALD	06-11-291	190 mm / 7½"



1/2
WATSON-CHEYNE
06-11-292
125 mm
5"

		Artikel-Nr. Cat. No.	Gesamtlänge Total length
1/1	WATSON-CHEYNE	06-11-292	125 mm / 5"
1/1	WATSON-CHEYNE	06-11-293	190 mm / 7½"



1/2
FREER
15-12-164
180 mm
7"

		Artikel-Nr. Cat. No.	Gesamtlänge Total length
1/1	FREER	15-12-164	180 mm / 7"

Artikel-Nr. Cat. No.	Gesamtlänge Total length		
15-13-314	140 mm / 5½"		1/1 4 mm
	links gebogen <i>curved left</i>		
15-13-315	140 mm / 5½"		1/1 4 mm
	rechts gebogen <i>curved right</i>		



1/2
15-13-314
140 mm
5½"

Artikel-Nr. Cat. No.	Gesamtlänge Total length		
04-15-543	180 mm / 7"	MOLT	1/1
			



1/2
MOLT
04-15-543
180 mm
7"





		Artikel-Nr. Cat. No.	Gesamtlänge Total length
1/1 6,3 mm	LEMPERT	15-07-164	185 mm / 7¼"
			halbscharf semi-sharp

 1/2
LEMPERT
15-07-164
 185 mm
 7¼"

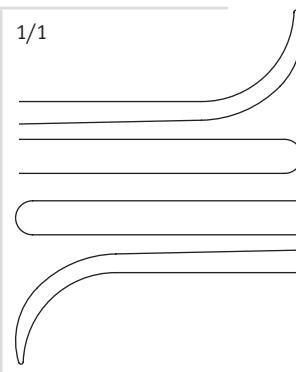

		Artikel-Nr. Cat. No.	Gesamtlänge Total length
1/1 3,2 mm	LEMPERT	15-07-165	165 mm / 6½"
			stumpf blunt

 1/2
LEMPERT
15-07-165
 165 mm
 6½"

Artikel-Nr. Cat. No.	Gesamtlänge Total length		
15-12-155	230 mm / 9"	COTTLE	1/1
	scharf / scharf sharp / sharp		

1/2
COTTLE
15-12-155
230 mm
9"

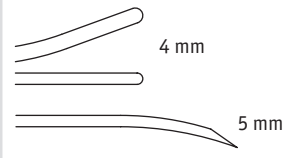

Artikel-Nr. Cat. No.	Gesamtlänge Total length		
15-12-179	220 mm / 8¾"	HILL	1/1
	stumpf / halbscharf blunt / semi-sharp		

1/2
HILL
15-12-179
220 mm
8¾"



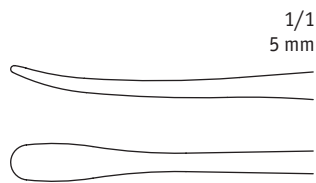

1/2
LANGENBECK
06-11-130
 195 mm
 7¾"

**SEBILEAU**
Artikel-Nr.
Cat. No.
06-11-124
Gesamtlänge
Total length

175 mm / 7"

**QUERVAIN****06-11-133**

195 mm / 7¾"

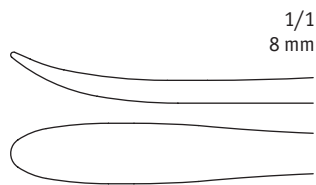
**LANGEN-
BECK****06-11-130**

195 mm / 7¾"

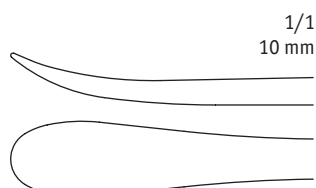
**LANGEN-
BECK****06-11-131**

195 mm / 7¾"

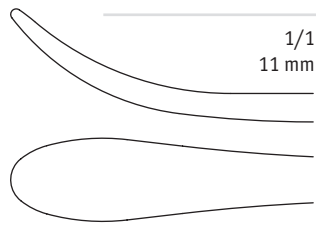

1/2
LANGENBECK
06-11-139
 230 mm
 9"

**LANGEN-
BECK**
Artikel-Nr.
Cat. No.
06-11-139
Gesamtlänge
Total length

230 mm / 9"

Artikel-Nr. Cat. No.	Gesamtlänge Total length		
04-15-510	140 mm / 5½"	WILLIGER	1/1 4,2 mm 
06-11-300	160 mm / 6¼"	WILLIGER	1/1 6 mm 
06-11-303	160 mm / 6¼"	WILLIGER	1/1 8 mm 

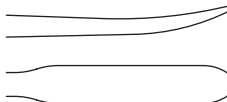

1/2
WILLIGER
04-15-510
140 mm
5½"

Artikel-Nr. Cat. No.	Gesamtlänge Total length		
15-13-309	155 mm / 6"	KÖNIG	1/1 5 mm 



1/2
KÖNIG
15-13-309
155 mm
6"





1/2
SEDILLOT
06-11-350
 185 mm
 7¼"

	Artikel-Nr. Cat. No.	Gesamtlänge Total length
<p>1/1 18 mm</p> <p>SEDILLOT</p>	06-11-350	185 mm / 7¼"



1/2
MITCHELL
06-11-336
 210 mm
 8¼"

	Artikel-Nr. Cat. No.	Gesamtlänge Total length
<p>1/1 17 mm</p> <p>MITCHELL</p>	06-11-336	210 mm / 8¼"

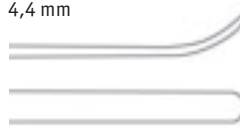

Artikel-Nr. Cat. No.	Gesamtlänge Total length		
15-12-192	155 mm / 6"	MC KENTY	1/1 4,4 mm 



1/2
MC KENTY
15-12-192
155 mm
6"

Artikel-Nr. Cat. No.	Gesamtlänge Total length		
15-12-198	200 mm / 8" stumpf blunt	SEWALL	1/1 6 mm 



1/2
SEWALL
15-12-198
200 mm
8"





1/2
HOWARTH
15-12-171
215 mm
8½"

		Artikel-Nr. Cat. No.	Gesamtlänge Total length
1/1	HOWARTH	15-12-171	215 mm / 8½" scharf / stumpf sharp / blunt





1/2
KILLIAN
15-12-172
185 mm
7¼"

		Artikel-Nr. Cat. No.	Gesamtlänge Total length
1/1	KILLIAN	15-12-170	185 mm / 7¼" scharf / stumpf sharp / blunt

		Artikel-Nr. Cat. No.	Gesamtlänge Total length
1/1	KILLIAN	15-12-172	185 mm / 7¼" scharf / stumpf sharp / blunt



Artikel-Nr. Cat. No.	Gesamtlänge Total length	KEY	
06-61-410	180 mm / 7"	KEY	1/1 3 mm 
06-11-410	180 mm / 7"	KEY	1/1 6 mm 
06-11-411	190 mm / 7½"	KEY	1/1 10 mm 
06-11-412	190 mm / 7½"	KEY	1/1 13 mm 
06-61-412	190 mm / 7½"	KEY	1/1 16 mm 
06-11-413	200 mm / 8"	KEY	1/1 19 mm 
06-11-414	210 mm / 8¼"	KEY	1/1 25 mm 



1/1
KEY
06-11-410
180 mm
7"





1/1
MANNERFELT
06-11-532
155 mm
6"

		Artikel-Nr. Cat. No.	Gesamtlänge Total length
1/1 4 mm	MANNER- FELT	06-11-530	155 mm / 6"
1/1 7 mm	MANNER- FELT	06-11-532	155 mm / 6"
1/1 9 mm	MANNER- FELT	06-11-534	155 mm / 6"

		Artikel-Nr. Cat. No.	Gesamtlänge Total length
1/1 3 mm	MANNER- FELT	06-11-541	155 mm / 6"
1/1 6 mm	MANNER- FELT	06-11-542	155 mm / 6"
1/1 6 mm	MANNER- FELT	06-11-543	155 mm / 6"

		Artikel-Nr. Cat. No.	Gesamtlänge Total length
1/1 6 mm	MANNER- FELT	06-11-551	155 mm / 6"
1/1 8 mm	MANNER- FELT	06-11-552	155 mm / 6"



Artikel-Nr. Cat. No.	Gesamtlänge Total length	MANNER- FELT	1/1 4 mm
06-11-556	155 mm / 6"	MANNER- FELT	1/1 4 mm
06-11-554	155 mm / 6"	MANNER- FELT	1/1 5 mm
06-11-553	155 mm / 6"	MANNER- FELT	1/1 6 mm

Artikel-Nr. Cat. No.	Gesamtlänge Total length	MANNER- FELT	1/1 4 mm
06-11-560	155 mm / 6"	MANNER- FELT	1/1 4 mm
06-11-562	155 mm / 6"	MANNER- FELT	1/1 6 mm
06-11-565	155 mm / 6"	MANNER- FELT	1/1 3,5 mm



1/1
MANNERFELT
06-11-554
155 mm
6"





		Artikel-Nr. Cat. No.	Gesamtlänge Total length
1/1 6 mm		06-11-301	165 mm / 6½"
1/1 8 mm		06-11-302	165 mm / 6½"

1/2
06-11-301
 165 mm
 6½"



		Artikel-Nr. Cat. No.	Gesamtlänge Total length
1/1 8 mm		ADSON 06-11-306	170 mm / 6¾"
1/1 7 mm		ADSON 06-11-307	170 mm / 6¾"
1/1 7 mm		ADSON 06-11-308	170 mm / 6¾"
1/1 7 mm		ADSON 06-11-309	170 mm / 6¾"

1/2
ADSON
06-11-306
 170 mm
 6¾"

Artikel-Nr. Cat. No.	Gesamtlänge Total length		
06-11-310	180 mm / 7"	JOSEPH	1/1 4 mm 

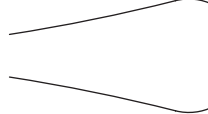
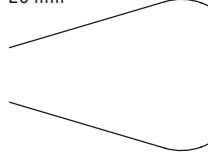

1/2
JOSEPH
06-11-310
180 mm
7"

Artikel-Nr. Cat. No.	Gesamtlänge Total length		
06-61-311	160 mm / 7½"	HOEN	1/1 7 mm 
06-61-312	190 mm / 7½"	HOEN	1/1 15 mm 
06-61-313	190 mm / 7½"	HOEN	1/1 20 mm 



1/2
HOEN
06-61-312
190 mm
7½"





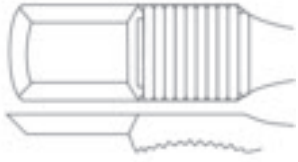
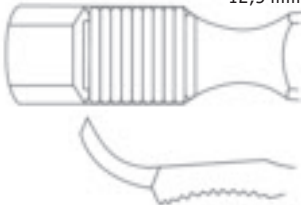



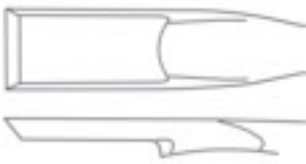

		Artikel-Nr. Cat. No.	Gesamtlänge Total length
1/1 12,5 mm		FARABEUF 06-11-340	140 mm / 5½"
1/1 12,5 mm		FARABEUF 06-11-341	140 mm / 5½"

1/2
FARABEUF
06-11-340
 140 mm
 5½"



		Artikel-Nr. Cat. No.	Gesamtlänge Total length
1/1 11 mm		FARABEUF-COLLIN 06-11-344	160 mm / 6¼"
1/1 11 mm		FARABEUF-COLLIN 06-11-345	160 mm / 6¼"

1/2
FARABEUF-COLLIN
06-11-344
 160 mm
 6¼"

Artikel-Nr. Cat. No.	Gesamtlänge Total length		
06-11-355	215 mm / 8½"	LAMBOTTE	1/1 5 mm 
06-11-356	215 mm / 8½"	LAMBOTTE	1/1 10 mm 
06-11-357	215 mm / 8½"	LAMBOTTE	1/1 15 mm 
06-11-358	215 mm / 8½"	LAMBOTTE	1/1 20 mm 
06-11-359	215 mm / 8½"	LAMBOTTE	1/1 25 mm 



1/2
LAMBOTTE
06-11-357
215 mm
8½"



1/2
JANSEN
06-11-362
165 mm
6½"

Artikel-Nr. Cat. No.	Gesamtlänge Total length		
06-11-362	165 mm / 6½"	JANSEN	1/1 15 mm 





1/2
SCHNEIDER
06-11-365
 175 mm
 7"

		Artikel-Nr. Cat. No.	Gesamtlänge Total length
<p>1/1 13 mm</p>	SCHNEIDER	06-11-365	175 mm / 7"
<p>1/1 14 mm</p>	SCHNEIDER- SAUER- BRUCH	06-11-366	190 mm / 7½"



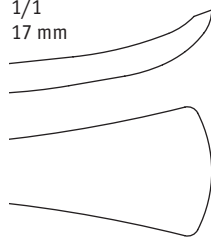
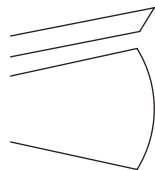
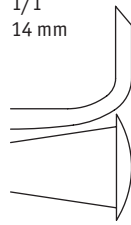
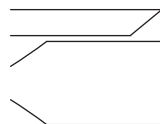

1/2
SEDILLOT
06-11-351
 215 mm
 8½"

		Artikel-Nr. Cat. No.	Gesamtlänge Total length
<p>1/1 15 mm</p>	SEDILLOT	06-11-351	215 mm / 8½"

Artikel-Nr. Cat. No.	Gesamtlänge Total length		
13-02-279	190 mm / 7½"	LANGEN- BECK	1/1 17 mm 
06-11-360	190 mm / 7½"	LANGEN- BECK	1/1 16 mm 
06-11-361	180 mm / 7"	LANGEN- BECK	1/1 14 mm 
06-11-379	195 mm / 7¾"	MC KISSOCK	1/1 11 mm 

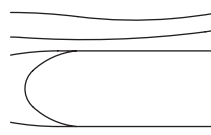

1/2
LANGENBECK
06-11-360
190 mm
7½"

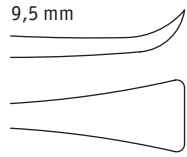
Artikel-Nr. Cat. No.	Gesamtlänge Total length		
06-11-390	185 mm / 7¼"	KRÄMER	1/1 10 mm 
06-11-391	190 mm / 7½"	KRÄMER	1/1 10 mm 
04-15-518	190 mm / 7½"	BÜCHS	1/1 9,5 mm 





1/2
KRÄMER
06-11-390
185 mm
7¼"





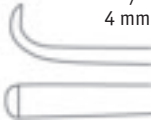

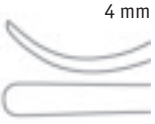
1/2
MÜHLING
06-11-394
 170 mm
 6¾"





		Artikel-Nr. Cat. No.	Gesamtlänge Total length
	1/1 4 mm	MÜHLING 06-11-394	170 mm / 6¾"
	1/1 4 mm	MÜHLING 06-11-395	170 mm / 6¾"
	1/1 4 mm	MÜHLING 06-11-396	170 mm / 6¾"
	1/1 4 mm	MÜHLING 06-11-397	170 mm / 6¾"

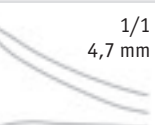
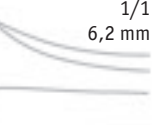
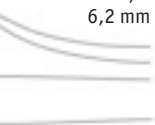
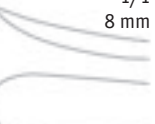

1/2
LANDOLT
06-11-314
 175 mm
 7"

		Artikel-Nr. Cat. No.	Gesamtlänge Total length
	1/1 3 mm	04-15-521	170 mm / 6¾"
	1/1 6 mm	04-15-523	170 mm / 6¾"
	1/1 4,7 mm	LANDOLT 06-11-314	175 mm / 7"
	1/1 6,2 mm	CASPAR 06-11-328	180 mm / 7"
	1/1 6,2 mm	CASPAR 06-11-329	180 mm / 7"
	1/1 8 mm	COTTLE 15-12-157	195 mm / 7¾"



Artikel-Nr. Cat. No.	Gesamtlänge Total length		
06-11-317	185 mm / 7¼"	mit Ferrozell-Griff with handle from artificial wood	1/1 3 mm 
06-11-318	190 mm / 7½"	mit Ferrozell-Griff with handle from artificial wood	1/1 6 mm 
06-11-319	190 mm / 7½"	mit Ferrozell-Griff with handle from artificial wood	1/1 6 mm 
06-11-321	190 mm / 7½"	mit Ferrozell-Griff with handle from artificial wood	1/1 6 mm 



1/2
06-11-318
190 mm
7½"

 1/2
06-11-324
 195 mm
 7¾"

	Artikel-Nr. Cat. No.	Gesamtlänge Total length
<p>1/1 13 mm</p>	06-11-323	185 mm / 7¼" mit Ferrozell-Griff <i>with handle from artificial wood</i>
<p>1/1 14 mm</p>	06-11-324	195 mm / 7¾" mit Ferrozell-Griff <i>with handle from artificial wood</i>
<p>1/1 14 mm</p>	06-11-325	190 mm / 7½" mit Ferrozell-Griff <i>with handle from artificial wood</i>



 1/2
06-61-327
 205 mm
 8"

	Artikel-Nr. Cat. No.	Gesamtlänge Total length
<p>1/1 20 mm</p>	06-61-327	205 mm / 8" mit Ferrozell-Griff <i>with handle from artificial wood</i>

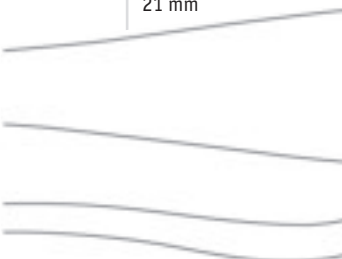

Artikel-Nr. Cat. No.	Gesamtlänge Total length		
06-61-328	330 mm / 13"	WAGNER	1/1 8 mm
mit Ferrozell-Griff with handle from artificial wood			

Artikel-Nr. Cat. No.	Gesamtlänge Total length		
06-61-329	330 mm / 13"	WAGNER	1/1 17 mm
mit Ferrozell-Griff with handle from artificial wood			

Artikel-Nr. Cat. No.	Gesamtlänge Total length		
06-61-330	275 mm / 10¾"	WAGNER	1/1 21 mm
mit Ferrozell-Griff with handle from artificial wood			



1/2
WAGNER
06-61-328
330 mm
13"











1/2
COBB
06-11-146
280 mm
11"

		Artikel-Nr. Cat. No.	Gesamtlänge Total length
1/1 10 mm	COBB	06-11-146	280 mm / 11"
1/1 13 mm	COBB	06-11-147	280 mm / 11"
1/1 19 mm	COBB	06-11-148	280 mm / 11"
1/1 25 mm	COBB	06-11-149	280 mm / 11"
1/1 32 mm	COBB	06-11-157	280 mm / 11"



		Artikel-Nr. Cat. No.	Gesamtlänge Total length
1/1 4 mm		06-61-331	280 mm / 11"
1/1 6 mm		06-61-332	280 mm / 11"
1/1 8 mm		06-61-333	280 mm / 11"



Artikel-Nr. Cat. No.	Gesamtlänge Total length		
06-11-801	140 mm / 5½"	MARTINI	1/1 
06-11-814	145 mm / 5¾"	WILLIGER	1/1 
06-11-850	210 mm / 8¼"		1/1 
06-11-840	130 mm / 5½"	VOLKMANN	1/1 
06-11-841	145 mm / 5¾"	VOLKMANN	1/1 
06-11-842	170 mm / 6¾"	VOLKMANN	1/1 



1/2
WILLIGER
06-11-814
145 mm
5¾"











Artikel-Nr. Cat. No.	Gesamtlänge Total length		
06-11-845	130 mm / 5½"		1/1 
06-11-846	160 mm / 6¼"		1/1 
06-11-848	200 mm / 8"		1/1 







1/2
06-11-846
160 mm
6¼"









 1/1
VOLKMANN
06-11-632
 170 mm
 6¾"

		Artikel-Nr. Cat. No.	Gesamtlänge Total length
1/1 2,8 mm 	VOLKMANN	06-11-630	170 mm / 6¾" Fig. 0000
1/1 3,6 mm 	VOLKMANN	06-11-631	170 mm / 6¾" Fig. 000
1/1 4,4 mm 	VOLKMANN	06-11-632	170 mm / 6¾" Fig. 00
1/1 5,2 mm 	VOLKMANN	06-11-633	170 mm / 6¾" Fig. 0
1/1 6,8 mm 	VOLKMANN	06-11-634	170 mm / 6¾" Fig. 1
1/1 8,5 mm 	VOLKMANN	06-11-635	170 mm / 6¾" Fig. 2
1/1 10 mm 	VOLKMANN	06-11-636	170 mm / 6¾" Fig. 3
1/1 11,5 mm 	VOLKMANN	06-11-637	170 mm / 6¾" Fig. 4
1/1 13 mm 	VOLKMANN	06-11-638	170 mm / 6¾" Fig. 5
1/1 14,5 mm 	VOLKMANN	06-11-639	170 mm / 6¾" Fig. 6

Artikel-Nr. Cat. No.	Gesamtlänge Total length		
06-11-662	200 mm / 8" Fig. 0000	DAUBEN-SPECK	1/1 2,8 mm 
06-11-663	200 mm / 8" Fig. 000	DAUBEN-SPECK	1/1 3,6 mm 
06-11-664	200 mm / 8" Fig. 00	DAUBEN-SPECK	1/1 4,4 mm 
06-11-665	200 mm / 8" Fig. 0	DAUBEN-SPECK	1/1 5,2 mm 



1/2
DAUBENSPECK
06-11-665
200 mm
8"

Artikel-Nr. Cat. No.	Gesamtlänge Total length		
06-11-675 06-61-675	215 mm / 8½" gerade / straight gewinkelt / angled	LEMPERT	1/1 1,8 mm 
06-11-676 06-61-676	215 mm / 8½" gerade / straight gewinkelt / angled	LEMPERT	1/1 2 mm 
06-11-677 06-61-677	215 mm / 8½" gerade / straight gewinkelt / angled	LEMPERT	1/1 2,4 mm 
06-11-678 06-61-678	215 mm / 8½" gerade / straight gewinkelt / angled	LEMPERT	1/1 2,6 mm 
06-11-679 06-61-679	215 mm / 8½" gerade / straight gewinkelt / angled	LEMPERT	1/1 2,8 mm 



1/1
LEMPERT
06-11-677
215 mm
8½"













1/2
HALLE
06-11-686
 215 mm
 8½"

		Artikel-Nr. Cat. No.	Gesamtlänge Total length
1/1 4,4 mm	HALLE	06-11-684	215 mm / 8½" Fig. 00 biegsam malleable
1/1 5,2 mm	HALLE	06-11-685	215 mm / 8½" Fig. 0 biegsam malleable
1/1 6,8 mm	HALLE	06-11-686	215 mm / 8½" Fig. 1 biegsam malleable



1/2
SIMON
06-11-689
 235 mm
 9¼"

		Artikel-Nr. Cat. No.	Gesamtlänge Total length
1/1 3,6 mm	SIMON	06-11-688	235 mm / 9¼" Fig. 000
1/1 4,4 mm	SIMON	06-11-689	235 mm / 9¼" Fig. 00
1/1 5,2 mm	SIMON	06-11-690	235 mm / 9¼" Fig. 0

Artikel-Nr. Cat. No.	Gesamtlänge Total length	BRUNS	
13-02-872	230 mm / 9" Fig. 000	BRUNS	1/1 2 mm 
13-02-873	230 mm / 9" Fig. 00	BRUNS	1/1 2,5 mm 
13-02-874	230 mm / 9" Fig. 0	BRUNS	1/1 3,3 mm 
13-02-875	230 mm / 9" Fig. 1	BRUNS	1/1 3,8 mm 
13-02-876	230 mm / 9" Fig. 2	BRUNS	1/1 4,8 mm 
13-02-877	230 mm / 9" Fig. 3	BRUNS	1/1 5,3 mm 
13-02-878	230 mm / 9" Fig. 4	BRUNS	1/1 6,0 mm 
13-02-879	230 mm / 9" Fig. 5	BRUNS	1/1 6,7 mm 
13-02-880	230 mm / 9" Fig. 6	BRUNS	1/1 7,3 mm 



1/2
BRUNS
13-02-876
230 mm
9"



 1/3
06-11-704
 250 mm
 10"

		Artikel-Nr. Cat. No.	Gesamtlänge Total length
1/1 3,6 mm		06-11-702	250 mm / 10" Fig. 000
		06-11-712	gerade / straight gewinkelt / angled
1/1 4,4 mm		06-11-703	250 mm / 10" Fig. 00
		06-11-713	gerade / straight gewinkelt / angled
1/1 5,2 mm		06-11-704	250 mm / 10" Fig. 0
		06-11-714	gerade / straight gewinkelt / angled
1/1 6,8 mm		06-11-705	250 mm / 10" Fig. 1
		06-11-715	gerade / straight gewinkelt / angled

 1/3
BUSHE
06-11-724
 250 mm
 10"

		Artikel-Nr. Cat. No.	Gesamtlänge Total length
1/1 3 mm	BUSHE 	06-11-723	250 mm / 10"
1/1 4 mm	BUSHE 	06-11-724	250 mm / 10"
1/1 5 mm	BUSHE 	06-11-725	250 mm / 10"



Artikel-Nr. Cat. No.	Gesamtlänge Total length		
	220 mm / 8¾"	CASPAR	1/1 3,6 mm
06-11-773	gerade / <i>straight</i>		
06-11-783	gewinkelt / <i>angled</i>		
	220 mm / 8¾"	CASPAR	1/1 4,4 mm
06-11-774	gerade / <i>straight</i>		
06-11-784	gewinkelt / <i>angled</i>		
	220 mm / 8¾"	CASPAR	1/1 5,2 mm
06-11-775	gerade / <i>straight</i>		
06-11-785	gewinkelt / <i>angled</i>		



1/2
CASPAR
06-11-775
220 mm
8¾"

Artikel-Nr. Cat. No.	Gesamtlänge Total length		
06-11-834	220 mm / 8¾"	CASPAR	1/1 4 mm
	gezahnt <i>toothed</i>		
06-11-835	220 mm / 8¾"	CASPAR	1/1 5 mm
	gezahnt <i>toothed</i>		
06-11-836	220 mm / 8¾"	CASPAR	1/1 6 mm
	gezahnt <i>toothed</i>		



1/2
CASPAR
06-11-835
220 mm
8¾"







1/2
CASPAR
06-11-854
 250 mm
 10"

		Artikel-Nr. Cat. No.	Gesamtlänge Total length
	1/1 4 mm	CASPAR 06-11-854	250 mm / 10" gezahnt toothed
	1/1 5 mm	CASPAR 06-11-855	250 mm / 10" gezahnt toothed





1/2
CASPAR
06-11-863
 270 mm
 10¾"

		Artikel-Nr. Cat. No.	Gesamtlänge Total length
	1/1 3 mm	CASPAR 06-11-863	270 mm / 10¾" gezahnt toothed
	1/1 4 mm	CASPAR 06-11-864	270 mm / 10¾" gezahnt toothed

Artikel-Nr. Cat. No.	Gesamtlänge Total length		
06-61-870	230 mm / 9"	CONE	1/1 Ø 4 mm 
06-61-871	230 mm / 9"	CONE	1/1 Ø 7 mm 
06-61-872	230 mm / 9"	CONE	1/1 Ø 9 mm 



1/3
CONE
06-61-872
230 mm
9"

Artikel-Nr. Cat. No.	Gesamtlänge Total length		
06-61-873	230 mm / 9"	CONE	1/1 Ø 4 mm 
06-61-874	230 mm / 9"	CONE	1/1 Ø 7 mm 
06-61-875	230 mm / 9"	CONE	1/1 Ø 9 mm 











1/3
CONE
06-61-875
230 mm
9"





2/3
COBB
06-11-582
 280 mm
 10¾"

		Artikel-Nr. Cat. No.	Gesamtlänge Total length
1/1 3,25 mm 	COBB	06-11-581	280 mm / 10¾" Fig. 000 gerade / straight
		06-11-591	gewinkelt / angled
1/1 4 mm 	COBB	06-11-582	280 mm / 10¾" Fig. 00 gerade / straight
		06-11-592	gewinkelt / angled
1/1 5 mm 	COBB	06-11-583	280 mm / 10¾" Fig. 0 gerade / straight
		06-11-593	gewinkelt / angled
1/1 6 mm 	COBB	06-11-584	280 mm / 10¾" Fig. 1 gerade / straight
		06-11-594	gewinkelt / angled
1/1 7,5 mm 	COBB	06-11-585	280 mm / 10¾" Fig. 2 gerade / straight
		06-11-595	gewinkelt / angled
1/1 9 mm 	COBB	06-11-586	280 mm / 10¾" Fig. 3 gerade / straight
		06-11-596	gewinkelt / angled
1/1 11,5 mm 	COBB	06-11-587	280 mm / 10¾" Fig. 4 gerade / straight
		06-11-597	gewinkelt / angled
1/1 13 mm 	COBB	06-11-588	280 mm / 10¾" Fig. 5 gerade / straight
		06-11-598	gewinkelt / angled
1/1 15,5 mm 	COBB	06-11-589	280 mm / 10¾" Fig. 6 gerade / straight
		06-11-599	gewinkelt / angled

Artikel-Nr. Cat. No.	Gesamtlänge Total length		
15-12-294	180 mm / 7" 4 mm	COTTLE	1/1
15-12-296	180 mm / 7" 6 mm		
15-12-298	180 mm / 7" 8 mm		
15-12-299	180 mm / 7" 10 mm		
15-12-300	180 mm / 7" 12 mm		
	graduiert graduated		
15-12-301	180 mm / 7" 4 mm	COTTLE	1/1
15-12-302	180 mm / 7" 6 mm		
15-12-303	180 mm / 7" 8 mm		
15-62-300	180 mm / 7" 10 mm		
15-12-304	180 mm / 7" 12 mm		
	graduiert graduated		
15-62-301	180 mm / 7" 4 mm	COTTLE	1/1
15-62-302	180 mm / 7" 6 mm		
15-62-303	180 mm / 7" 8 mm		
15-62-304	180 mm / 7" 10 mm		
15-62-305	180 mm / 7" 12 mm		
	graduiert graduated		



1/2
COTTLE
15-12-301
180 mm
7"

Artikel-Nr. Cat. No.	Gesamtlänge Total length		
15-12-307	180 mm / 7" 8 mm	COTTLE	1/1
	Fischschwanzosteotom, graduiert fishtail chisel, graduated		



1/2
COTTLE
15-12-307
180 mm
7"





1/2
SMITH-PETERSEN
13-02-659
 200 mm
 8"

		Artikel-Nr. Cat. No.	Gesamtlänge Total length
1/1		SMITH-PETERSEN 13-02-657	200 mm / 8" 6 mm
		13-02-658	200 mm / 8" 9 mm
		13-02-659	200 mm / 8" 13 mm
		13-02-660	200 mm / 8" 16 mm
		13-02-661	200 mm / 8" 19 mm
		13-02-662	200 mm / 8" 25 mm
		13-52-663	200 mm / 8" 32 mm



1/2
SMITH-PETERSEN
13-02-665
 200 mm
 8"

		Artikel-Nr. Cat. No.	Gesamtlänge Total length
1/1		SMITH-PETERSEN 13-02-663	200 mm / 8" 6 mm
		13-02-664	200 mm / 8" 9 mm
		13-02-665	200 mm / 8" 13 mm
		13-02-666	200 mm / 8" 16 mm
		13-02-667	200 mm / 8" 19 mm
		13-02-668	200 mm / 8" 25 mm
		13-02-669	200 mm / 8" 32 mm

Artikel-Nr. Cat. No.	Gesamtlänge Total length		
13-02-675	240 mm / 9½" 6 mm	HIBBS	1/1
13-02-676	240 mm / 9½" 10 mm		
13-02-677	240 mm / 9½" 13 mm		
13-02-678	240 mm / 9½" 16 mm		
13-02-679	240 mm / 9½" 19 mm		
13-02-680	240 mm / 9½" 22 mm		
13-02-681	240 mm / 9½" 25 mm		
13-02-682	240 mm / 9½" 28 mm		
13-02-683	240 mm / 9½" 32 mm		
13-02-684	240 mm / 9½" 38 mm		



1/2
HIBBS
13-02-677
240 mm
9½"

Artikel-Nr. Cat. No.	Gesamtlänge Total length		
13-02-685	240 mm / 9½" 6 mm	HIBBS	1/1
13-02-686	240 mm / 9½" 10 mm		
13-02-687	240 mm / 9½" 13 mm		
13-02-688	240 mm / 9½" 16 mm		
13-02-689	240 mm / 9½" 19 mm		
13-02-690	240 mm / 9½" 22 mm		
13-02-691	240 mm / 9½" 25 mm		
13-02-692	240 mm / 9½" 28 mm		
13-02-693	240 mm / 9½" 32 mm		
13-02-694	240 mm / 9½" 38 mm		



1/2
HIBBS
13-02-687
240 mm
9½"



 1/3
06-12-653
 245 mm
 9 3/4"

		Artikel-Nr. Cat. No.	Gesamtlänge Total length
1/1	LAMBOTTE	06-12-650	245 mm / 9 3/4" 4 mm
		06-12-651	245 mm / 9 3/4" 8 mm
		06-12-652	245 mm / 9 3/4" 10 mm
		06-12-653	245 mm / 9 3/4" 13 mm
		06-12-654	245 mm / 9 3/4" 15 mm
		06-12-655	245 mm / 9 3/4" 18 mm
		06-12-656	245 mm / 9 3/4" 20 mm
		06-12-658	245 mm / 9 3/4" 25 mm
		06-12-659	245 mm / 9 3/4" 30 mm
		06-12-660	245 mm / 9 3/4" 38 mm
		06-12-661	245 mm / 9 3/4" 44 mm
		06-12-662	245 mm / 9 3/4" 50 mm

 1/3
LAMBOTTE
06-12-785
 245 mm
 9 3/4"

		Artikel-Nr. Cat. No.	Gesamtlänge Total length
1/1	LAMBOTTE	06-12-781	245 mm / 9 3/4" 8 mm
		06-12-783	245 mm / 9 3/4" 13 mm
		06-12-785	245 mm / 9 3/4" 18 mm
		06-12-788	245 mm / 9 3/4" 25 mm
		06-12-789	245 mm / 9 3/4" 30 mm
		06-12-790	245 mm / 9 3/4" 38 mm

 1/3
OBWEGESER
04-15-720
 235 mm
 9 3/4"

		Artikel-Nr. Cat. No.	Gesamtlänge Total length
1/1	OBWEGESER	04-15-720	235 mm / 9 3/4" 11 mm

Artikel-Nr. Cat. No.	Gesamtlänge Total length		
06-12-512	205 mm / 8" 8 mm	STILLE	1/1
06-12-513	205 mm / 8" 10 mm		
06-12-514	205 mm / 8" 12 mm		
06-12-515	205 mm / 8" 15 mm		
06-12-516	205 mm / 8" 20 mm		
06-12-517	205 mm / 8" 25 mm		
Osteotome osteotomes			
06-12-523	205 mm / 8" 10 mm	STILLE	1/1
06-12-524	205 mm / 8" 12 mm		
06-12-525	205 mm / 8" 15 mm		
06-12-526	205 mm / 8" 20 mm		
06-12-527	205 mm / 8" 25 mm		
Osteotome osteotomes			



1/2
STILLE
06-12-516
 205 mm
 8"

Artikel-Nr. Cat. No.	Gesamtlänge Total length		
06-12-553	205 mm / 8" 10 mm	STILLE	1/1
06-12-554	205 mm / 8" 12 mm		
06-12-555	205 mm / 8" 15 mm		
06-12-556	205 mm / 8" 20 mm		
06-12-557	205 mm / 8" 25 mm		
Osteotome osteotomes			



1/2
STILLE
06-12-553
 205 mm
 8"



 1/2
STILLE
06-12-506
 205 mm
 8"

		Artikel-Nr. Cat. No.	Gesamtlänge Total length
	1/1	STILLE	06-12-503 205 mm / 8" 10 mm
			06-12-504 205 mm / 8" 12 mm
			06-12-505 205 mm / 8" 15 mm
			06-12-506 205 mm / 8" 20 mm
			06-12-507 205 mm / 8" 25 mm
			Flachmeißel <i>chisels</i>

 1/2
STILLE
06-12-576
 205 mm
 8"

		Artikel-Nr. Cat. No.	Gesamtlänge Total length
	1/1	STILLE	06-12-573 205 mm / 8" 10 mm
			06-12-574 205 mm / 8" 12 mm
			06-12-575 205 mm / 8" 15 mm
			06-12-576 205 mm / 8" 20 mm
			06-12-577 205 mm / 8" 25 mm
			Hohlmeißel <i>gouges</i>



Artikel-Nr. Cat. No.	Gesamtlänge Total length		
06-12-401	220 mm / 8¾" 5 mm	LEXER	1/1
06-12-402	220 mm / 8¾" 7 mm		
06-12-403	220 mm / 8¾" 10 mm		
06-12-405	220 mm / 8¾" 15 mm		
06-12-406	220 mm / 8¾" 20 mm		
06-12-407	220 mm / 8¾" 25 mm		
06-12-408	220 mm / 8¾" 30 mm		
Osteotome, mit Ferrozell-Griff <i>osteotomes, with handle from artificial wood</i>			



1/2
LEXER
06-12-405
 220 mm
 8¾"

Artikel-Nr. Cat. No.	Gesamtlänge Total length		
06-12-411	220 mm / 8¾" 5 mm	LEXER	1/1
06-12-412	220 mm / 8¾" 7 mm		
06-12-413	220 mm / 8¾" 10 mm		
06-12-415	220 mm / 8¾" 15 mm		
06-12-416	220 mm / 8¾" 20 mm		
06-12-417	220 mm / 8¾" 25 mm		
06-12-418	220 mm / 8¾" 30 mm		
Hohlmeißel, mit Ferrozell-Griff <i>gouges, with handle from artificial wood</i>			



1/2
LEXER
06-12-415
 220 mm
 8¾"







 1/2
06-12-438
 235 mm
 9¼"

		Artikel-Nr. Cat. No.	Gesamtlänge Total length
1/1 8 mm 		06-12-437	235 mm / 9¼" 6 mm
		06-12-438	235 mm / 9¼" 8 mm
		06-12-439	235 mm / 9¼" 11 mm
		06-12-440	235 mm / 9¼" 16 mm
		Wirbelsäulenmeißel, bajonettförmig, mit Ferrozell-Griff <i>lamina gouge, bajonet-shaped, with handle from artificial wood</i>	

 1/2
ZIELKE
06-12-702
 230 mm
 9"

		Artikel-Nr. Cat. No.	Gesamtlänge Total length
1/1 ZIELKE 		06-12-701	230 mm / 9" 5,5 mm
		06-12-702	230 mm / 9" 9 mm
		Hohlmeißel, gebogen, mit Ferrozell-Griff <i>gouges, curved with handle from artificial wood</i>	



Artikel-Nr. Cat. No.	Gesamtlänge Total length		
06-62-705	280 mm / 11"	gerade <i>straight</i>	COBB 1/1 
06-62-706	280 mm / 11"	leicht gebogen <i>slightly curved</i>	COBB 1/1 
06-62-707	280 mm / 11"	stark gebogen <i>full curved</i>	COBB 1/1 
06-62-708	280 mm / 11"	rückwärts gebogen <i>reverse curved</i>	COBB 1/1 



1/2
COBB
06-62-705
 280 mm
 11"



Artikel-Nr.
Cat. No.

06-62-000	K-LINE MAGNUM Flachmeißel Set, bestehend aus: K-LINE MAGNUM Chisel Set, consisting of: K-LINE MAGNUM Flachmeißel, 273 mm / 10¾", Griff ø 32 mm K-LINE MAGNUM chisel, 273 mm / 10¾", handle ø 32 mm
06-62-001	6 mm
06-62-002	10 mm
06-62-003	15 mm
06-62-004	20 mm
06-62-005	25 mm
06-62-006	30 mm
	gerade straight
06-62-007	Sterilisiergestell für 6 K-LINE MAGNUM Instrumente mit Griff ø 32 mm <i>sterilizing rack for 6 K-LINE MAGNUM instruments with handle ø 32 mm</i>

 1/4
06-62-000
Artikel-Nr.
Cat. No.

06-62-008	K-LINE MAGNUM Flachmeißel Set, bestehend aus: K-LINE MAGNUM Chisel Set, consisting of: K-LINE MAGNUM Flachmeißel, 273 mm / 10¾", Griff ø 32 mm K-LINE MAGNUM chisel, 273 mm / 10¾", handle ø 32 mm
06-62-009	6 mm
06-62-010	10 mm
06-62-011	15 mm
06-62-012	20 mm
06-62-013	25 mm
06-62-014	30 mm
	gebogen curved
06-62-007	Sterilisiergestell für 6 K-LINE MAGNUM Instrumente mit Griff ø 32 mm <i>sterilizing rack for 6 K-LINE MAGNUM instruments with handle ø 32 mm</i>



Artikel-Nr. Cat. No.	Gesamtlänge Total length		
06-62-001	273 mm / 10¾"	6 mm	
	gerade straight		
06-62-002	273 mm / 10¾"	10 mm	
	gerade straight		
06-62-003	273 mm / 10¾"	15 mm	
	gerade straight		
06-62-004	273 mm / 10¾"	20 mm	
	gerade straight		
06-62-005	273 mm / 10¾"	25 mm	
	gerade straight		
06-62-006	273 mm / 10¾"	30 mm	
	gerade straight		

Artikel-Nr. Cat. No.	Gesamtlänge Total length		
06-62-009	273 mm / 10¾"	6 mm	
	gebogen curved		
06-62-010	273 mm / 10¾"	10 mm	
	gebogen curved		
06-62-011	273 mm / 10¾"	15 mm	
	gebogen curved		
06-62-012	273 mm / 10¾"	20 mm	
	gebogen curved		
06-62-013	273 mm / 10¾"	25 mm	
	gebogen curved		
06-62-014	273 mm / 10¾"	30 mm	
	gebogen curved		

Artikel-Nr. Cat. No.		
06-62-007	Sterilisiergestell für 6 K-LINE MAGNUM Instrumente mit Griff ø 32 mm sterilizing rack for 6 K-LINE MAGNUM instruments with handle ø 32 mm	





1/2
06-62-002
273 mm
10¾"



 1/4
06-61-630
Artikel-Nr.
Cat. No.

Artikel-Nr.	Cat. No.	Description
06-61-630		K-LINE MAGNUM XL Küretten Set, bestehend aus: K-LINE MAGNUM XL Curettes Set, consisting of:
		K-LINE MAGNUM Kürette, extra lang (XL), 337 mm / 13¼", Griff ø 32 mm
		K-LINE MAGNUM curette, extra long (XL), 337 mm / 13¼", handle ø 32 mm
06-61-631	7 mm	gerade / straight
06-61-632	9 mm	gerade / straight
06-61-633	11 mm	gerade / straight
06-61-634	13 mm	gerade / straight
06-61-635	15 mm	gerade / straight
06-61-636	17 mm	gerade / straight
06-61-637	19 mm	gerade / straight
06-61-638	7 mm	vorwärts gewinkelt / forward angled
06-61-639	9 mm	vorwärts gewinkelt / forward angled
06-61-640	11 mm	vorwärts gewinkelt / forward angled
06-61-641	7 mm	rückwärts gewinkelt / reverse angled
06-61-642	9 mm	rückwärts gebogen / reverse angled
06-61-643		Sterilisiergestell für 12 K-LINE MAGNUM Instrumente mit Griff ø 32 mm sterilizing case for 12 K-LINE MAGNUM instruments with handle ø 32 mm

Artikel-Nr. Cat. No.	Gesamtlänge Total length		
06-61-631	337 mm / 13¼"	7 mm	
	gerade / straight		
06-61-632	337 mm / 13¼"	9 mm	
	gerade / straight		
06-61-633	337 mm / 13¼"	11 mm	
	gerade / straight		
06-61-634	337 mm / 13¼"	13 mm	
	gerade / straight		
06-61-635	337 mm / 13¼"	15 mm	
	gerade / straight		
06-61-636	337 mm / 13¼"	17 mm	
	gerade / straight		
06-61-637	337 mm / 13¼"	19 mm	
	gerade / straight		
06-61-638	337 mm / 13¼"	7 mm	
	vorwärts gebogen / forward angled		
06-61-639	337 mm / 13¼"	9 mm	
	vorwärts gebogen / forward angled		
06-61-640	337 mm / 13¼"	11 mm	
	vorwärts gebogen / forward angled		
06-61-641	337 mm / 13¼"	7 mm	
	rückwärts gebogen / reverse angled		
06-61-642	337 mm / 13¼"	9 mm	
	rückwärts gebogen / reverse angled		



Artikel-Nr. Cat. No.			
06-61-643	Sterilisiergestell für 12 K-LINE MAGNUM Instrumente mit Griff ø 32 mm <i>sterilizing case for 12 K-LINE MAGNUM instruments with handle ø 32 mm</i>		



1/2
06-61-634
337 mm
13¼"

 1/4
06-61-660
Artikel-Nr.
Cat. No.
06-61-660
K-LINE MAGNUM Küretten Set, bestehend aus:
K-LINE MAGNUM Curettes Set, consisting of:

 K-LINE MAGNUM Kürette, 320 mm / 12²/₃" , Griff ø 28 mm
 K-LINE MAGNUM curette, 320 mm / 12²/₃" , handle ø 28 mm

06-61-661	7 mm
	gerade / straight
06-61-662	9 mm
	gerade / straight
06-61-663	11 mm
	gerade / straight
06-61-664	13 mm
	gerade / straight
06-61-665	15 mm
	gerade / straight
06-61-666	17 mm
	gerade / straight
06-61-667	19 mm
	gerade / straight
06-61-668	7 mm
	vorwärts gebogen / forward angled
06-61-669	9 mm
	vorwärts gebogen / forward angled
06-61-670	11 mm
	vorwärts gebogen / forward angled
06-61-671	7 mm
	rückwärts gebogen / reverse angled
06-61-672	9 mm
	rückwärts gebogen / reverse angled
06-61-657	Sterilisiergestell für 12 K-LINE MAGNUM Instrumente mit Griff ø 28 mm
	sterilizing case for 12 K-LINE MAGNUM instruments with handle ø 28 mm



Artikel-Nr. Cat. No.	Gesamtlänge Total length		
06-61-661	320 mm / 12 ² / ₃ "	7 mm	
	gerade / <i>straight</i>		
06-61-662	320 mm / 12 ² / ₃ "	9 mm	
	gerade / <i>straight</i>		
06-61-663	320 mm / 12 ² / ₃ "	11 mm	
	gerade / <i>straight</i>		
06-61-664	320 mm / 12 ² / ₃ "	13 mm	
06-61-665	320 mm / 12 ² / ₃ "	15 mm	
	gerade / <i>straight</i>		
06-61-666	320 mm / 12 ² / ₃ "	17 mm	
	gerade / <i>straight</i>		
06-61-667	320 mm / 12 ² / ₃ "	19 mm	
	gerade / <i>straight</i>		
06-61-668	320 mm / 12 ² / ₃ "	7 mm	
	vorwärts gebogen / <i>forward angled</i>		
06-61-669	320 mm / 12 ² / ₃ "	9 mm	
	vorwärts gebogen / <i>forward angled</i>		
06-61-670	320 mm / 12 ² / ₃ "	11 mm	
	vorwärts gebogen / <i>forward angled</i>		
06-61-671	320 mm / 12 ² / ₃ "	7 mm	
	rückwärts gebogen / <i>reverse angled</i>		
06-61-672	320 mm / 12 ² / ₃ "	9 mm	
	rückwärts gebogen / <i>reverse angled</i>		



Artikel-Nr.
Cat. No.

06-61-657	Sterilisiergestell für 12 K-LINE MAGNUM Instrumente mit Griff ø 28 mm <i>sterilizing case for 12 K-LINE MAGNUM instruments with handle ø 28 mm</i>	
-----------	---	--

1/2
06-61-669
320 mm
12²/₃"



1/4
06-61-680

Artikel-Nr.
Cat. No.

06-61-680 K-LINE MAGNUM Ring-Küretten Set, bestehend aus:
K-LINE MAGNUM Ring Curettes Set, consisting of:

K-LINE MAGNUM Ring-Kürette, extra lang (XL),
 337 mm / 13¼", Griff ø 32 mm

*K-LINE MAGNUM ring curette, extra long (XL),
 337 mm / 13¼", handle ø 32 mm*

06-61-681 6 mm

gerade / straight

06-61-682 8 mm

gerade / straight

06-61-683 10 mm

gerade / straight

06-61-684 6 mm

gebogen / curved

06-61-685 8 mm

gebogen / curved

06-61-686 10 mm

gebogen / curved

06-61-643 Sterilisiergestell für 12 K-LINE MAGNUM
 Instrumente mit Griff ø 32 mm

*sterilizing case for 12 K-LINE MAGNUM
 instruments with handle ø 32 mm*



Artikel-Nr. Cat. No.	Gesamtlänge Total length		
06-61-681	337 mm / 13¼"	6 mm	
	gerade / straight		
06-61-682	337 mm / 13¼"	8 mm	
	gerade / straight		
06-61-683	337 mm / 13¼"	10 mm	
	gerade / straight		
06-61-684	337 mm / 13¼"	6 mm	
	gebogen / curved		
06-61-685	337 mm / 13¼"	8 mm	
	gebogen / curved		
06-61-686	337 mm / 13¼"	10 mm	
	gebogen / curved		

Artikel-Nr. Cat. No.		
06-61-643	Sterilisiergestell für 12 K-LINE MAGNUM Instrumente mit Griff ø 32 mm sterilizing case for 12 K-LINE MAGNUM instruments with handle ø 32 mm	



1/2
06-61-685
337 mm
13¼"





1/4
06-61-650

Artikel-Nr.
Cat. No.

06-61-650 K-LINE MAGNUM Ring-Küretten Set, bestehend aus:
K-LINE MAGNUM Ring Curettes Set, consisting of:

K-LINE MAGNUM Ring-Kürette, 320 mm / 12²/₅" ,
 Griff ø 28 mm

*K-LINE MAGNUM ring curette, 320 mm / 12²/₅" ,
 handle ø 28 mm*

06-61-651 6 mm
 gerade / straight

06-61-652 8 mm
 gerade / straight

06-61-653 10 mm
 gerade / straight

06-61-654 6 mm
 gebogen / curved

06-61-655 8 mm
 gebogen / curved

06-61-656 10 mm
 gebogen / curved

06-61-657 Sterilisiergestell für 12 K-LINE MAGNUM
 Instrumente mit Griff ø 28 mm

*sterilizing case for 12 K-LINE MAGNUM
 instruments with handle ø 28 mm*



Artikel-Nr. Cat. No.	Gesamtlänge Total length		
06-61-651	320 mm / 12 ² / ₃ "	6 mm	
	gerade / straight		
06-61-652	320 mm / 12 ² / ₃ "	8 mm	
	gerade / straight		
06-61-653	320 mm / 12 ² / ₃ "	10 mm	
	gerade / straight		
06-61-654	320 mm / 12 ² / ₃ "	6 mm	
	gebogen / curved		
06-61-655	320 mm / 12 ² / ₃ "	8 mm	
	gebogen / curved		
06-61-656	320 mm / 12 ² / ₃ "	10 mm	
	gebogen / curved		

Artikel-Nr. Cat. No.		
06-61-657	Sterilisiergestell für 12 K-LINE MAGNUM Instrumente mit Griff ø 28 mm sterilizing case for 12 K-LINE MAGNUM instruments with handle ø 28 mm	



1/2
06-61-652
320 mm
12²/₃"





1/4
06-62-015

Artikel-Nr.
Cat. No.

06-62-015 **K-LINE MAGNUM COBB Elevatoren Set, bestehend aus:**
K-LINE MAGNUM COBB Elevators Set, consisting of:

K-LINE MAGNUM COBB Elevatorium, extra lang (XL),
 337 mm / 13¼", Griff ø 32 mm

*K-LINE MAGNUM COBB elevators, extra long (XL),
 337 mm / 13¼", handle ø 32 mm*

06-62-016 10 mm

06-62-017 15 mm

06-62-018 20 mm

06-62-019 25 mm

06-62-020 30 mm

06-62-021 35 mm

06-61-643 Sterilisiergestell für 12 K-LINE MAGNUM
 Instrumente mit Griff ø 32 mm

*sterilizing case for 12 K-LINE MAGNUM
 instruments with handle ø 32 mm*

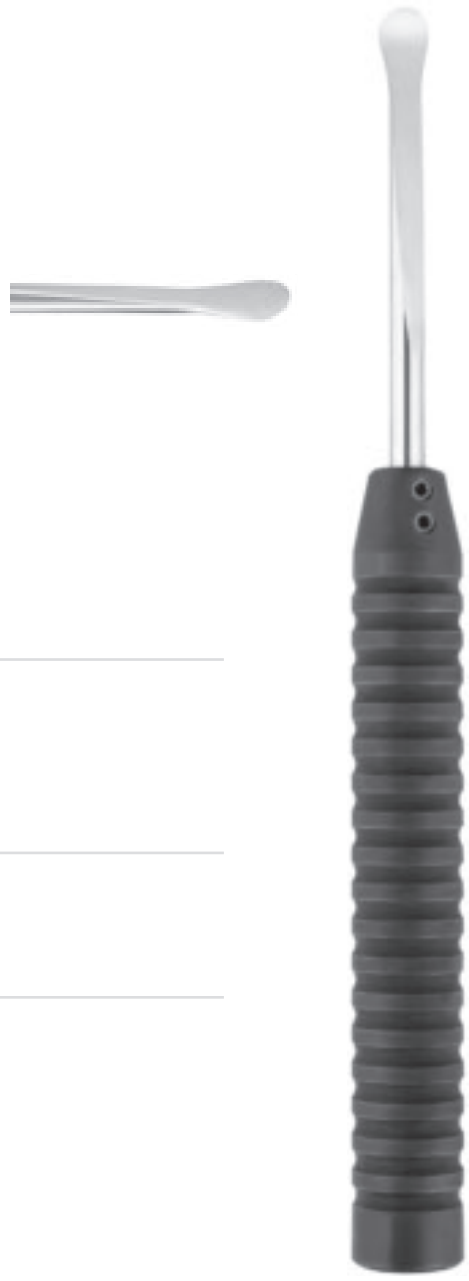
Artikel-Nr. Cat. No.	Gesamtlänge Total length			
06-62-016	337 mm / 13¼"	COBB	10 mm	
06-62-017	337 mm / 13¼"	COBB	15 mm	
06-62-018	337 mm / 13¼"	COBB	20 mm	
06-62-019	337 mm / 13¼"	COBB	25 mm	
06-62-020	337 mm / 13¼"	COBB	30 mm	
06-62-021	337 mm / 13¼"	COBB	35 mm	

Artikel-Nr. Cat. No.			
06-61-643	Sterilisiergestell für 12 K-LINE MAGNUM Instrumente mit Griff ø 32 mm <i>sterilizing case for 12 K-LINE MAGNUM instruments with handle ø 32 mm</i>		

1/2
06-62-017
337 mm
13¼"





1/4
 06-62-022

Artikel-Nr.
Cat. No.

06-62-022 **K-LINE MAGNUM COBB Elevatoren Set, bestehend aus:**
K-LINE MAGNUM COBB Elevators Set, consisting of:

K-LINE MAGNUM COBB Elevatorium, 320 mm / 12 $\frac{2}{3}$ " ,
 Griff ø 28 mm

*K-LINE MAGNUM COBB elevators, 320 mm / 12 $\frac{2}{3}$ " ,
 handle ø 28 mm*

06-62-023 10 mm

06-62-024 15 mm

06-62-025 20 mm

06-62-026 25 mm

06-62-027 30 mm

06-62-028 35 mm

06-61-657 Sterilisiergestell für 12 K-LINE MAGNUM
 Instrumente mit Griff ø 28 mm

*sterilizing case for 12 K-LINE MAGNUM
 instruments with handle ø 28 mm*

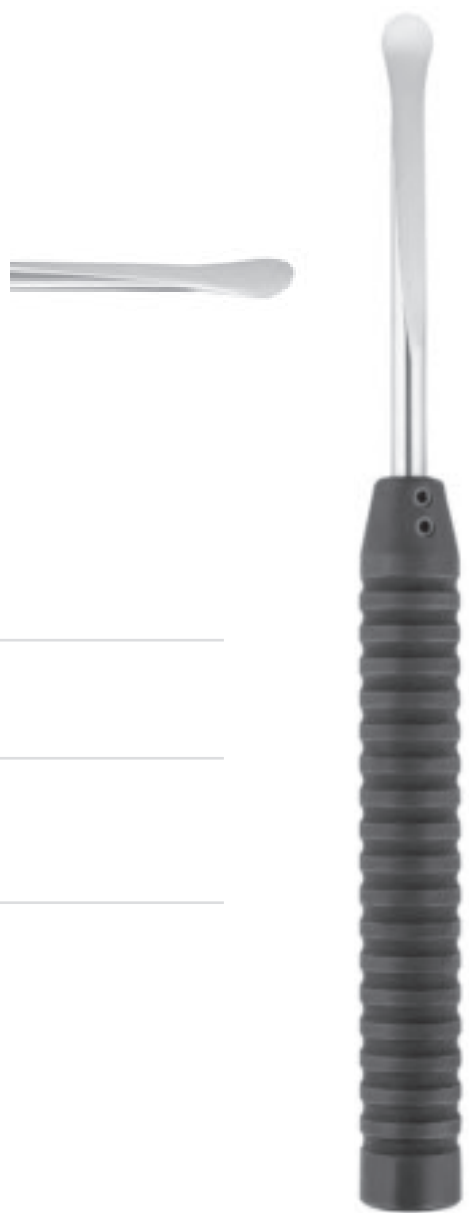

Artikel-Nr. Cat. No.	Gesamtlänge Total length			
06-62-023	320 mm / 12 ² / ₃ "	COBB	10 mm	
06-62-024	320 mm / 12 ² / ₃ "	COBB	15 mm	
06-62-025	320 mm / 12 ² / ₃ "	COBB	20 mm	
06-62-026	320 mm / 12 ² / ₃ "	COBB	25 mm	
06-62-027	320 mm / 12 ² / ₃ "	COBB	30 mm	
06-62-028	320 mm / 12 ² / ₃ "	COBB	35 mm	

Artikel-Nr. Cat. No.			
06-61-657	Sterilisiergestell für 12 K-LINE MAGNUM Instrumente mit Griff ø 28 mm <i>sterilizing case for 12 K-LINE MAGNUM instruments with handle ø 28 mm</i>		

1/2
06-62-025
320 mm
12²/₃"





1/2
06-62-030
 240 mm
 9½"

		Artikel-Nr. Cat. No.	Gesamtlänge Total length
		06-62-030	240 mm / 9½" ø 25 mm, 193 g
		06-62-031	245 mm / 9½" ø 32 mm, 340 g



Artikel-Nr. Cat. No.	Gesamtlänge Total length		
06-12-036	185 mm / 7¼"		
	ø 25 mm, 130 g mit auswechselbaren Kunststoffbacken with interchangeable plastic discs		
06-12-037	Paar Ersatzbacken pair of spare discs		



1/2
06-12-036
185 mm
7¼"



1/2
COTTLE
06-12-038
180 mm
7"

Artikel-Nr. Cat. No.	Gesamtlänge Total length		
06-12-038	180 mm / 7"	COTTLE	
	ø 30 mm, 240 g 1 Seite flach, 1 Seite convex 1 side flat, 1 side convex		

Artikel-Nr. Cat. No.	Gesamtlänge Total length		
06-12-044	220 mm / 8¾"	HAJEK	
	ø 27 mm, 130 g		



1/2
HAJEK
06-12-044
220 mm
8¾"

 1/2
04-06-112
 165 mm
 6½"

Artikel-Nr.
Cat. No.
Gesamtlänge
Total length

		04-06-112	165 mm / 6½"
			ø 22 mm, 80 g
			mit Bleifüllung lead filled head

 1/2
04-06-114
 190 mm
 7½"

Artikel-Nr.
Cat. No.
Gesamtlänge
Total length

		04-06-114	190 mm / 7½"
			ø 22 mm, 155 g
			mit Bleifüllung lead filled head

 1/2
 MEAD
06-12-035
 190 mm
 7½"

Artikel-Nr.
Cat. No.
Gesamtlänge
Total length

	MEAD	06-12-035	190 mm / 7½"
			ø 20 mm, 180 g
			mit auswechselbaren Kunststoffbacken with interchangeable plastic discs
		06-12-034	Paar Ersatzbacken pair of spare discs



Artikel-Nr. Cat. No.	Gesamtlänge Total length		
06-12-045	250 mm / 10"		
	ø 30 mm, 200 g mit auswechselbaren Kunststoffbacken <i>with interchangeable plastic discs</i>		
06-12-047	Paar Ersatzbacken <i>pair of spare discs</i>		



1/2
06-12-045
250 mm
10"

Artikel-Nr. Cat. No.	Gesamtlänge Total length		
06-62-700	180 mm / 7"	GERZOG	
	ø 25 mm, 250 g mit Bleifüllung <i>lead filled head</i>		



1/2
GERZOG
06-62-700
180 mm
7"





TC

		Artikel-Nr. Cat. No.	Gesamtlänge Total length
1/1		15-12-421	205 mm / 8" Hartmetall-Zähne, Fig. 1/2 carbide inserts teeth, fig. 1/2
1/1		15-12-423	205 mm / 8" Hartmetall-Zähne, Fig. 3/4 carbide inserts teeth, fig. 3/4
1/1		15-12-425	205 mm / 8" Hartmetall-Zähne, Fig. 5/6 carbide inserts teeth, fig. 5/6
1/1		15-12-427	205 mm / 8" Hartmetall-Zähne, Fig. 7/8 carbide inserts teeth, fig. 7/8
1/1		15-12-429	205 mm / 8" Hartmetall-Zähne, Fig. 9/10 carbide inserts teeth, fig. 9/10

 1/1
 15-12-421
 205 mm
 8"

Area with horizontal lines for notes.





Mikro-Neurochirurgische Instrumente
Micro-Neurosurgical Instruments

HF-Instrumente und Zubehör
HF Instruments and Accessoires

Kopf-Schädelinstrumente und Haltesysteme
Head-Cranio Instruments and Holding Systems

Aneurysmen-Clip System
Aneurysm Clip System

Schädel-Verplattung
Cranial Plate System

Hypophysektomie-Instrumente
Pituitary Instruments

Instrumente für die Wirbelsäule, Wundspreizer
Spine Instruments, Self-retaining Retractors

Laminektomie-Stanzen, Rongeure, Hohlmeißelzangen
Laminectomy Punches, Rongeurs

Gefäß- und Bulldogklemmen, Gefäß-Clips
Vessel- and Bulldog-Clamps, Vessel Clips

Allgemeinchirurgische Instrumente
General Surgical Instruments

Siehe separate Anlage
Please see the separate enclosure

/// Alphabetischer Index, Numerischer Index
Alphabetical Index, Numerical Index



REBSTOCK®
Precision made in Germany

**SURGICAL
INSTRUMENTS
MICRO-NEURO-SPINE**

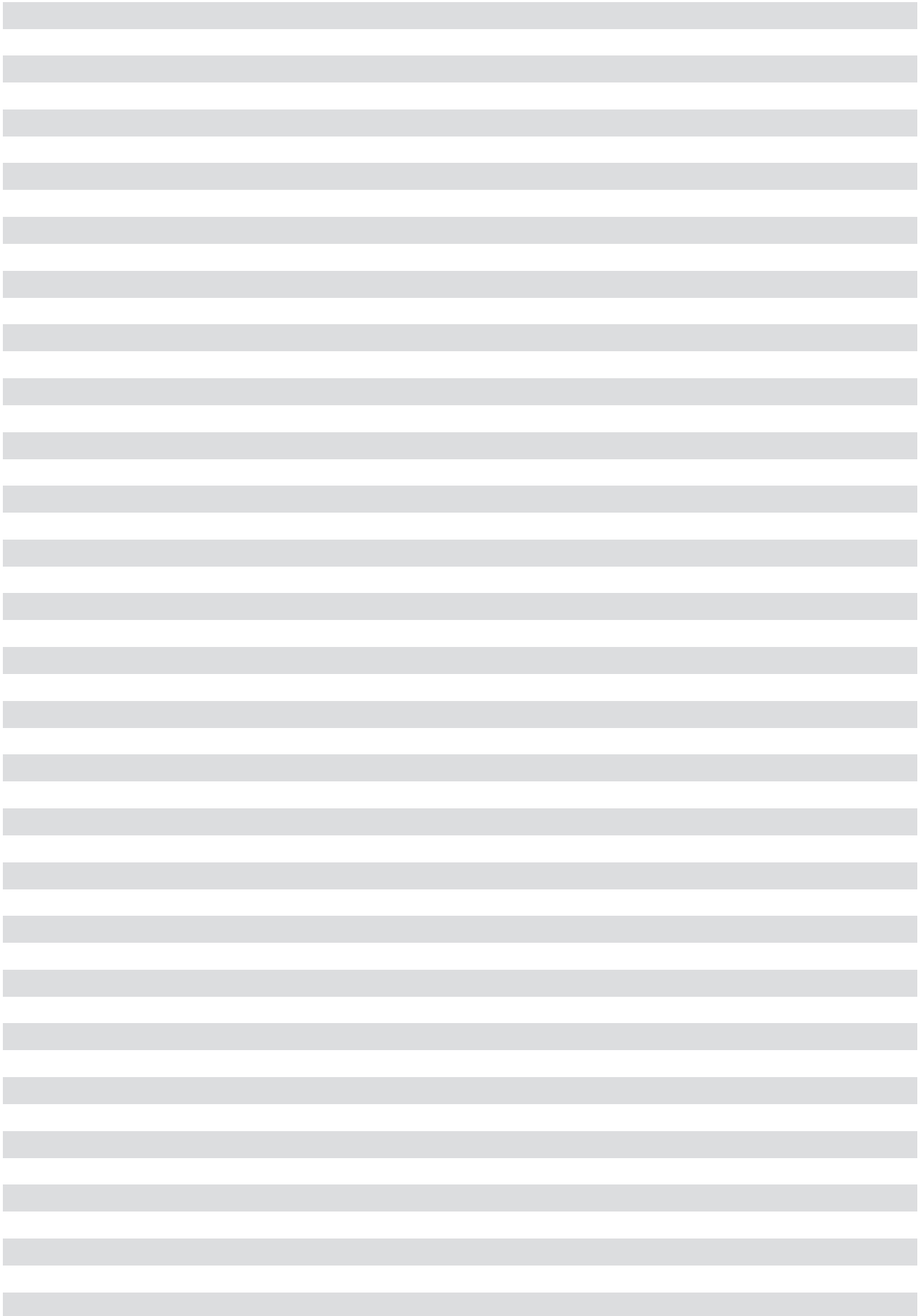

A series of horizontal grey lines for writing notes, arranged in a regular grid pattern across the page.

SURGICAL
INSTRUMENTS
MICRO-NEURO-SPINE

© Copyright by Rebstock Instruments GmbH. Alle Rechte vorbehalten. Nachdruck, auch auszugsweise, verboten. Kein Teil dieses Katalogs darf ohne schriftliche Genehmigung der Firma Rebstock Instruments GmbH in irgendeiner Form reproduziert oder unter Verwendung elektronischer Systeme verarbeitet, vervielfältigt oder verbreitet werden.
Modell- und technische Änderungen vorbehalten.

© Copyright by Rebstock Instruments GmbH. All rights reserved. Full or partial reproduction prohibited. No part of this catalogue may be reproduced, processed or transmitted in any form or manner, electronic or mechanical without written permission of Rebstock Instruments GmbH.
Models and technical specifications are subject to change.

REBSTOCK®
Precision made in Germany

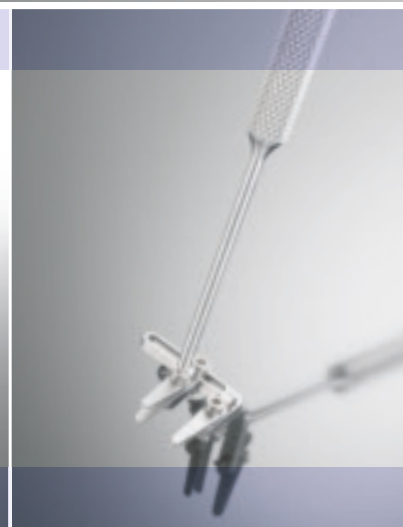
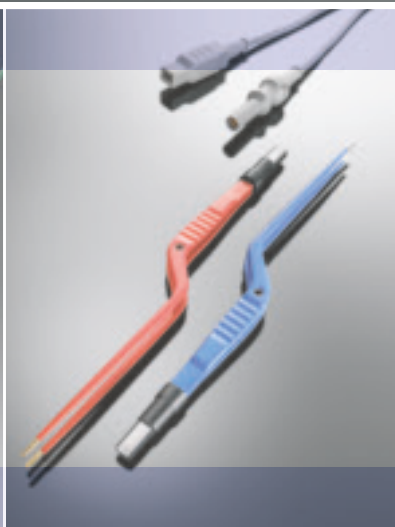
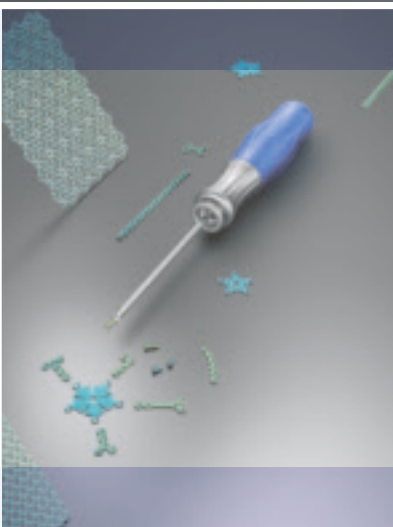

REBSTOCK INSTRUMENTS GMBH
IN WEIHERÄCKER 7
D-78589 DÜRBHEIM / TUTTLINGEN

TEL +49 7424 6734
FAX +49 7424 4334

www.rebstock.de
info@rebstock.de